

# DON-JO MFG., INC.

## ARCHITECTURAL HARDWARE & ACCESSORIES

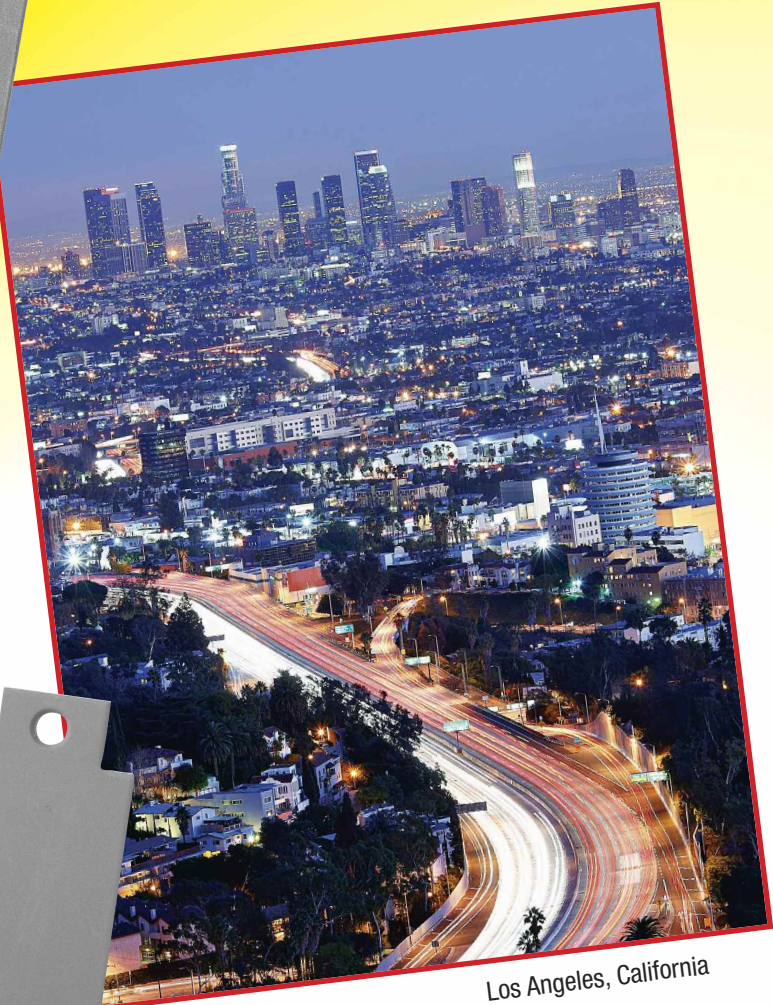

Los Angeles, California

# FILLER PLATES, MOUNTING TABS & SIGNS

DON-JO MFG., INC.  
P.O. Box 929  
Sterling, MA 01564

PHONE: 978.422.3377  
FAX: 978.422.3467  
WATS: 800.628.8389  
WATS FAX: 800.278.8202

WEB: [www.don-jo.com](http://www.don-jo.com)  
E-mail: [info@don-jo.com](mailto:info@don-jo.com)  
Section H, Version 1



# INDEX

Item#	Page#	Item#	Page#	Item#	Page#	Item#	Page#
534-MWA	7h	DCB-340	5h	HR-110	4h	HS-9070-06	10h
834-ADJ	7h	DCB-350	5h	HR-120	4h	HS-9070-07	10h
AF-29	3h	DD-1	9h	HR-130	4h	HS-9070-08	10h
AF-29L	3h	DD-2	9h	HR-150	4h	HS-9070-22	10h
AF-260	3h	DD-3	9h	HR-160	4h	HS-9070-24	10h
AF-261	3h	DD-4	9h	HR-170	4h	HS-9070-27	10h
AF-291	3h	DD-5	9h	HR-180	4h	HS-9070-32	10h
AF-291L	3h	DD-6	9h	HR-190	4h	HS-9070-34	10h
AR-335	2h	DD-7	9h	HR-200-4	4h	HS-9070-35	10h
AR-9K	2h	DD-8	9h	HR-210-5	4h	HS-9070-46	9h
BF-135	2h	EF-86	1h	HR-215-4	4h	HS-9070-47	9h
BF-161	2h	EF-160	1h	HR-216-5	4h	HS-9070-48	9h
BF-178	2h	EF-161	1h	HR-217	4h	HS-9080-02	10h
BTS-160	1h	EF-161-S	1h	HR-218	4h	HS-9090-01	10h
CHS-1	9h	EF-161-TG	1h	HS-050	1h	HS-9090-05	10h
CHS-2	9h	EF-634	1h	HS-060	1h	HS-9090-32	10h
CHS-3	9h	EL-86	2h	HS-080	1h	LSP-1	3h
CHS-4	9h	EPT-1	1h	HS-090	1h	LW-86	1h
CHS-5	9h	FB-225	1h	HS-9050-01	10h	MAF-261	3h
CHS-6	9h	FBG-I-D	6h	HS-9050-05	10h	MWA-1	7h
CHS-7	9h	FBG-I-SQ	6h	HS-9050-32	10h	MWAP	7h
CHS-8	9h	FBT-1	6h	HS-9060-01	10h	PDF-161	2h
CP-258	2h	FBRK-2	3h	HS-9060-02	10h	PSA	6h
CR-060	8h	FBRK-3	3h	HS-9060-03	10h	SA-615	5h
CR-125	8h	FBR-A	1h	HS-9060-04	10h	SA-618	5h
CR-275	8h	FBR-B	1h	HS-9060-05	10h	SHF-50	1h
CR-300	8h	FBR-C	1h	HS-9060-22	10h	SHF-45	1h
CSPB-30	7h	FF-45	1h	HS-9060-24	10h	SMAF-261	3h
CSPB-50	7h	FF-50	1h	HS-9060-32	10h	SPB-30	7h
CSPB-80	7h	FPK-86	3h	HS-9060-35	10h	SPB-60	7h
CV-86	2h	FPK-161	3h	HS-9060-36	10h	SPB-80	7h
CV-2414	2h	FS-260	1h	HS-9060-37	10h	ST-386	2h
CV-8624	2h	GS-10-G	6h	HS-9070-01	10h	TB-215	6h
CVRL	2h	GS-10-PC	6h	HS-9070-02	10h	TL-1	8h
DBS-386	2h	HD-1	9h	HS-9070-03	10h	TL-2	8h
DCB-270	5h	HF-45	1h	HS-9070-04	10h	TL-3	8h
DCB-280	5h	HR-100	4h	HS-9070-05	10h		

# FASTENERS

Product	Fastening Type
AF-260 & AF-261, AF-29 & AF-291, AF-29L & AF-291L	2 ea. 12-24 x 3/4" Flat Head Combo Screw
BTS-160, FB-225, EF-160, EF-161, EF-161-TG, EF-161-S, EF-634	2 ea. #8-32 x 1/2" FHMS
FF-45 & FF-50, FS-260, DBS-386, ST-386, CV-86, CV-8624, EF-86, LW-86, EL-86, SFF-50, HF-45, SHF-45	2 ea. #12-24 x 1/2" FHMS
EPT-1	2 ea. #10-24 x 1/2" FHMS
CV-2414, CVRL	2 ea. #10 x 1 1/2" FHSMS
BF-161, BF-178, BF-135, PDF-161	1 ea. #10-32 x 1 1/2" FHMS
TL-1, TL-3	2 ea. #12-24 x 1/2" FHSMS, 2 ea. #8-32 x 1/2" FHMS
TL-2	4 ea. #12-24 x 1/2" FHMS

**FILLER PLATES**



**BTS-160-PC**  
T-strike with I60  
cut out

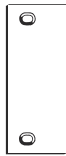

**FF-45**  
**FF-50**  
Frame hinge  
cut out



**FS-260-PC**  
ANSI strike  
cut out



**EPT-I**  
Fill holes left  
by electric  
power transfer

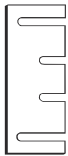

**HS-060**  
16 (.060) Gauge  
Hinge shim



**HS-050**  
16 (.060) Gauge  
Hinge shim



**FBR-A**

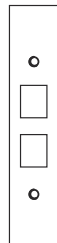

**FBR-B**



**FBR-C**

NUMBER	DIMENSIONS	MATERIAL
BTS-160	2 3/4" x 1 3/8"	Steel
EPT-I	9" x 1 1/4"	
FBR-A	3 7/8" x 1"	
FBR-B	5 7/8" x 1 1/4"	
FBR-C	3 7/8" x 1"	
FF-45	4 1/2" x 1 5/8"	
FF-50	5" x 1 5/8"	
FS-260	4 7/8" x 1 1/4"	
HS-050	4 1/2" x 1/2"	
HS-060	4 1/2" x 1 5/8"	
HS-080	4 1/2" x 1/2"	Steel
HS-090	4 1/2" x 1 5/8"	

**SHELF PACK: 10** Polybagged  
**FINISH: PC (Prime Coated)**

**FILLER PLATES**



**EF-86**  
**LW-86**  
86 cut out



**EF-160**  
160 cut out  
**EF-161**  
161 cut out



**EF-634**  
Flush bolt  
cut out



**FB-225**  
Flush bolt  
strike filler



**HF-45**  
**SHF-45**  
**SHF-50**  
Door hinge  
cut out

NUMBER	DIMENSIONS	MATERIAL
EF-86	8" x 1 1/4" x 3/16"	Steel
EF-160	2 1/4" x 1"	
EF-161	2 1/4" x 1 1/8"	
EF-161-S	2 3/4" x 1 1/8"	
EF-161-TG	2 1/4" x 1 1/8"	
EF-634	6 3/4" x 1"	
FB-225	2 1/4" x 15/16"	
HF-45	4 1/2" x 1 3/4"	
LW-86	8" x 1 1/4" x 1/4"	
SHF-45	4 1/2" x 1 1/2"	
SHF-50	5" x 1 1/2"	

**SHELF PACK: 10** Polybagged  
**FINISHES:** (EF-86, EF-634, LW-86, FB-225, HF-45, SHF-45, EF-161-S, EF-161-TG, SHF-50) **PC (Prime Coated)**, (EF-160, EF-161) **BP (Brass Plated)**, **CP (Chrome Plated)**, **PC (Prime Coated)**,

CONVERSION PLATES



**CV-86**  
Converts 86  
cut out to I61



**CV-2414**  
Converts Sargent's  
Integra locks



**CV-8624**  
Converts 86  
cut out to (2) I61

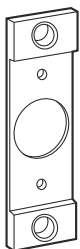

**CVRL**  
Converts 3 3/8" x 1"  
roller latch to a  
standard latch prep



**DBS-386**  
Deadbolt strike  
for 86 cut out  
Use with pair of  
doors



**EL-86**  
Converts mortise  
to electronic  
lock



**ST-386-PC**  
Use with pair of  
86 cut out doors  
Apply ANSI strike  
over Reversible

NUMBER	DIMENSIONS	MATERIAL
CV-86	8" x 1 1/4"	Steel
CV-2414	4 1/4" x 1 1/4"	Steel
CV-8624	8" x 1 1/4"	Steel
CVRL	3 3/8" x 1"	Steel
DBS-386	8" x 1 1/4"	Aluminum
EL-86	8" x 1 1/4"	Steel
ST-386-PC	8" x 1 1/4"	Aluminum

**SHELF PACK: 10** Polybagged  
**FINISHES:** (CV-86, CVRL, CV-8624, DBS-386, EL-86  
 ST-386) **PC (Prime Coated)**  
 (CV-2414) **SL (Silver Coated)**

HOLE FILLER PLATES

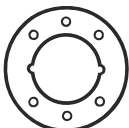

**AR-335**  
Allows for use of levers  
on 1 3/8" door

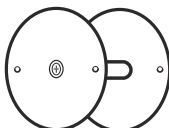

**BF-135**  
Covers up to 3 3/4" hole

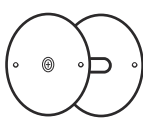

**BF-161**  
Covers up to 2 1/8" hole

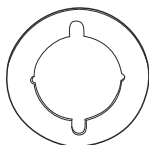

**AR-9K**  
Allows for use of levers  
on 1 3/8" door

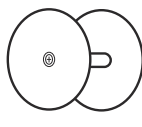

**BF-178**  
Covers up to 1 1/2" hole

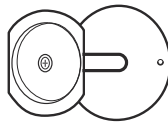

**PDF-161**  
Covers up to 2 1/8" hole  
under rim panic device

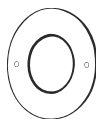

**CP-258**  
2 5/8" cylinder plate -  
indents at 3 & 9 o'clock  
prevents collar from  
shifting on wood or metal

NUMBER	DIMENSIONS	MATERIAL
AR-335	3 1/2" Diameter	Aluminum
AR-9K	3 1/2" Diameter	Aluminum
BF-135	3 3/4" Diameter	Steel
BF-161	2 5/8" Diameter	
BF-178	1 7/8" Diameter	
CP-258	2 5/8" Diameter	
PDF-161	2 1/8" Hole	

**SHELF PACK: 10** Polybagged  
**FEATURES:** •(CP-258): Can be used with Rim or Mortise  
 Cylinders  
 •(AR-335): Use with Schlage, Yale, Arrow,  
 Corbin-Russwin, Cal-Royal, Hager  
 •(AR-9K): Use with Sargent, Best, Marks  
**FINISHES:** (AR-335, AR-9K) 605, 613, 630  
 (BF-135, BF-161, BF-178, CP-258)  
**BP (Brass Plated), CP (Chrome Plated),**  
**PC (Prime Coated), SL (Silver Coated),**  
 (PDF-161) **PC (Prime Coated)**

**LATCH SPACER PLATE**



**LSP-1**

NUMBER	DIMENSIONS	MATERIAL
LSP-1	2 1/4" x 1 1/8"	Steel

**SHELF PACK:** 50 Polybagged  
**FEATURES:** Works with 1" latch face plates in a 1 1/8" prep  
**FINISHES:** Black - Plastic

**ELECTRIC STRIKE FILLER** plates for selected Folger Adams, Von Duprin, and Rofu numbers



**AF-260**

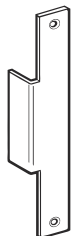

**AF-29**



**AF-29L**



**MAF-261**



**AF-261**



**AF-291**



**AF-291L**



**SMAF-261**

NUMBER	DIMENSIONS	MATERIAL
AF-29	9" x 1 3/8"	Steel
AF-29L	9" x 1 3/8"	
AF-260	4 7/8" x 1 1/4"	
AF-261	4 7/8" x 1 1/4"	
AF-291	9" x 1 3/8"	
AF-291L	9" x 1 3/8"	
MAF-261	4 7/8" x 1 1/4"	
SMAF-261	4 7/8" x 1 1/4"	

**SHELF PACK:** 10 Polybagged  
**GAUGE:** 13 (.095) Steel  
**FEATURES:** • Electric Strike Filler  
 • Fits selected Folger Adams, Von Duprin, and Rofu numbers  
 • (MAF-261, SMAF-261): Works with Schlage Mortise Locks and all other Mortise Locks  
**FINISHES:** DU (Duro Coated), SL (Silver Coated)

**FILLER PLATE KITS**

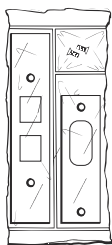

**FBRK-2**  
Flush bolt reinforcement kit

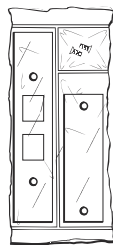

**FBRK-3**  
Blank Flush Bolt reinforcement kit

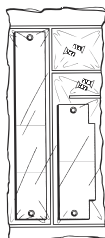

**FPK-86**  
For 86 cut out



**FPK-161**  
For 161 cut out

NUMBER	CONTENTS	MATERIAL
FBRK-2	Strike/Reinforcement	Steel
FBRK-3	Blank/Reinforcement	
FPK-86	EF-86/FS-260	
FPK-161	BF-161/EF-161 FS-260	

**SHELF PACK:** 10 Polybagged  
**FINISHES:** PC (Prime Coated)





**HINGE REINFORCEMENTS**

NUMBER	DESCRIPTION	USED WITH	SIZE	OFFSET	HINGE WEIGHT	GAUGE	MATERIAL
HR-100	3 1/2" Hinge Reinforcement	Door/Frame	1 1/16" x 8 1/2"	1/16"	.120	10	Steel
HR-110	4" Hinge Reinforcement	Door/Frame	1 1/4" x 10"	3/32"	.124	7	
HR-120	4 1/2" Hinge Reinforcement	Door/Frame	1 1/4" x 10"	3/32"	.134	7	
HR-130	4 1/2" Hinge Reinforcement	Frames	1 1/2" x 10"	3/32"	.134	7	
HR-140	4 1/2" Hinge Reinforcement	Door/Frame	1 1/4" x 10"	1/8"	.190	7	
HR-150	4 1/2" Hinge Reinforcement	Frames	1 1/2" x 10"	1/8"	.190	7	
HR-160	5" Hinge Reinforcement	Door/Frame	1 1/4" x 10"	3/32"	.146	7	
HR-170	5" Hinge Reinforcement	Frames	1 1/2" x 10"	3/32"	.146	7	
HR-180	5" Hinge Reinforcement	Door/Frame	1 1/4" x 10"	1/8"	.190	7	
HR-190	5" Hinge Reinforcement	Frames	1 1/2" x 10"	1/8"	.190	7	
HR-200-4 1/2	4 1/2" Blank Hinge Reinforcement	Door/Frame	1 1/4" x 10"	3/32"	-	7	
HR-210-5	5" Blank Hinge Reinforcement	Door/Frame	1 1/4" x 10"	3/32"	-	7	
HR-215-4 1/2	4 1/2" Flat Hinge Reinforcement	Doors	1 1/4" x 10"	-	-	7	
HR-216-5	5" Flat Hinge Reinforcement	Doors	1 1/4" x 10"	-	-	7	
HR-217	6" Hinge Reinforcement	Door/Frame	1 1/4" x 12"	7/64"	.160	7	
HR-218	6" Hinge Reinforcement	Door/Frame	1 1/4" x 12"	9/64"	.203	7	

**SHELF PACK: 25**  
**FINISH: Raw Steel**

**Box Pack**

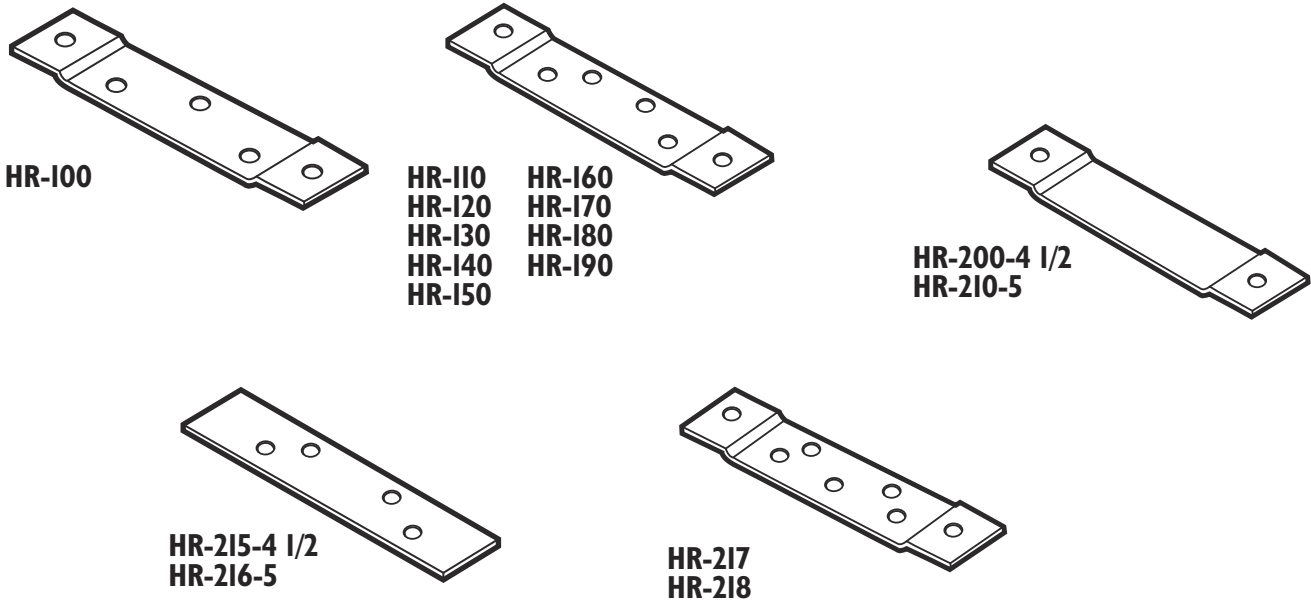

HINGE REINFORCEMENTS

DCB-270

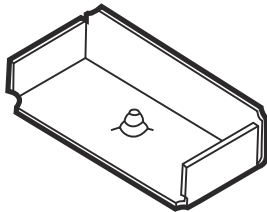
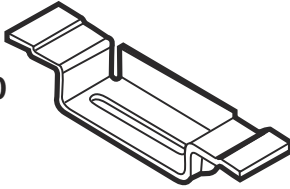

DCB-280

NUMBER	DESCRIPTION	DEPTH	GAUGE	MATERIAL
DCB-270	Dust Cover Box/Frame Hinge	3/4"	25	Steel
DCB-280	Dust Cover Box/Frame Hinge	5/16"	25	

SHELF PACK: 50  
FINISH: Raw Steel

Box Pack

STRIKE REINFORCEMENTS

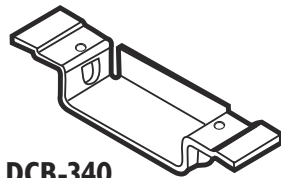

DCB-340

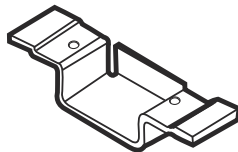

DCB-350

NUMBER	DESCRIPTION	MATERIAL
DCB-340	4 7/8" Strike w/Dust Cover	Steel
DCB-350	2 3/4" Strike w/Dust Cover	

SHELF PACK: 50  
FINISH: Raw Steel

Box Pack

STRAP ANCHORS

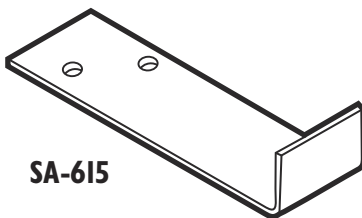

SA-615

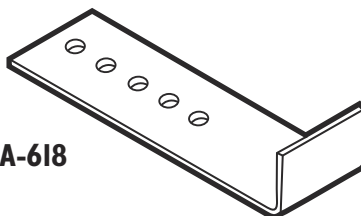

SA-618

NUMBER	DESCRIPTION	SIZE	GAUGE	MATERIAL
SA-615	Strap Anchor	1" x 4 1/2" x 1 1/4" W	16	Steel
SA-618	Strap Anchor	1" x 5" x 1" W	18	

SHELF PACK: 50  
FINISH: Raw Steel

Box Pack

TABS & GUIDES

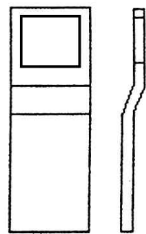
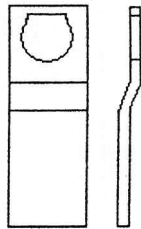
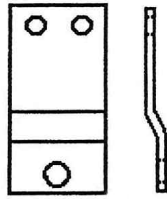
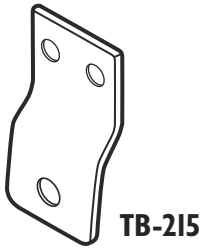

NUMBER	DIMENSIONS		OFFSET	MATERIAL
	LENGTH	WIDTH		
TB-215	1"	1 1/2"	1/8"	Steel
FBT-I	2 1/2"	7/8"	1/8"	
FBG-I-D	2 1/2"	7/8"	5/16"	
FBG-I-SQ	3 1/4"	1 3/4"	5/16"	

SHELF PACK: 50  
FINISH: Raw Steel

Box Pack

GLAZING BEAD

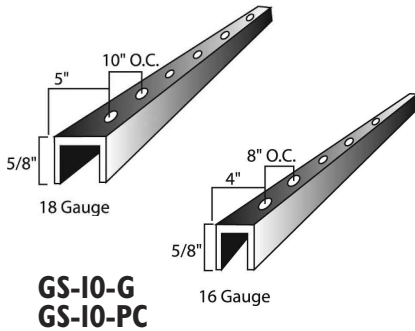

NUMBER	SIZE	GAUGE	MATERIAL
GS-10-G	5/8" x 5/8" x 5/8"	18	Galvanized
GS-10-PC	5/8" x 5/8" x 5/8"	16	Steel

SHELF PACK: 50

PIPE SLEEVE ANCHORS

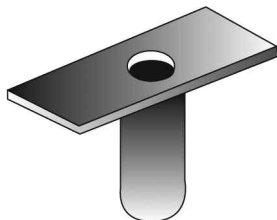

NUMBER	SIZES	GAUGE	MATERIAL
PSA	4 3/4", 5 3/4", 6 3/4", 7 3/4", 8 1/4", 8 3/4"	11	Steel

SHELF PACK: 50

Box Pack

**HOW TO ORDER:**  
Part # x Size, i.e.: PSA-5 3/4



**SPREADER BARS**

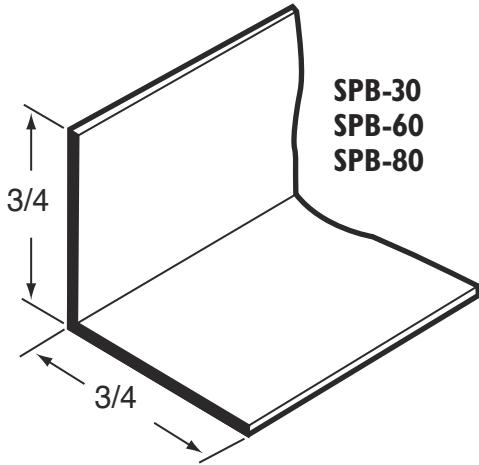

NUMBER	SIZE	LENGTH	GAUGE	MATERIAL
SPB-30	3/4" x 3/4"	36"	16	Steel
SPB-60	3/4" x 3/4"	72"	16	
SPB-80	3/4" x 3/4"	96"	16	
CSPB-30	3/4" x 3/4" x 3/4"	36"	16	
CSPB-50	3/4" x 3/4" x 3/4"	60"	16	
CSPB-80	3/4" x 3/4" x 3/4"	96"	16	

**SHELF PACK: 50**  
**FINISH: Raw Steel**

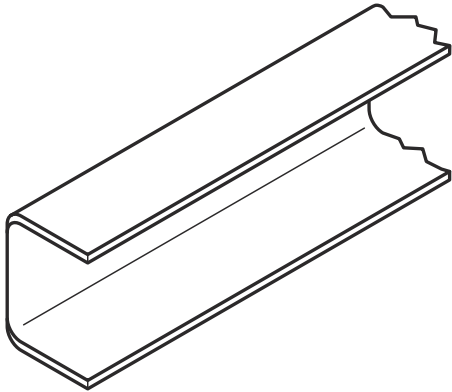

**METAL-WOOD STUD COMBO ANCHOR**

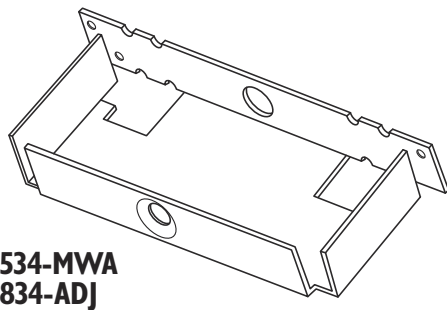

NUMBER	DESCRIPTION	MATERIAL
534-MWA	5 3/4"	Steel
834-ADJ	Adjust 5 3/4" to 8 3/4"	
MWAP	Anchor Plug	
MWA-I	Wire Anchor	

**SHELF PACK:** (534-MWA, 834-ADJ): 50 **Box Pack**  
(MWAP): 100 **Box Pack**  
(MWA-I): 520 **Box Pack**

**FEATURES:** (MWAP): Designed to fill the holes created when using 534-MWA

**FINISH:** Raw Steel  
(MWAP): Black



REINFORCEMENT PLATES

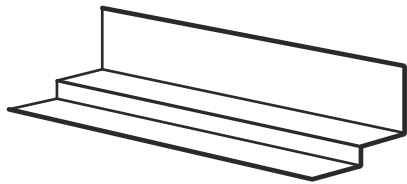

**CR-275**  
Closer  
Reinforcement

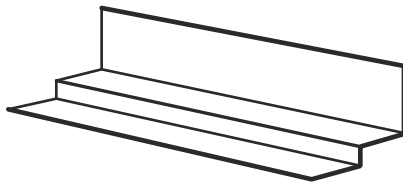
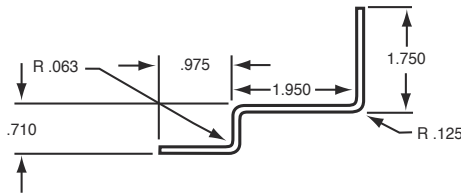

**CR-300**  
For use with  
Parallel arm  
closers

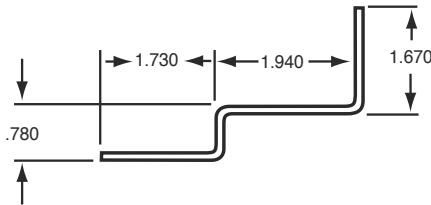

NUMBER	DIMENSIONS	GAUGE	MATERIAL
CR-060	12" x 1 3/4"	16	Steel
CR-125	12" x 1 3/4"	10	
CR-275	14" x 4 1/8"	12	
CR-300	14" x 4 1/8"	12	

SHELF PACK: 10  
FINISH: Raw Steel



**CR-060**  
16 (.060) Gauge  
Closer Reinforcement



**CR-125**  
10 (.125) Gauge  
Closer Reinforcement

TEMPORARY LOCKS

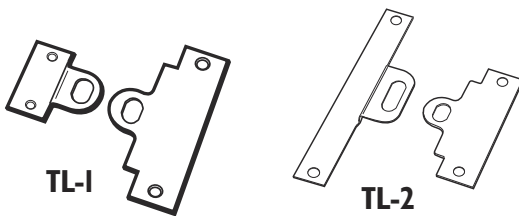

TL-1

TL-2

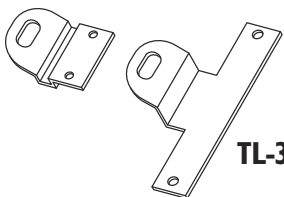

TL-3

NUMBER	DIMENSIONS		MATERIAL
	STRIKE	LATCH	
TL-1	4 7/8" x 1 1/4"	2 1/4" x 1 1/8"	Steel
TL-2	4 7/8" x 1 1/4"	8" x 1 1/4"	
TL-3	4 7/8" x 1 1/4"	2 1/4" x 1 1/8"	

SHELF PACK: 10 Polybagged  
 FEATURES: • (TL-1) Fits 2 1/4" latch preps and fits 4 7/8" strike prep  
 • (TL-2) Fits 86 edge preps and fits 4 7/8" strike prep  
 • (TL-3) Works with in swing doors  
 FINISH: Prime Coated

**TITLE 24 SIGNS**



**CHS-1  
CHS-6**



**CHS-2  
CHS-7**



**CHS-3  
CHS-8**



**CHS-4**



**CHS-5**



**HS-9070-46**



**HS-9070-47**



**HS-9070-48**

Sign Size 1 3/4" x 6"

NUMBER	DESCRIPTION	COLOR
CHS-1	Men	Blue
CHS-2	Women	Blue
CHS-3	Restroom	Blue
CHS-4	Boys	Blue
CHS-5	Girls	Blue
CHS-6	Men	Black
CHS-7	Women	Black
CHS-8	Restroom	Black
HS-9070-46	Men	Blue
HS-9070-47	Women	Blue
HS-9070-48	Restroom	Blue

**SHELF PACK: 10** Polybagged  
**FEATURES:** • Raised white lettering  
 • Braille translation on sign

**DECALS**



**HD-1**

NUMBER	DECAL COLOR	DIMENSIONS
DD-1/DD-5	Black on Clear	1 1/2" x 24"
DD-2/DD-6	White on Black	1 1/2" x 24"
DD-3/DD-7	Black on Clear	1 1/2" x 24"
DD-4/DD-8	White on Black	1 1/2" x 24"
HD-1	White on Blue	4" x 4"

Polybagged

**DD-1/DD-2 THIS DOOR TO REMAIN UNLOCKED DURING BUSINESS HOURS**

**DD-3/DD-4 THESE DOORS TO REMAIN UNLOCKED DURING BUSINESS HOURS**

**DD-5/DD-6 THIS DOOR TO REMAIN UNLOCKED WHILE BUILDING IS OCCUPIED**

**DD-7/DD-8 THESE DOORS TO REMAIN UNLOCKED WHILE BUILDING IS OCCUPIED**



A.D.A. SIGNS



**HS-9050-01**  
**HS-9060-01**  
**HS-9070-01**  
**HS-9090-01**



**HS-9060-02**  
**HS-9070-02**



**HS-9060-03**  
**HS-9070-03**



**HS-9070-07**

**BROWN SIGNS**

NUMBER	DESCRIPTION
HS-9060-01	Men's/Handicap
HS-9060-02	Men's Room
HS-9060-03	Restrooms
HS-9060-04	Women's Room
HS-9060-05	Women's/Handicap
HS-9060-22	No Smoking
HS-9060-32	Women/Men/Handicap
HS-9060-35	Exit
HS-9060-36	Arrow Diagonal
HS-9080-02	Handicap Accessible

(6"x6")  
(6"x6")



**HS-9060-04**  
**HS-9070-04**



**HS-9050-05**  
**HS-9060-05**  
**HS-9070-05**  
**HS-9090-05**



**HS-9060-22**  
**HS-9070-22**



**HS-9070-08**

**BLUE SIGNS**

NUMBER	DESCRIPTION
HS-9070-01	Men's/Handicap
HS-9070-02	Men's room
HS-9070-03	Restrooms
HS-9070-04	Women's Room
HS-9070-05	Women's/Handicap
HS-9070-06	Handicap Accessible
HS-9070-07	Boy's/Handicap
HS-9070-08	Girl's/Handicap
HS-9070-22	No Smoking
HS-9070-24	Stairs
HS-9070-27	Telephone
HS-9070-32	Women/Men/Handicap
HS-9070-34	Exit Route
HS-9070-35	Exit

(6"x6")  
(6"x6")



**HS-9070-24**



**HS-9070-27**



**HS-9050-32**  
**HS-9060-32**  
**HS-9070-32**  
**HS-9090-32**



**HS-9080-02**  
**HS-9070-06**

**TAN SIGNS**

NUMBER	DESCRIPTION
HS-9050-01	Men's/Handicap
HS-9050-05	Women's/Handicap
HS-9050-32	Women/Men/Handicap



**HS-9060-35**  
**HS-9070-35**



**HS-9060-36**



**HS-9070-34**

**BLACK SIGNS**

NUMBER	DESCRIPTION
HS-9090-01	Men's/Handicap
HS-9090-05	Women's/Handicap
HS-9090-32	Women/Men/Handicap

SHELF PACK: 10

Polybagged

FEATURES:

- Sign Size - 6" x 9"
- Raised white lettering
- Braille translation on sign
- A.D.A. compliant