

**STANDARD METAL**  
H A R D W A R E

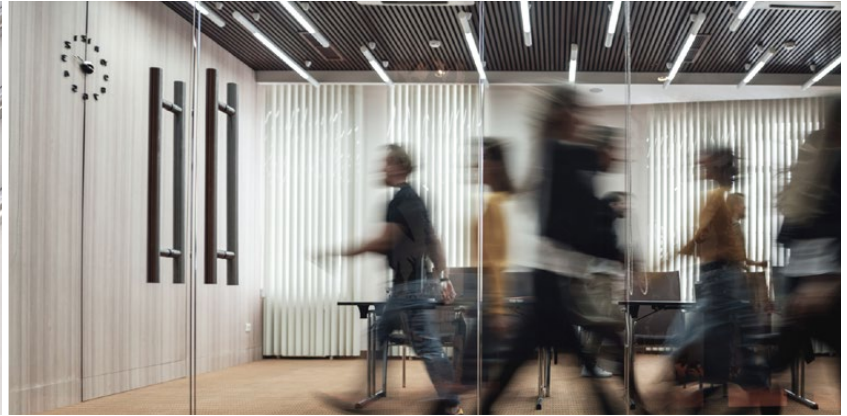

# CATALOGUE

SMHARDWARE.COM | SALES@SMHARDWARE.COM

We manufacture custom architectural door hardware solutions by combining modern designs with premium quality materials for a lasting first impression.

---





# SETTING THE STANDARD

---

## Over 30 Years of Manufacturing Innovation and Custom Design

Standard Metal Hardware Manufacturing Ltd. is a leading manufacturer of commercial and custom architectural door hardware in North America. Since 1989, we have been manufacturing from our facility in Toronto, Canada, committed to setting the standard for innovation and design.

We work closely with architects and designers around the world to create some of the most intricate and visually appealing custom architectural door hardware products using a variety of materials, styles and finishes. We supply a network of distributors across North America with an extensive product line including door pulls, grab bars, kick plates, door guards, door stops, patch locks, bolts, latches and more.

Our custom manufacturing is done in-house and is our way of controlling our production to guarantee that the products meet the highest level of quality and craftsmanship. Our products have been used on thousands of recognized building projects including hotels, airports, hospitals, schools, retail, office and other institutional buildings.

It is our vision to deliver door hardware solutions that enhance the appearance, security and value of every building project. Share your vision with us and we will help you bring it to life.





# CONTENTS

CUSTOM DESIGN .....	8
FANTOM .....	10
ANTIMICROBIAL .....	12
FIRERATED .....	14
FINISHES CHART .....	16
GENERAL INFO/MOUNTING .....	18
MOUNTING POST OPTIONS .....	19

## PRODUCTS

DOOR PULLS & PUSH BARS .....	21
------------------------------	----

### DOOR PULLS

STANDARD DOOR PULLS .....	22
STANDARD OFFSET DOOR PULLS .....	26
STANDARD HALF-ROUND DOOR PULLS .....	30
COMMERCIAL DOOR PULLS .....	34
INSTITUTIONAL PULLS .....	36

### PUSH BARS

STANDARD PUSH BARS .....	39
COMMERCIAL PUSH BARS .....	43

ARCHITECTURAL DOOR PULLS .....	51
--------------------------------	----

MODERN STRAIGHT .....	52
MODERN CURVES .....	57
MODERN ANGLES .....	62
MODERN FLAT .....	67
MODERN RECTANGULAR .....	73
MODERN SQUARE .....	76
WOOD .....	78
LEATHER .....	86
RUBBER .....	89
SPLIT FINISH .....	92
REEDED .....	94
GROOVES .....	95
HEX .....	98
CIRCULAR .....	100
TRADITIONAL .....	104
CLASSIC .....	108
INSPIRED DESIGN .....	112

<b>LOCKING DOOR PULLS</b> .....	<b>119</b>	<b>DOOR STOPS</b> .....	<b>191</b>
		FLOOR STOPS .....	<b>192</b>
<b>PATCH LOCK FITTINGS</b> .....	<b>125</b>	WALL STOPS .....	<b>199</b>
STANDARD MORTISE .....	<b>126</b>	BASEBOARD STOPS .....	<b>202</b>
DIGITAL ACCESS .....	<b>128</b>	DOOR HOLDERS .....	<b>203</b>
ELECTRIC STRIKE .....	<b>130</b>		
CUSTOM .....	<b>133</b>	<b>FANTOM HARDWARE</b> .....	<b>205</b>
		FANTOM DOOR STOP .....	<b>206</b>
<b>FLUSH PULLS &amp; PULL PLATES</b> .....	<b>135</b>	FANTOM FIRE DOOR STOP .....	<b>207</b>
RING PULLS .....	<b>136</b>		
FLUSH PULLS .....	<b>137</b>	<b>DOOR ACCESSORIES</b> .....	<b>209</b>
CYLINDER PULLS.....	<b>141</b>	FLUSH BOLTS .....	<b>210</b>
PULL PLATES .....	<b>143</b>	DOOR COORDINATORS .....	<b>219</b>
EDGE PULLS .....	<b>146</b>	SURFACE BOLTS .....	<b>222</b>
FOOT PULLS .....	<b>147</b>	ROLLER LATCHES .....	<b>224</b>
		DOOR VIEWERS .....	<b>228</b>
<b>PROTECTION PLATES</b> .....	<b>149</b>	COAT HOOKS .....	<b>229</b>
KICK PLATES .....	<b>150</b>		
ANGLE PLATES .....	<b>152</b>	<b>HANDRAILS &amp; BRACKETS</b> .....	<b>237</b>
U-CHANNELS .....	<b>154</b>	HANDRAILS .....	<b>238</b>
PUSH PLATES.....	<b>156</b>	HANDRAIL BRACKETS .....	<b>240</b>
CAST PUSH PLATES.....	<b>159</b>		
		<b>STRIKES &amp; FILLER PLATES</b> .....	<b>243</b>
<b>GUARDS &amp; ASTRAGALS</b> .....	<b>163</b>	STRIKES .....	<b>244</b>
EDGE GUARDS .....	<b>164</b>	FILLER PLATES .....	<b>248</b>
CORNER GUARDS .....	<b>168</b>	FLOOR STRIKES .....	<b>251</b>
ASTRAGALS.....	<b>169</b>		
FRAME GUARDS.....	<b>172</b>	<b>CABINET PULLS AND KNOBS</b> .....	<b>253</b>
TRIM GUARDS.....	<b>174</b>		
		<b>CLOSET RODS &amp; FLANGES</b> .....	<b>257</b>
<b>GRAB BARS</b> .....	<b>179</b>		
Ø 1-1/4" - STRAIGHT GRAB BARS .....	<b>180</b>	<b>HANDS-FREE HARDWARE</b> .....	<b>261</b>
Ø 1-1/4" - ANGLED GRAB BARS .....	<b>181</b>	ARM PULLS .....	<b>262</b>
Ø 1-1/4" - LIFT UP GRAB BARS.....	<b>185</b>	FOOT PULLS .....	<b>264</b>
Ø 1-1/2" - STRAIGHT GRAB BARS.....	<b>186</b>		
Ø 1-1/2" - ANGLED GRAB BARS.....	<b>187</b>	<b>INDEX</b> .....	<b>266</b>



# CUSTOM DESIGNED H A R D W A R E

Our team of experts will work with you to design and manufacture custom hardware solutions to fit your exact specifications. Share your idea with us and we will help bring your vision to reality.

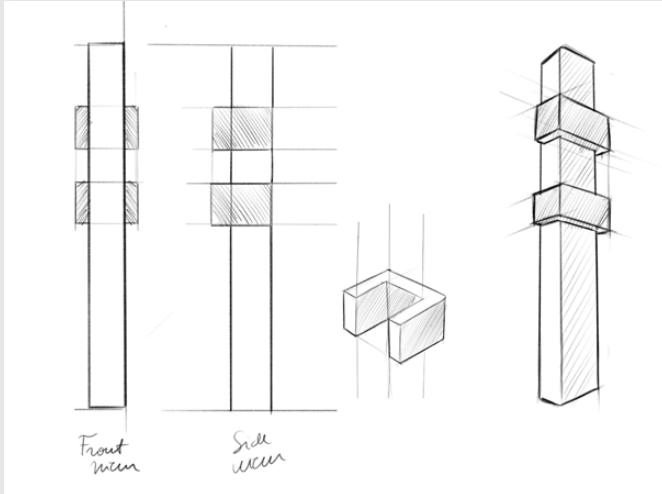

## IMAGINE

Create your product idea as a doodle, sketch, or technical drawing. Describe its primary purpose and main features including size, materials and finish.

## DESIGN

Collaborate with our team of experts to refine your idea and bring your vision to life using the latest technology and manufacturing techniques. Our team will create a 3D CAD model of the product for your approval.



## BUILD

Our custom manufacturing is done in-house and is our way of guaranteeing that the products we create meet the highest standard for quality and craftsmanship.



## APPLICATION IDEAS

- Designer Door Pulls
- Custom Door Plates
- Custom Patch Locks
- Custom Grab Bars
- Door and Frame Guards
- Laser Etching & Engraving

## FINISHES

- Mirror & Brushed
- Powder Coated
- Anodized
- Electroplated
- Antiqued

## MATERIALS

- Stainless Steel
- Aluminum
- Brass
- Copper
- Wood
- Leather

## OPTIONS

- Custom Bends
- Specialty Cut-Outs
- Ink-fill Engraving
- Laser Etching
- Custom Castings

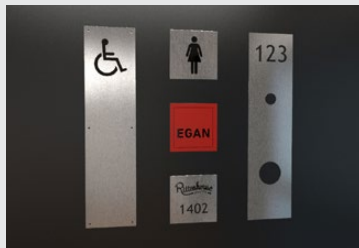



Official Canadian distributor of  
Fantom Hardware

**NO TRIP  
HAZARD.  
FULLY  
CONCEALED.  
HOLD-OPEN  
FEATURE.**





## DESCRIPTION

The Fantom Doorstop is a fully concealed magnetic doorstop that includes a hold-open function.

The Fantom Doorstop system provides a high quality innovative solution for all project application requirements, alleviating trip hazards whilst maintaining a modern desirable finish. The concealed rare-earth magnet technology ensures exceptional mechanical functionality.

There is a Fantom Doorstop for most doorstop applications, including:

- Internal hollow and solid doors (as shown)
- Sliding/Barn doors
- Pivot doors
- Aluminium and hollow extrusion doors (as shown)
- Fire doors
- Entrance/Security doors (see Defender)

## SKU'S

### FANTOM DOOR STOP

FINISH	SKU
SATIN	FANTOM-DS.SATIN
CHROME	FANTOM-DS.CHROME
BRASS	FANTOM-DS.BRASS
BLACK	FANTOM-DS.BLACK
WHITE	FANTOM-DS.WHITE
CLEAR	FANTOM-DS.CLEAR

### FANTOM FIRE DOOR STOP

FINISH	SKU
SATIN	FANTOM-F.SATIN
CHROME	FANTOM-F.CHROME
CLEAR	FANTOM-F.CLEAR



# **ANTIMICROBIAL** H A R D W A R E

Protect clients and staff from exposure to harmful microorganisms, bacteria and mold. Antimicrobial clear coating available on any door hardware product or design.



Harmful microorganisms reside on every surface we touch. Protecting high touch surfaces with an antimicrobial coating can interrupt cell multiplication and prevent the spread of infectious diseases. Independent laboratory results show a significant decrease in microbial population on treated surfaces. These coatings are safe, nontoxic and formulated to provide protection over an extended period of time. High traffic or public use areas are ideally suited for antimicrobial clear coated door hardware. Hardware options are available to fit any building use and design.

## **BENEFITS**

- Inhibits the growth of harmful microorganisms, bacteria and mold
- Protects against the spread of infectious diseases
- Retains antimicrobial properties under normal use conditions
- Suitable for healthcare, education, food service, restrooms, retail, office
- Environmentally friendly

## **FEATURES**

- Available on any door hardware product or design
- Applications include door pulls, push plates, hand rails, grab bars
- Superior chemical, stain and scratch resistance
- Can be formulated for exterior durability





MICROORGANISM	NUMBER OF LIVING BACTERIA	
	0 hrs (Start)	After 24 hrs
<b>Escherichia Coli</b>		
Conventional Coating	380,000	27,000,000
Antimicrobial Coating	380,000	<100
Antimicrobial Coating after 5 washings	380,000	<100
<b>Staphylococcus Aureus</b>		
Conventional Coating	380,000	1,100,000
Antimicrobial Coating	380,000	<100
Antimicrobial Coating after 5 washings	380,000	<100

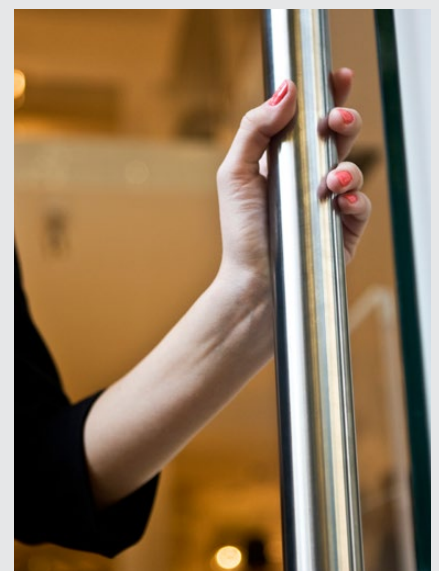
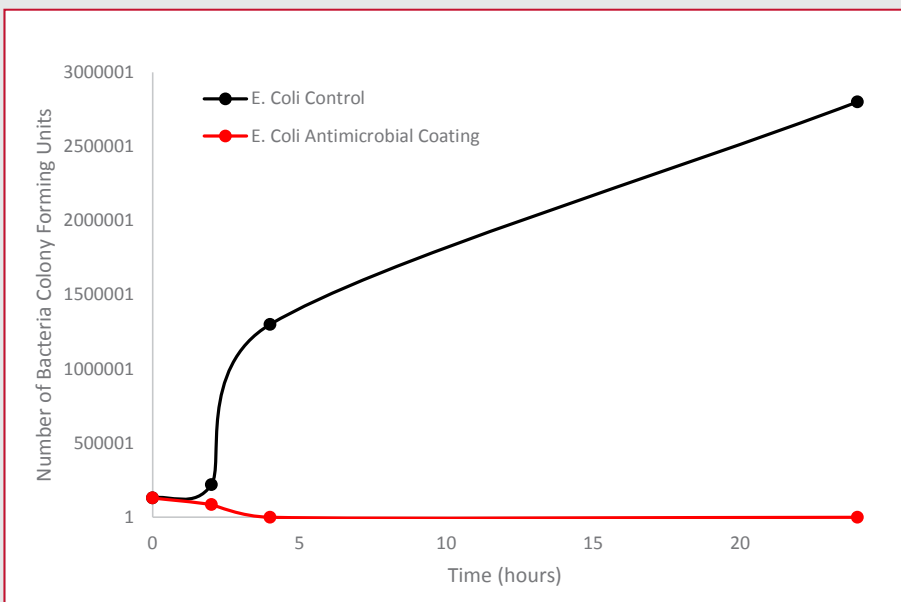
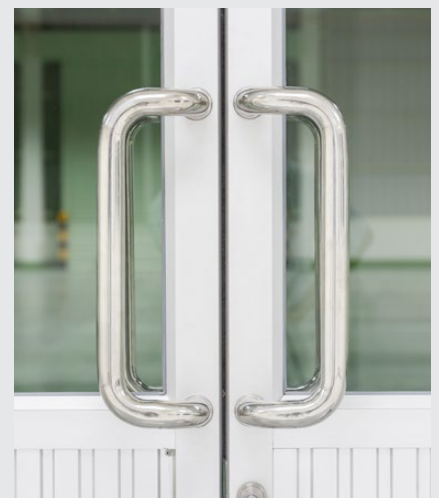

# FIRE RATED HARDWARE

A fire rated opening is part of a building's fire protection system that provides two distinct functions: reduce the spread of fire and enable safe egress from the building in the event of a fire.

For an opening to qualify as fire rated, the door, jamb and hardware must be listed with an agency that is in compliance with NFPA Standards, building codes and any local ordinances (with the exception of kick plates mounted below 16" from the bottom of door).



Fire rated door hardware includes flush bolts, surface bolts, astragals, hinges, lock/exit devices, door closers, door coordinators, glass lites and door viewers. In addition, any add-on components including protection plates, edge guards, frame guards must be listed if they are to be used on a fire rated opening.

## PRODUCTS OFFERED

SMH offers a variety of fire rated hardware for use with fire rated openings.

- Edge Guards
- Door Protection Plates
- Edge Guards
- Frame Guards
- Manual Flush Bolts
- Automatic and Self Latching Flush Bolts
- Door Coordinators
- Surface Bolts
- Door Viewers

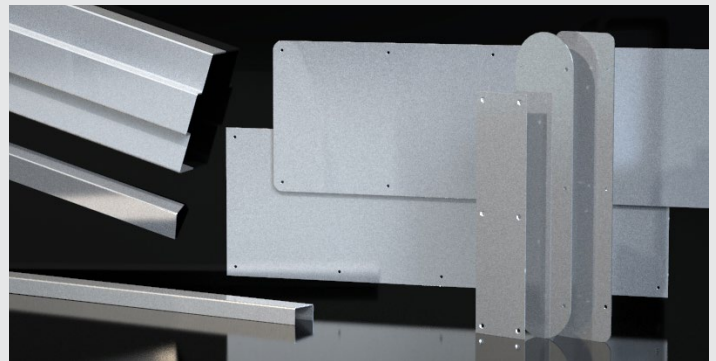



## ABOUT OUR CERTIFICATIONS

SMH Fire Rated Products are tested, evaluated and listed by Intertek (WH-ETL) and Underwriters Laboratory (UL).

The WH-ETL and UL Certification Mark is relied on by code enforcement officials and buyers as an assurance that products meet regulatory requirements. It is a key differentiator for products within the architectural door hardware market.

SMH Fire Rated Products are evaluated by Intertek and UL for compliance with the following standards: CAN4 S104 (1985), UL 10(b) (2008), NFPA 252 (2008), NFPA 252 (2012), CAN / ULC S104 (2015), UL 10(b) (R2015)







## ABOUT INTERTEK & UL

Intertek and UL are both independent testing organizations known as a Nationally Recognized Testing Laboratory (NRTL) and provide complete testing and certification services for a wide variety of products to verify that they meet certain safety requirements during use, or in the event of a fire or other circumstances.



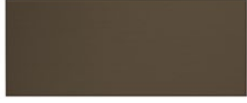

# FINISHES CHART









NBHA	BHMA	MATERIALS	FINISHES	
3	605	BR, BRZ, STL, SS, ZN	BRIGHT BRASS, CLEAR LACQUERED	
4	606	BR, BRZ, STL, SS, ZN	SATIN BRASS, CLEAR LACQUERED	
5	609	BR, BRZ, STL, SS, ZN	SATIN BRASS, OXIDIZED AND RELIEVED (ANTIQUED)	
9	611	BR, BRZ, STL, SS, ZN	BRIGHT BRONZE, CLEAR LACQUERED	
10	612	BR, BRZ, STL, SS, ZN	SATIN BRONZE, CLEAR LACQUERED	
10B	613	BR, BRZ, STL, SS, ZN	SATIN BRONZE, OXIDIZED AND OIL RUBBED	
10BE	613E	BR, BRZ, STL, SS, ZN	SATIN BRONZE, OXIDIZED AND OIL RUBBED EQUIVALENT	
14	618	BR, BRZ, STL, SS, ZN	BRIGHT NICKEL	
15	619	BR, BRZ, STL, SS, ZN	SATIN NICKEL	
19	671	BR, BRZ, AL, STL, SS, ZN	FLAT BLACK POWDER COATED	

**MATERIALS LEGEND:** Brass = BR | Bronze = BRZ | Aluminum = AL | Steel = STL | Stainless Steel = SS



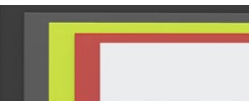

# FINISHES CHART

NBHA	BHMA	MATERIALS	FINISHES
20L	623	BR, BRZ, STL, SS, ZN	BRONZE, OXIDIZED LIGHT AND LACQUERED 
20D	624	BR, BRZ, STL, SS, ZN	BRONZE, OXIDIZED DARK AND LACQUERED 
26	625	BR, BRZ, STL, SS, ZN	BRIGHT CHROMIUM 
26D	626	BR, BRZ, STL, SS, ZN	SATIN CHROMIUM 
28	628	AL	SATIN ALUMINUM, ANODIZED CLEAR 
K29	711	AL	SATIN ALUMINUM, ANODIZED BLACK 
32	629	BR, BRZ, STL, SS, ZN	BRIGHT STAINLESS STEEL 
32D	630	BR, BRZ, STL, SS, ZN	SATIN STAINLESS STEEL 
34		BR, BRZ, AL, STL, SS, ZN	GRAPHITE NICKEL POWDER COAT 
P	600	BR, BRZ, AL, STL, SS, ZN	PRIMED FOR PAINT
PC		BR, BRZ, AL, STL, SS, ZN	POWDER COAT (STANDARD & CUSTOM COLOURS AVAILABLE) 

| Zinc = ZN



# MOUNTING OPTIONS

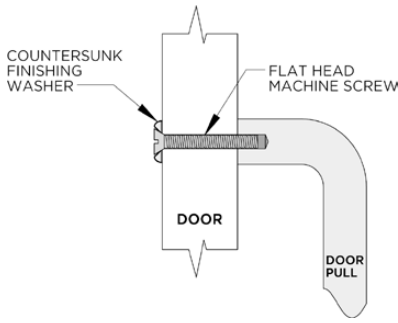

**#2** = STANDARD SINGLE THRU BOLT MOUNTING FOR WOOD AND METAL DOORS

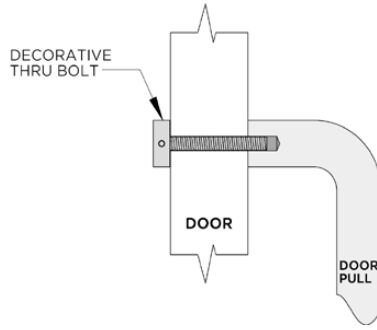

**#4** = SINGLE DECORATIVE MOUNTING FOR WOOD AND METAL DOORS

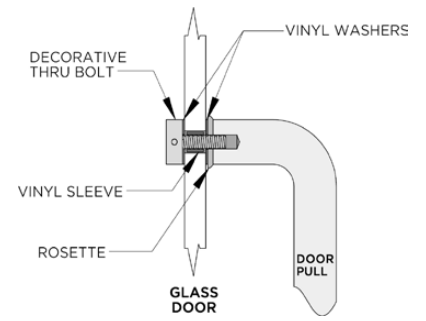

**#4G** = SINGLE DECORATIVE MOUNTING FOR GLASS DOORS

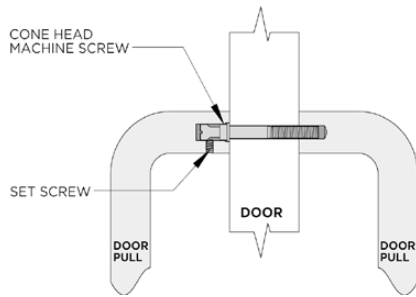

**#5** = BACK TO BACK MOUNTING FOR WOOD AND METAL DOORS

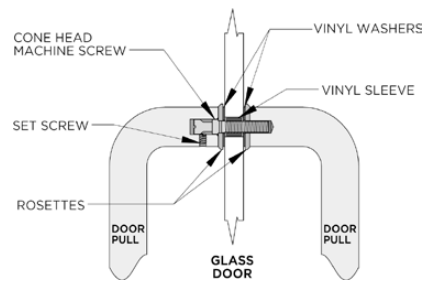

**#5G** = BACK TO BACK MOUNTING FOR GLASS DOORS

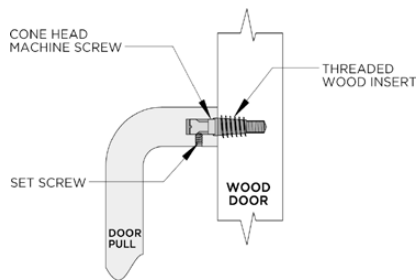

**#6W** = SINGLE CONCEALED MOUNTING FOR WOOD DOORS

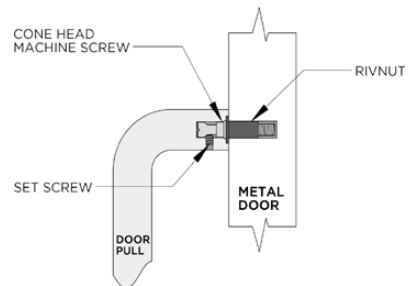

**#6M** = SINGLE CONCEALED MOUNTING FOR METAL DOORS

## DOOR HANDING

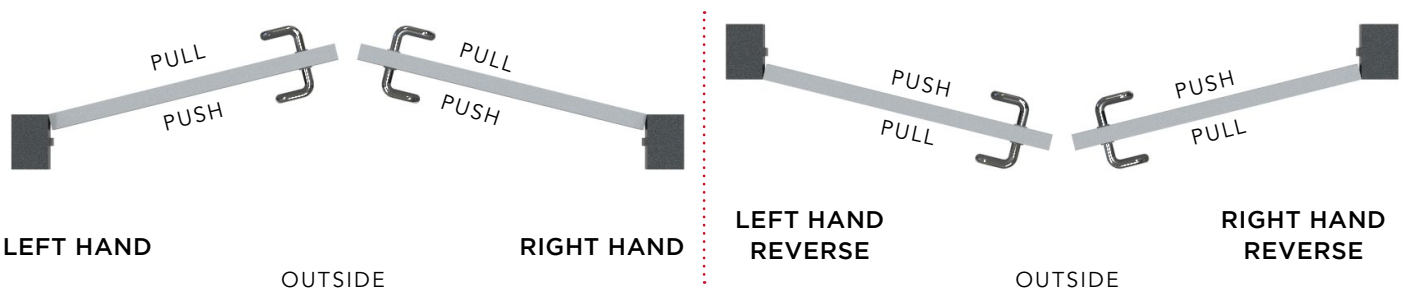

DOOR HANDING IS DETERMINED FROM OUTSIDE OF OPENING



# POST OPTIONS

DIFFERENT VARIATIONS OF MOUNTING POSTS ARE AVAILABLE

## STANDARD POSTS



**'A' POST**



**'B' POST**

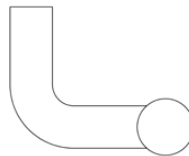

**'H' POST**

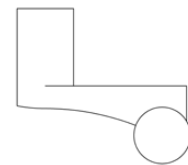

## CUSTOM POSTS



**'C' POST**



**'D' POST**



**'E' POST**



**'F' POST**

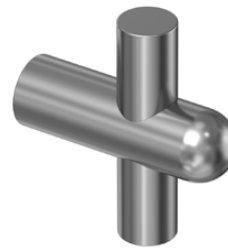

**'G' POST**



### HOW TO ORDER:

- EX. FOR PRODUCT D352 WITH "E POST" USE CODE D352E
- EX. FOR PRODUCT D500 WITH "H POST" USE CODE D500H



# DOOR PULLS & PUSH BARS

---



**22** STANDARD DOOR PULLS

**26** STANDARD OFFSET DOOR PULLS

**30** STANDARD HALF-ROUND DOOR PULLS

**34** COMMERCIAL DOOR PULLS

**36** INSTITUTIONAL PULLS

**39** STANDARD PUSH BARS

**43** COMMERCIAL PUSH BARS





# DOOR PULLS & PUSH BARS

## STANDARD DOOR PULLS

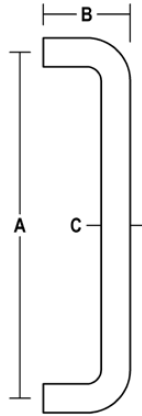

### 2000 STANDARD DOOR PULL

NO.	A	B	C
2007-1	7"	2.5"	Ø 0.75"
2007-2	7"	3"	Ø 1"
2007-3	7"	3.25"	Ø 1.25"
2009-1	9"	2.5"	Ø 0.75"
2009-2	9"	3"	Ø 1"
2009-3	9"	3.25"	Ø 1.25"
2012-1	12"	2.5"	Ø 0.75"
2012-2	12"	3"	Ø 1"
2012-3	12"	3.25"	Ø 1.25"
2015-1	15"	2.5"	Ø 0.75"
2015-2	15"	3"	Ø 1"
2015-3	15"	3.25"	Ø 1.25"

**FEATURED FINISHES:** Flat Black (19), Satin Stainless (32D), Antimicrobial (AM)

**FINISHES:** Standard & Custom Available (See Pages 16 & 17)

**MATERIALS:** Aluminum, Brass, Bronze, Stainless Steel

**PRODUCT OPTIONS:** Combination Push/Pull: Order with 6000 Series Push Bars



### 2100 STANDARD DOOR PULL W/ GLASS DOOR ROSETTES

NO.	A	B	C	D
2107-1	7"	2.5"	Ø 0.75"	Ø 1"
2107-2	7"	3"	Ø 1"	Ø 1.25"
2107-3	7"	3.25"	Ø 1.25"	Ø 1.5"
2109-1	9"	2.5"	Ø 0.75"	Ø 1"
2109-2	9"	3"	Ø 1"	Ø 1.25"
2109-3	9"	3.25"	Ø 1.25"	Ø 1.5"
2112-1	12"	2.5"	Ø 0.75"	Ø 1"
2112-2	12"	3"	Ø 1"	Ø 1.25"
2112-3	12"	3.25"	Ø 1.25"	Ø 1.5"
2115-1	15"	2.5"	Ø 0.75"	Ø 1"
2115-2	15"	3"	Ø 1"	Ø 1.25"
2115-3	15"	3.25"	Ø 1.25"	Ø 1.5"

**FEATURED FINISHES:** Flat Black (19), Satin Stainless (32D), Antimicrobial (AM)

**FINISHES:** Standard & Custom Available (See Pages 16 & 17)

**MATERIALS:** Aluminum, Brass, Bronze, Stainless Steel

**PRODUCT OPTIONS:** Combination Push/Pull: Order with 6000 Series Push Bars



# DOOR PULLS & PUSH BARS

## STANDARD DOOR PULLS

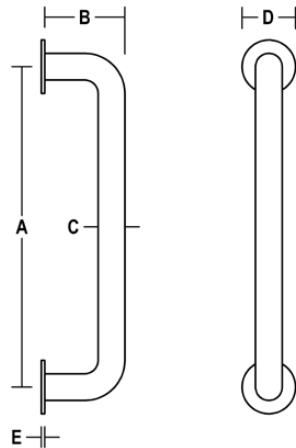

### 2200

#### STANDARD DOOR PULL W/ 2" ROSETTES

NO.	A	B	C	D	E
2207-1	7"	2.5"	Ø 0.75"	Ø 2"	0.125"
2207-2	7"	3"	Ø 1"	Ø 2"	0.125"
2207-3	7"	3.25"	Ø 1.25"	Ø 2"	0.125"
2209-1	9"	2.5"	Ø 0.75"	Ø 2"	0.125"
2209-2	9"	3"	Ø 1"	Ø 2"	0.125"
2209-3	9"	3.25"	Ø 1.25"	Ø 2"	0.125"
2212-1	12"	2.5"	Ø 0.75"	Ø 2"	0.125"
2212-2	12"	3"	Ø 1"	Ø 2"	0.125"
2212-3	12"	3.25"	Ø 1.25"	Ø 2"	0.125"
2215-1	15"	2.5"	Ø 0.75"	Ø 2"	0.125"
2215-2	15"	3"	Ø 1"	Ø 2"	0.125"
2215-3	15"	3.25"	Ø 1.25"	Ø 2"	0.125"

**FEATURED FINISHES:** Flat Black (19), Satin Stainless (32D), Antimicrobial (AM)

**FINISHES:** Standard & Custom Available (See Pages 16 & 17)

**MATERIALS:** Aluminum, Brass, Bronze, Stainless Steel

**PRODUCT OPTIONS:** Combination Push/Pull: Order with 6000 Series

Push Bars

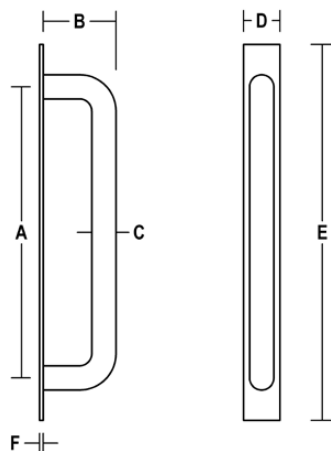

### 2300

#### STANDARD DOOR PULL W/ NARROW BACKPLATE

NO.	A	B	C	D	E	F
2307-1	7"	2.5"	Ø 0.75"	1.5"	10.5"	0.125"
2307-2	7"	3"	Ø 1"	1.5"	10.5"	0.125"
2307-3	7"	3.25"	Ø 1.25"	1.5"	10.5"	0.125"
2309-1	9"	2.5"	Ø 0.75"	1.5"	12.5"	0.125"
2309-2	9"	3"	Ø 1"	1.5"	12.5"	0.125"
2309-3	9"	3.25"	Ø 1.25"	1.5"	12.5"	0.125"
2312-1	12"	2.5"	Ø 0.75"	1.5"	15.5"	0.125"
2312-2	12"	3"	Ø 1"	1.5"	15.5"	0.125"
2312-3	12"	3.25"	Ø 1.25"	1.5"	15.5"	0.125"
2315-1	15"	2.5"	Ø 0.75"	1.5"	18.5"	0.125"
2315-2	15"	3"	Ø 1"	1.5"	18.5"	0.125"
2315-3	15"	3.25"	Ø 1.25"	1.5"	18.5"	0.125"

**FEATURED FINISHES:** Flat Black (19), Satin Stainless (32D), Antimicrobial (AM)

**FINISHES:** Standard & Custom Available (See Pages 16 & 17)

**MATERIALS:** Aluminum, Brass, Bronze, Stainless Steel



# DOOR PULLS & PUSH BARS

## STANDARD DOOR PULLS

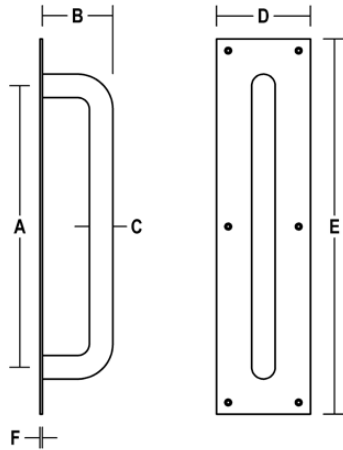

### 2400

#### STANDARD DOOR PULL W/ BACKPLATE

NO.	A	B	C	D	E	F
2407-1	7"	2.5"	Ø 0.75"	3.5"	15"	0.05"
2407-2	7"	3"	Ø 1"	3.5"	15"	0.05"
2407-3	7"	3.25"	Ø 1.25"	3.5"	15"	0.05"
2409-1	9"	2.5"	Ø 0.75"	3.5"	15"	0.05"
2409-2	9"	3"	Ø 1"	3.5"	15"	0.05"
2409-3	9"	3.25"	Ø 1.25"	3.5"	15"	0.05"
2412-1	12"	2.5"	Ø 0.75"	4"	16"	0.05"
2412-2	12"	3"	Ø 1"	4"	16"	0.05"
2412-3	12"	3.25"	Ø 1.25"	4"	16"	0.05"
2415-1	15"	2.5"	Ø 0.75"	4"	20"	0.05"
2415-2	15"	3"	Ø 1"	4"	20"	0.05"
2415-3	15"	3.25"	Ø 1.25"	4"	20"	0.05"

Backplate Thickness Code: **A** = 0.05", **B** = 0.06", **C** = 0.125"

**FEATURED FINISHES:** Flat Black (19), Satin Stainless (32D), Antimicrobial (AM)

**FINISHES:** Standard & Custom Available (See Pages 16 & 17)

**MATERIALS:** Aluminum, Brass, Bronze, Stainless Steel

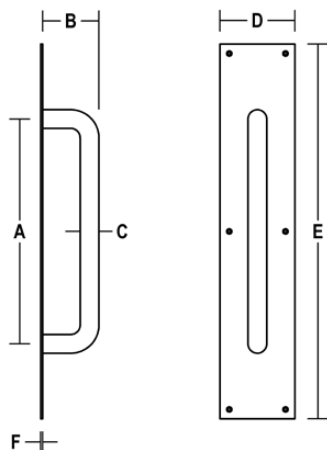

### 2500

#### STANDARD DOOR PULL W/ LARGE BACKPLATE

NO.	A	B	C	D	E	F
2507-1	7"	2.5"	Ø 0.75"	4"	16"	0.05"
2507-2	7"	3"	Ø 1"	4"	16"	0.05"
2507-3	7"	3.25"	Ø 1.25"	4"	16"	0.05"
2509-1	9"	2.5"	Ø 0.75"	4"	16"	0.05"
2509-2	9"	3"	Ø 1"	4"	16"	0.05"
2509-3	9"	3.25"	Ø 1.25"	4"	16"	0.05"
2512-1	12"	2.5"	Ø 0.75"	4"	20"	0.05"
2512-2	12"	3"	Ø 1"	4"	20"	0.05"
2512-3	12"	3.25"	Ø 1.25"	4"	20"	0.05"
2515-1	15"	2.5"	Ø 0.75"	5"	20"	0.05"
2515-2	15"	3"	Ø 1"	5"	20"	0.05"
2515-3	15"	3.25"	Ø 1.25"	5"	20"	0.05"

Backplate Thickness Code: **A** = 0.05", **B** = 0.06", **C** = 0.125"

**FEATURED FINISHES:** Flat Black (19), Satin Stainless (32D), Antimicrobial (AM)

**FINISHES:** Standard & Custom Available (See Pages 16 & 17)

**MATERIALS:** Aluminum, Brass, Bronze, Stainless Steel





# DOOR PULLS & PUSH BARS

## STANDARD DOOR PULLS

## HOW TO ORDER

### 1. SELECT PRODUCT

#### 1. CONFIRM “CENTRE-TO-CENTRE”

LAST TWO DIGITS REPRESENT THE C/C OF PULL

EXAMPLE: 2009

REPRESENTS: [2000 PULL x 9” C/C]

#### 2. CONFIRM “DIAMETER”

DIAMETER CODES:

- **-1** = 0.75”
- **-2** = 1”
- **-3** = 1.25”

EXAMPLE: 2009-2

REPRESENTS: [2000 PULL x 9” C/C] x **1” DIAMETER**

### 2. SPECIFY MOUNTING (SEE PAGE 18)

CHOOSE FROM:

- #2 = STANDARD SINGLE THRU BOLT MTG
- #4 = SINGLE DECORATIVE MTG
- #4G = SINGLE DECORATIVE GLASS MTG
- #5 = BACK TO BACK MTG
- #5G = BACK TO BACK GLASS MTG
- #6W = SINGLE CONCEALED WOOD MTG
- #6M = SINGLE CONCEALED METAL MTG

EXAMPLE: 2009-2 x #2

REPRESENTS: [2000 PULL x 9” C/C x 1” DIAMETER] x **STANDARD SINGLE THRU BOLT MTG**

### 3. SPECIFY FINISH

**A.** SEE PAGE 16-17 FOR A LIST OF ALL AVAILABLE FINISHES

**B.** CHOOSE FROM FINISHES THAT LIST BASE MATERIALS THAT ARE AVAILABLE FOR YOUR PRODUCT (EACH PRODUCT LISTS AVAILABLE MATERIALS)

**C.** ADD THE “NBHA” OR “BHMA” CODE TO YOUR ORDER

EXAMPLE: 2009-2 x #2 x **C32D**

REPRESENTS: [2000 PULL x 9” C/C x 1” DIAMETER x STANDARD SINGLE THRU BOLT MTG]  
x **SATIN STAINLESS STEEL**

### PUSH/PULL COMBINATION (OPTIONAL): PAIR WITH 6000 PUSH BAR

EXAMPLE: 2012-2 x 6034-2

REPRESENTS: COMBINATION (2000 PULL x 12” C/C x 1” DIAM) x (6000 PUSH BAR x 34” C/C x 1” DIAM)



# DOOR PULLS & PUSH BARS

## STANDARD OFFSET DOOR PULLS

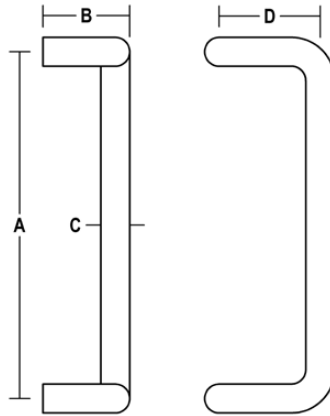

### 3000 STANDARD OFFSET DOOR PULL

NO.	A	B	C	D
3009-1	9"	2.5"	Ø 0.75"	3"
3009-2	9"	3"	Ø 1"	3.5"
3009-3	9"	3.25"	Ø 1.25"	4"
3012-1	12"	2.5"	Ø 0.75"	3"
3012-2	12"	3"	Ø 1"	3.5"
3012-3	12"	3.25"	Ø 1.25"	4"
3015-1	15"	2.5"	Ø 0.75"	3"
3015-2	15"	3"	Ø 1"	3.5"
3015-3	15"	3.25"	Ø 1.25"	4"

Combination Push/Pull:  
Order with 6000 Series Push Bars

**FEATURED FINISHES:** Flat Black (19), Satin Stainless (32D),  
Antimicrobial (AM)

**FINISHES:** Standard & Custom Available (See Pages 14 & 15)

**MATERIALS:** Aluminum, Brass, Bronze, Stainless Steel

**PRODUCT OPTIONS:** Combination Push/Pull: Order with  
6000 Series Push Bars

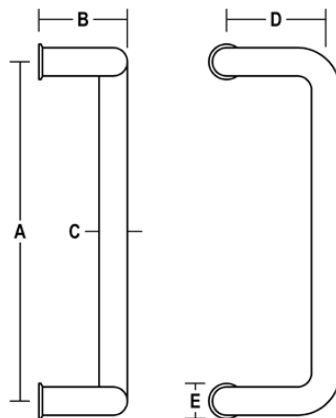

### 3100 STANDARD OFFSET DOOR PULL W/ GLASS DOOR ROSETTES

NO.	A	B	C	D	E
3109-1	9"	2.5"	Ø 0.75"	3"	Ø 1"
3109-2	9"	3"	Ø 1"	3.5"	Ø 1.25"
3109-3	9"	3.25"	Ø 1.25"	4"	Ø 1.5"
3112-1	12"	2.5"	Ø 0.75"	3"	Ø 1"
3112-2	12"	3"	Ø 1"	3.5"	Ø 1.25"
3112-3	12"	3.25"	Ø 1.25"	4"	Ø 1.5"
3115-1	15"	2.5"	Ø 0.75"	3"	Ø 1"
3115-2	15"	3"	Ø 1"	3.5"	Ø 1.25"
3115-3	15"	3.25"	Ø 1.25"	4"	Ø 1.5"

Combination Push/Pull:  
Order with 6000 Series Push Bars

**FEATURED FINISHES:** Flat Black (19), Satin Stainless (32D),  
Antimicrobial (AM)

**FINISHES:** Standard & Custom Available (See Pages 16 & 17)

**MATERIALS:** Aluminum, Brass, Bronze, Stainless Steel

**PRODUCT OPTIONS:** Combination Push/Pull: Order with  
6000 Series Push Bars



# DOOR PULLS & PUSH BARS

## STANDARD OFFSET DOOR PULLS

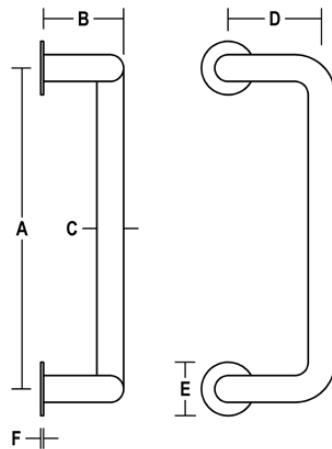

### 3200

#### STANDARD OFFSET DOOR PULL W/ 2" ROSETTES

NO.	A	B	C	D	E	F
3209-1	9"	2.5"	Ø 0.75"	3"	Ø 2"	0.125"
3209-2	9"	3"	Ø 1"	3.5"	Ø 2"	0.125"
3209-3	9"	3.25"	Ø 1.25"	4"	Ø 2"	0.125"
3212-1	12"	2.5"	Ø 0.75"	3"	Ø 2"	0.125"
3212-2	12"	3"	Ø 1"	3.5"	Ø 2"	0.125"
3212-3	12"	3.25"	Ø 1.25"	4"	Ø 2"	0.125"
3215-1	15"	2.5"	Ø 0.75"	3"	Ø 2"	0.125"
3215-2	15"	3"	Ø 1"	3.5"	Ø 2"	0.125"
3215-3	15"	3.25"	Ø 1.25"	4"	Ø 2"	0.125"

Combination Push/Pull:  
Order with 6000 Series Push Bars

**FEATURED FINISHES:** Flat Black (19), Satin Stainless (32D), Antimicrobial (AM)

**FINISHES:** Standard & Custom Available (See Pages 16 & 17)

**MATERIALS:** Aluminum, Brass, Bronze, Stainless Steel

**PRODUCT OPTIONS:** Combination Push/Pull: Order with 6000 Series Push Bars

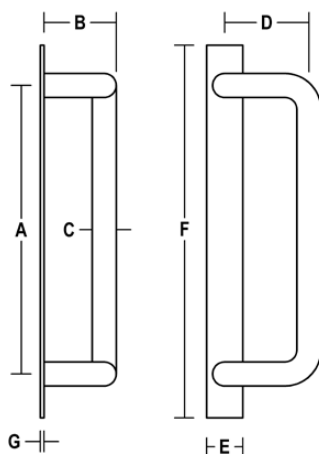

### 3300

#### STANDARD OFFSET DOOR PULL W/ NARROW BACKPLATE

NO.	A	B	C	D	E	F	G
3309-1	9"	2.5"	Ø 0.75"	3"	1.5"	12.5"	0.125"
3309-2	9"	3"	Ø 1"	3.5"	1.5"	12.5"	0.125"
3309-3	9"	3.25"	Ø 1.25"	4"	1.5"	12.5"	0.125"
3312-1	12"	2.5"	Ø 0.75"	3"	1.5"	15.5"	0.125"
3312-2	12"	3"	Ø 1"	3.5"	1.5"	15.5"	0.125"
3312-3	12"	3.25"	Ø 1.25"	4"	1.5"	15.5"	0.125"
3315-1	15"	2.5"	Ø 0.75"	3"	1.5"	18.5"	0.125"
3315-2	15"	3"	Ø 1"	3.5"	1.5"	18.5"	0.125"
3315-3	15"	3.25"	Ø 1.25"	4"	1.5"	18.5"	0.125"

**FEATURED FINISHES:** Flat Black (19), Satin Stainless (32D), Antimicrobial (AM)

**FINISHES:** Standard & Custom Available (See Pages 16 & 17)

**MATERIALS:** Aluminum, Brass, Bronze, Stainless Steel



# DOOR PULLS & PUSH BARS

## STANDARD OFFSET DOOR PULLS

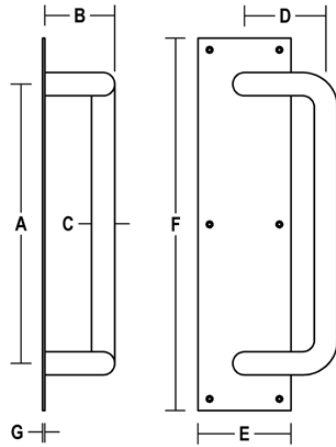

### 3400

#### STANDARD OFFSET DOOR PULL W/ BACKPLATE

NO.	A	B	C	D	E	F	G
3409-1	9"	2.5"	Ø 0.75"	3"	3.5"	15"	0.05"
3409-2	9"	3"	Ø 1"	3.5"	3.5"	15"	0.05"
3409-3	9"	3.25"	Ø 1.25"	4"	3.5"	15"	0.05"
3412-1	12"	2.5"	Ø 0.75"	3"	4"	16"	0.05"
3412-2	12"	3"	Ø 1"	3.5"	4"	16"	0.05"
3412-3	12"	3.25"	Ø 1.25"	4"	4"	16"	0.05"
3415-1	15"	2.5"	Ø 0.75"	3"	4"	20"	0.05"
3415-2	15"	3"	Ø 1"	3.5"	4"	20"	0.05"
3415-3	15"	3.25"	Ø 1.25"	4"	4"	20"	0.05"

Backplate Thickness Code: **A** = 0.05", **B** = 0.06", **C** = 0.125"

**FEATURED FINISHES:** Flat Black (19), Satin Stainless (32D),  
Antimicrobial (AM)

**FINISHES:** Standard & Custom Available (See Pages 16 & 17)

**MATERIALS:** Aluminum, Brass, Bronze, Stainless Steel

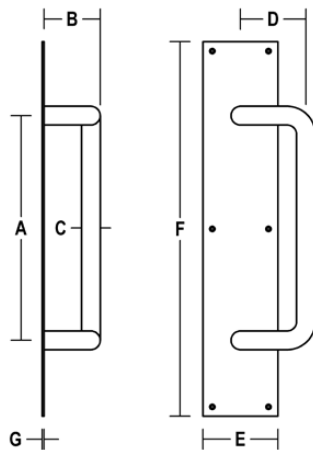

### 3500

#### OFFSET COMMERCIAL DOOR PULL W/ LARGE BACKPLATE

NO.	A	B	C	D	E	F	G
3509-1	9"	2.5"	Ø 0.75"	3"	4"	16"	0.05"
3509-2	9"	3"	Ø 1"	3.5"	4"	16"	0.05"
3509-3	9"	3.25"	Ø 1.25"	4"	4"	16"	0.05"
3512-1	12"	2.5"	Ø 0.75"	3"	4"	20"	0.05"
3512-2	12"	3"	Ø 1"	3.5"	4"	20"	0.05"
3512-3	12"	3.25"	Ø 1.25"	4"	4"	20"	0.05"
3515-1	15"	2.5"	Ø 0.75"	3"	5"	20"	0.05"
3515-2	15"	3"	Ø 1"	3.5"	5"	20"	0.05"
3515-3	15"	3.25"	Ø 1.25"	4"	5"	20"	0.05"

Backplate Thickness Code: **A** = 0.05", **B** = 0.06", **C** = 0.125"

**FEATURED FINISHES:** Flat Black (19), Satin Stainless (32D),  
Antimicrobial (AM)

**FINISHES:** Standard & Custom Available (See Pages 16 & 17)

**MATERIALS:** Aluminum, Brass, Bronze, Stainless Steel



# DOOR PULLS & PUSH BARS

## STANDARD OFFSET DOOR PULLS

## HOW TO ORDER

### 1. SELECT PRODUCT

#### 1. CONFIRM “CENTRE-TO-CENTRE”

LAST TWO DIGITS REPRESENT THE C/C OF PULL

EXAMPLE: 3009

REPRESENTS: [3000 PULL x **9” C/C**]

#### 2. CONFIRM “DIAMETER”

DIAMETER CODES:

- **-1** = 0.75”
- **-2** = 1”
- **-3** = 1.25”

EXAMPLE: 3009-2

REPRESENTS: [3000 PULL x 9” C/C] x **1” DIAMETER**

### 2. SPECIFY MOUNTING (SEE PAGE 18)

CHOOSE FROM:

- #2 = STANDARD SINGLE THRU BOLT MTG
- #4 = SINGLE DECORATIVE MTG
- #4G = SINGLE DECORATIVE GLASS MTG
- #5 = BACK TO BACK MTG
- #5G = BACK TO BACK GLASS MTG
- #6W = SINGLE CONCEALED WOOD MTG
- #6M = SINGLE CONCEALED METAL MTG

EXAMPLE: 3009-2 x #2

REPRESENTS: [3000 PULL x 9” C/C x 1” DIAMETER] x **STANDARD SINGLE THRU BOLT MTG**

### 3. SPECIFY FINISH

**A.** SEE PAGE 16-17 FOR A LIST OF ALL AVAILABLE FINISHES

**B.** CHOOSE FROM FINISHES THAT LIST BASE MATERIALS THAT ARE AVAILABLE FOR YOUR PRODUCT (EACH PRODUCT LISTS AVAILABLE MATERIALS)

**C.** ADD THE “NBHA” OR “BHMA” CODE TO YOUR ORDER

EXAMPLE: 3009-2 x #2 x **C32D**

REPRESENTS: [3000 PULL x 9” C/C x 1” DIAMETER x STANDARD SINGLE THRU BOLT MTG]  
x **SATIN STAINLESS STEEL**

### PUSH/PULL COMBINATION (OPTIONAL): PAIR WITH 6000 PUSH BAR

EXAMPLE: 3012-2 x 6034-2

REPRESENTS: COMBINATION (3000 PULL x 12” C/C x 1” DIAM) x (6000 PUSH BAR x 34” C/C x 1” DIAM)



# DOOR PULLS & PUSH BARS

## STANDARD HALF-ROUND DOOR PULLS

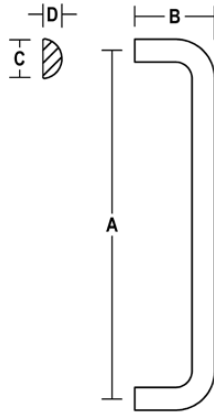

### 9000

#### STANDARD HALF-ROUND DOOR PULL

NO.	A	B	C	D
9005	5"	2"	1"	0.5"
9007	7"	2"	1"	0.5"
9009	9"	2"	1"	0.5"
9012	12"	2"	1"	0.5"

**FEATURED FINISHES:** Flat Black (19), Satin Stainless (32D), Antimicrobial (AM)

**FINISHES:** Standard & Custom Available (See Pages 14 & 15)

**MATERIALS:** Aluminum, Brass, Bronze, Stainless Steel

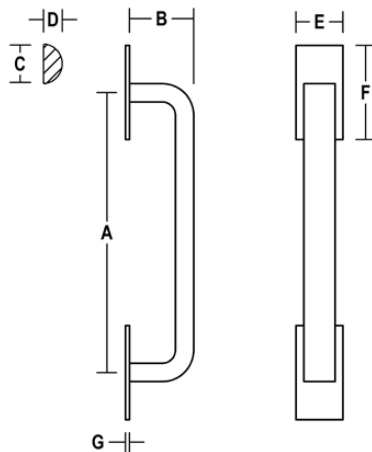
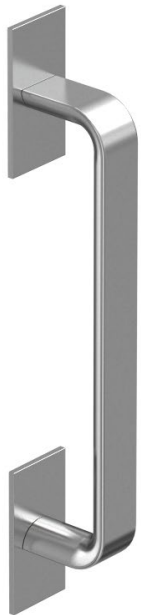

### 9100

#### STANDARD HALF-ROUND DOOR PULL W/ RECTANGULAR BACKPLATES

NO.	A	B	C	D	E	F	G
9105	5"	2"	1"	0.5"	1.5"	3"	0.125"
9107	7"	2"	1"	0.5"	1.5"	3"	0.125"
9109	9"	2"	1"	0.5"	1.5"	3"	0.125"
9112	12"	2"	1"	0.5"	1.5"	3"	0.125"

**FEATURED FINISHES:** Flat Black (19), Satin Stainless (32D), Antimicrobial (AM)

**FINISHES:** Standard & Custom Available (See Pages 14 & 15)

**MATERIALS:** Aluminum, Brass, Bronze, Stainless Steel



# DOOR PULLS & PUSH BARS

## STANDARD HALF-ROUND DOOR PULLS

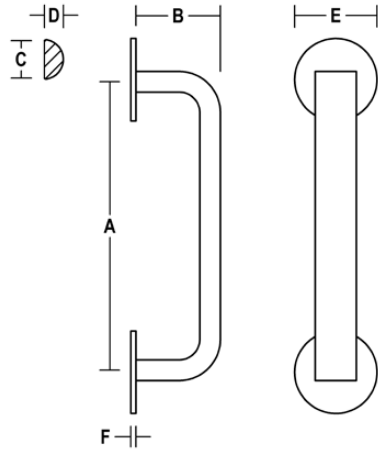
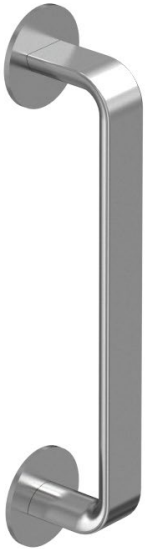

### 9200

#### STANDARD HALF-ROUND DOOR PULL W/ 2" ROSETTES

NO.	A	B	C	D	E	F
9205	5"	2"	1"	0.5"	Ø2"	0.125"
9207	7"	2"	1"	0.5"	Ø2"	0.125"
9209	9"	2"	1"	0.5"	Ø2"	0.125"
9212	12"	2"	1"	0.5"	Ø2"	0.125"

**FEATURED FINISHES:** Flat Black (19), Satin Stainless (32D), Antimicrobial (AM)

**FINISHES:** Standard & Custom Available (See Pages 16 & 17)

**MATERIALS:** Aluminum, Brass, Bronze, Stainless Steel

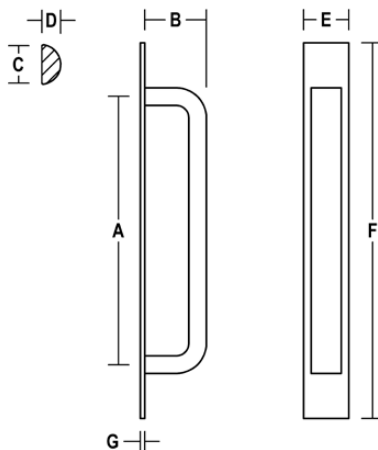

### 9300

#### STANDARD HALF-ROUND DOOR PULL W/ NARROW BACKPLATE

NO.	A	B	C	D	E	F	G
9305	5"	2"	1"	0.5"	1.5"	8.5"	0.125"
9307	7"	2"	1"	0.5"	1.5"	10.5"	0.125"
9309	9"	2"	1"	0.5"	1.5"	12.5"	0.125"
9312	12"	2"	1"	0.5"	1.5"	15.5"	0.125"

**FEATURED FINISHES:** Flat Black (19), Satin Stainless (32D), Antimicrobial (AM)

**FINISHES:** Standard & Custom Available (See Pages 16 & 17)

**MATERIALS:** Aluminum, Brass, Bronze, Stainless Steel



# DOOR PULLS & PUSH BARS

## STANDARD HALF-ROUND DOOR PULLS

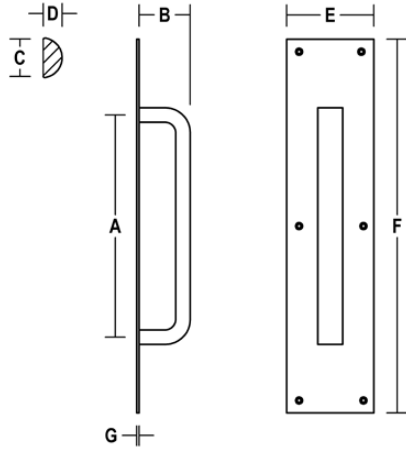

### 9400

#### STANDARD HALF-ROUND DOOR PULL W/ BACKPLATE

NO.	A	B	C	D	E	F	G
9405	5"	2"	1"	0.5"	3"	10"	0.05"
9407	7"	2"	1"	0.5"	3.5"	15"	0.05"
9409	9"	2"	1"	0.5"	3.5"	15"	0.05"
9412	12"	2"	1"	0.5"	4"	16"	0.05"

Backplate Thickness Code: **A** = 0.05", **B** = 0.06", **C** = 0.125"

**FEATURED FINISHES:** Flat Black (19), Satin Stainless (32D), Antimicrobial (AM)

**FINISHES:** Standard & Custom Available (See Pages 16 & 17)

**MATERIALS:** Aluminum, Brass, Bronze, Stainless Steel

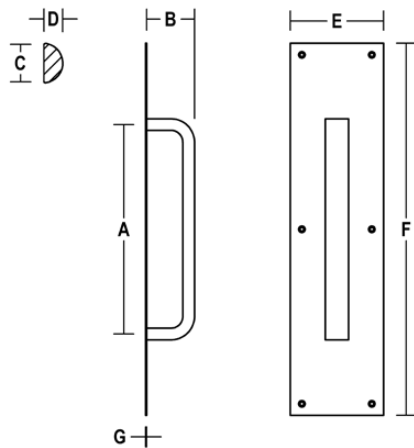

### 9500

#### STANDARD HALF-ROUND DOOR PULL W/ LARGE BACKPLATE

NO.	A	B	C	D	E	F	G
9505	5"	2"	1"	0.5"	3"	12"	0.05"
9507	7"	2"	1"	0.5"	4"	16"	0.05"
9509	9"	2"	1"	0.5"	4"	16"	0.05"
9512	12"	2"	1"	0.5"	4"	20"	0.05"

Backplate Thickness Code: **A** = 0.05", **B** = 0.06", **C** = 0.125"

**FEATURED FINISHES:** Flat Black (19), Satin Stainless (32D), Antimicrobial (AM)

**FINISHES:** Standard & Custom Available (See Pages 16 & 17)

**MATERIALS:** Aluminum, Brass, Bronze, Stainless Steel





# DOOR PULLS & PUSH BARS

## STANDARD HALF-ROUND DOOR PULLS

## HOW TO ORDER

### 1. SELECT PRODUCT

#### 1. CONFIRM “CENTRE-TO-CENTRE”

LAST TWO DIGITS REPRESENT THE C/C OF PULL

EXAMPLE: 9009

REPRESENTS: [9000 PULL x **9” C/C**]

### 2. SPECIFY MOUNTING (SEE PAGE 18)

CHOOSE FROM:

- #2 = STANDARD SINGLE THRU BOLT MTG
- #4 = SINGLE DECORATIVE MTG
- #4G = SINGLE DECORATIVE GLASS MTG
- #5 = BACK TO BACK MTG
- #5G = BACK TO BACK GLASS MTG
- #6W = SINGLE CONCEALED WOOD MTG
- #6M = SINGLE CONCEALED METAL MTG

EXAMPLE: 9009 x **#2**

REPRESENTS: [9000 PULL x 9” C/C] x **STANDARD SINGLE THRU BOLT MTG**

### 3. SPECIFY FINISH

**A.** SEE PAGE 16-17 FOR A LIST OF ALL AVAILABLE FINISHES

**B.** CHOOSE FROM FINISHES THAT LIST BASE MATERIALS THAT ARE AVAILABLE FOR YOUR PRODUCT (EACH PRODUCT LISTS AVAILABLE MATERIALS)

**C.** ADD THE “NBHA” OR “BHMA” CODE TO YOUR ORDER

EXAMPLE: 9009 x #2 x **C32D**

REPRESENTS: [9000 PULL x 9” C/C x STANDARD SINGLE THRU BOLT MTG]  
x **SATIN STAINLESS STEEL**



# DOOR PULLS & PUSH BARS

## COMMERCIAL DOOR PULLS

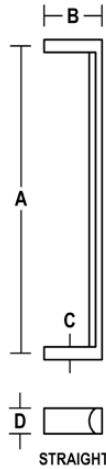

### C320

#### COMMERCIAL DOOR PULL W/ HALF-ROUND GRIP

NO.	A	B	C	D
C320	12"	2.25"	0.5"	1"

**FEATURED FINISHES:** Flat Black (19), Satin Stainless (32D), Antimicrobial (AM)

**FINISHES:** Standard & Custom Available (See Pages 16 & 17)

**MATERIALS:** Brass, Bronze, Stainless Steel

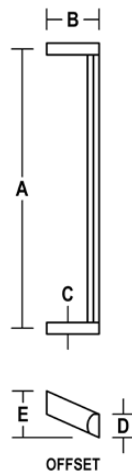

### C321

#### ANGLED OFFSET COMMERCIAL DOOR PULL W/ HALF-ROUND GRIP

NO.	A	B	C	D	E
C321	12"	2.25"	0.5"	1"	2"

**FEATURED FINISHES:** Flat Black (19), Satin Stainless (32D), Antimicrobial (AM)

**FINISHES:** Standard & Custom Available (See Pages 16 & 17)

**MATERIALS:** Brass, Bronze, Stainless Steel

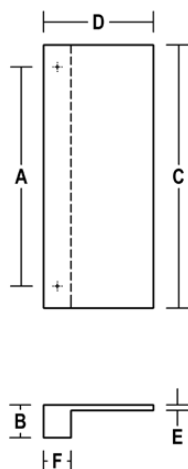

### C322

#### RECTANGULAR OFFSET COMMERCIAL DOOR PULL

NO.	A	B	C	D	E	F
C322	10"	1.75"	12"	5"	0.25"	1.25"

**FEATURED FINISHES:** Flat Black (19), Satin Stainless (32D), Antimicrobial (AM)

**FINISHES:** Standard & Custom Available (See Pages 16 & 17)

**MATERIALS:** Brass, Bronze, Stainless Steel



# DOOR PULLS & PUSH BARS

## COMMERCIAL DOOR PULLS

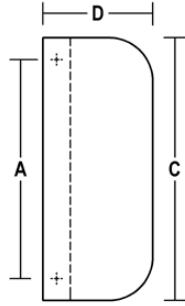

### C323

#### RECTANGULAR OFFSET COMMERCIAL DOOR PULL W/ ROUNDED CORNERS

NO.	A	B	C	D	E	F
C323	10"	1.75"	12"	5"	0.25"	1.25"

**FEATURED FINISHES:** Flat Black (19), Satin Stainless (32D), Antimicrobial (AM)

**FINISHES:** Standard & Custom Available (See Pages 16 & 17)

**MATERIALS:** Brass, Bronze, Stainless Steel

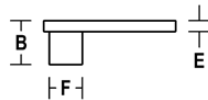
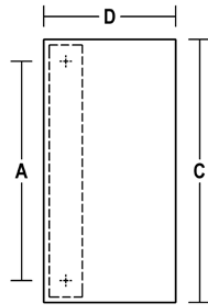

### C327

#### RECTANGULAR OFFSET COMMERCIAL DOOR PULL

NO.	A	B	C	D	E	F
C327	10"	2"	12"	6"	0.5"	1.5"

**FEATURED FINISHES:** Flat Black (19), Satin Stainless (32D), Antimicrobial (AM)

**FINISHES:** Standard & Custom Available (See Pages 16 & 17)

**MATERIALS:** Aluminum, Brass, Bronze, Stainless Steel

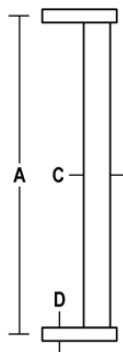

### C340

#### OFFSET COMMERCIAL DOOR PULL

NO.	A	B	C	D	E	F
C340	12"	2.5"	Ø 1"	0.5"	1.5"	1.25"

**FEATURED FINISHES:** Flat Black (19), Satin Aluminum (28), Antimicrobial (AM)

**FINISHES:** Standard & Custom Available (See Pages 16 & 17)

**MATERIAL:** Aluminum



# DOOR PULLS & PUSH BARS

## INSTITUTIONAL PULLS

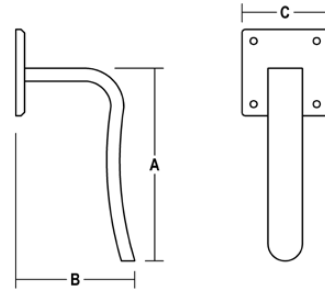

### H417

#### ARM PULL W/ SQUARE BASE

NO.	A	B	C
H417	5.5"	3.5"	□ 2.5"

**FEATURED FINISHES:** Flat Black (19), Satin Stainless (32D), Antimicrobial (AM)

**FINISHES:** Standard & Custom Available (See Pages 16 & 17)

**MATERIALS:** Brass, Bronze, Stainless Steel

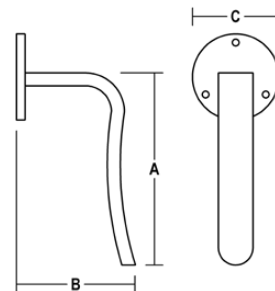

### H418

#### ARM PULL W/ ROUND BASE

NO.	A	B	C
H418	5.5"	3.5"	Ø 2.5"

**FEATURED FINISHES:** Flat Black (19), Satin Stainless (32D), Antimicrobial (AM)

**FINISHES:** Standard & Custom Available (See Pages 16 & 17)

**MATERIALS:** Brass, Bronze, Stainless Steel



# DOOR PULLS & PUSH BARS

## INSTITUTIONAL PULLS

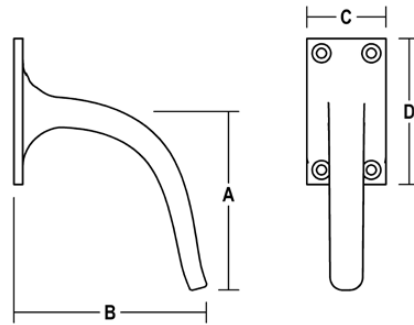

### H419

#### ARM PULL W/ RECTANGULAR BASE

NO.	A	B	C	D
H419	3.625"	4"	1.625"	3"

**FEATURED FINISHES:** Flat Black (19), Satin Chrome (26D), Antimicrobial (AM)

**FINISHES:** Standard & Custom Available (See Pages 16 & 17)

**MATERIAL:** Cast Aluminum, Brass, Bronze

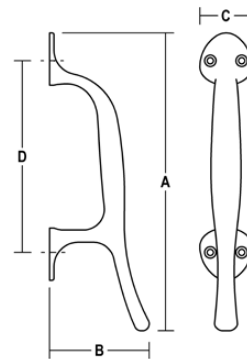

### H420

#### HAND & ARM PULL

NO.	A	B	C	D
H420	9"	3"	1.5"	6"

**FEATURED FINISHES:** Flat Black (19), Satin Chrome (26D), Antimicrobial (AM)

**FINISHES:** Standard & Custom Available (See Pages 16 & 17)

**MATERIALS:** Cast Aluminum, Brass, Bronze



# DOOR PULLS & PUSH BARS

## INSTITUTIONAL PULLS

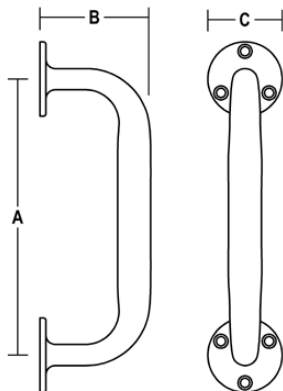

### H421

#### INSTITUTIONAL DOOR PULL W/ EXPOSED MOUNTING

NO.	A	B	C
H421	5.5"	2.25"	Ø 2"

**FEATURED FINISHES:** Flat Black (19), Satin Chrome (26D)

**FINISHES:** Standard & Custom Available (See Pages 16 & 17)

**MATERIALS:** Cast Aluminum, Brass, Bronze



# DOOR PULLS & PUSH BARS

## STANDARD PUSH BARS

### 6000 STANDARD PUSH BAR

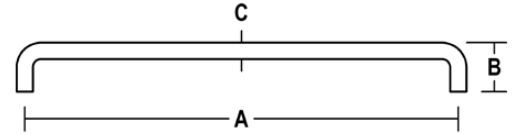

NO.	A	B	C
6030-1	30"	2.5"	Ø 0.75"
6030-2	30"	3"	Ø 1"
6030-3	30"	3.25"	Ø 1.25"
6032-1	32"	2.5"	Ø 0.75"
6032-2	32"	3"	Ø 1"
6032-3	32"	3.25"	Ø 1.25"
6033-1	33"	2.5"	Ø 0.75"
6033-2	33"	3"	Ø 1"
6033-3	33"	3.25"	Ø 1.25"
6034-1	34"	2.5"	Ø 0.75"
6034-2	34"	3"	Ø 1"
6034-3	34"	3.25"	Ø 1.25"

NO.	A	B	C
6036-1	36"	2.5"	Ø 0.75"
6036-2	36"	3"	Ø 1"
6036-3	36"	3.25"	Ø 1.25"

**FEATURED FINISHES:** Flat Black (19), Satin Stainless (32D), Antimicrobial (AM)

**FINISHES:** Standard & Custom Available (See Pages 16 & 17)

**MATERIALS:** Aluminum, Brass, Bronze, Stainless Steel

**PRODUCT OPTIONS:** Combination Push/Pull: Order with 2000/3000 Series Pulls

### 6100 STANDARD PUSH BAR W/ GLASS DOOR ROSSETTES

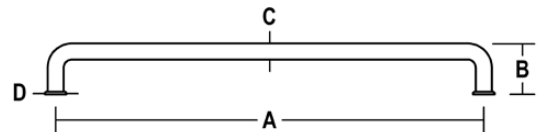

NO.	A	B	C	D
6130-1	30"	2.5"	Ø 0.75"	Ø 1"
6130-2	30"	3"	Ø 1"	Ø 1.25"
6130-3	30"	3.25"	Ø 1.25"	Ø 1.5"
6132-1	32"	2.5"	Ø 0.75"	Ø 1"
6132-2	32"	3"	Ø 1"	Ø 1.25"
6132-3	32"	3.25"	Ø 1.25"	Ø 1.5"
6133-1	33"	2.5"	Ø 0.75"	Ø 1"
6133-2	33"	3"	Ø 1"	Ø 1.25"
6133-3	33"	3.25"	Ø 1.25"	Ø 1.5"
6134-1	34"	2.5"	Ø 0.75"	Ø 1"
6134-2	34"	3"	Ø 1"	Ø 1.25"
6134-3	34"	3.25"	Ø 1.25"	Ø 1.5"

NO.	A	B	C	D
6136-1	36"	2.5"	Ø 0.75"	Ø 1"
6136-2	36"	3"	Ø 1"	Ø 1.25"
6136-3	36"	3.25"	Ø 1.25"	Ø 1.5"

**FEATURED FINISHES:** Flat Black (19), Satin Stainless (32D), Antimicrobial (AM)

**FINISHES:** Standard & Custom Available (See Pages 16 & 17)

**MATERIALS:** Aluminum, Brass, Bronze, Stainless Steel

**PRODUCT OPTIONS:** Combination Push/Pull: Order with 2000/3000 Series Pulls



# DOOR PULLS & PUSH BARS

## STANDARD PUSH BARS

### 6200

#### STANDARD DOUBLE PUSH BAR

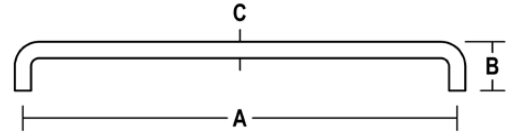

NO.	A	B	C
6230-1	30"	2.5"	Ø 0.75"
6230-2	30"	3"	Ø 1"
6230-3	30"	3.25"	Ø 1.25"
6232-1	32"	2.5"	Ø 0.75"
6232-2	32"	3"	Ø 1"
6232-3	32"	3.25"	Ø 1.25"
6233-1	33"	2.5"	Ø 0.75"
6233-2	33"	3"	Ø 1"
6233-3	33"	3.25"	Ø 1.25"
6234-1	34"	2.5"	Ø 0.75"
6234-2	34"	3"	Ø 1"
6234-3	34"	3.25"	Ø 1.25"

NO.	A	B	C
6236-1	36"	2.5"	Ø 0.75"
6236-2	36"	3"	Ø 1"
6236-3	36"	3.25"	Ø 1.25"

**FEATURED FINISHES:** Flat Black (19), Satin Stainless (32D), Antimicrobial (AM)

**FINISHES:** Standard & Custom Available (See Pages 16 & 17)

**MATERIALS:** Aluminum, Brass, Bronze, Stainless Steel

**PRODUCT OPTIONS:** Combination Push/Pull: Order with 2000/3000 Series Pulls

### 6300

#### STANDARD DOUBLE PUSH BAR W/ GLASS DOOR ROSSETTES

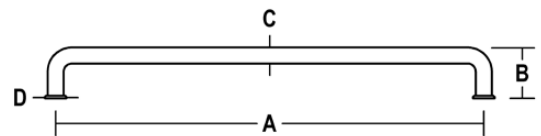

NO.	A	B	C	D
6330-1	30"	2.5"	Ø 0.75"	Ø 1"
6330-2	30"	3"	Ø 1"	Ø 1.25"
6330-3	30"	3.25"	Ø 1.25"	Ø 1.5"
6332-1	31"	2.5"	Ø 0.75"	Ø 1"
6332-2	31"	3"	Ø 1"	Ø 1.25"
6332-3	31"	3.25"	Ø 1.25"	Ø 1.5"
6333-1	32"	2.5"	Ø 0.75"	Ø 1"
6333-2	32"	3"	Ø 1"	Ø 1.25"
6333-3	32"	3.25"	Ø 1.25"	Ø 1.5"
6334-1	34"	2.5"	Ø 0.75"	Ø 1"
6334-2	34"	3"	Ø 1"	Ø 1.25"
6334-3	34"	3.25"	Ø 1.25"	Ø 1.5"

NO.	A	B	C	D
6336-1	36"	2.5"	Ø 0.75"	Ø 1"
6336-2	36"	3"	Ø 1"	Ø 1.25"
6336-3	36"	3.25"	Ø 1.25"	Ø 1.5"

**FEATURED FINISHES:** Flat Black (19), Satin Stainless (32D), Antimicrobial (AM)

**FINISHES:** Standard & Custom Available (See Pages 16 & 17)

**MATERIALS:** Aluminum, Brass, Bronze, Stainless Steel

**PRODUCT OPTIONS:** Combination Push/Pull: Order with 2000/3000 Series Pulls





# DOOR PULLS & PUSH BARS

## STANDARD PUSH BARS

### 6400

#### STANDARD DOUBLE PUSH BAR W/ OVAL BACKPLATES

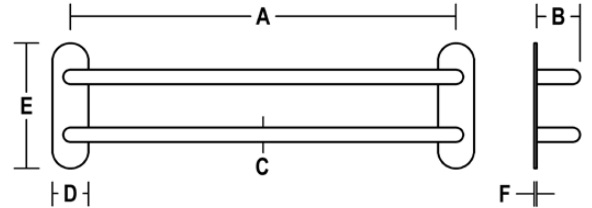

NO.	A	B	C	D	E	F
6430-1	30"	2.5"	Ø 0.75"	2"	6.5"	0.125"
6430-2	30"	3"	Ø 1"	2"	6.5"	0.125"
6430-3	30"	3.25"	Ø 1.25"	2"	6.5"	0.125"
6432-1	32"	2.5"	Ø 0.75"	2"	6.5"	0.125"
6432-2	32"	3"	Ø 1"	2"	6.5"	0.125"
6432-3	32"	3.25"	Ø 1.25"	2"	6.5"	0.125"
6433-1	33"	2.5"	Ø 0.75"	2"	6.5"	0.125"
6433-2	33"	3"	Ø 1"	2"	6.5"	0.125"
6433-3	33"	3.25"	Ø 1.25"	2"	6.5"	0.125"
6434-1	34"	2.5"	Ø 0.75"	2"	6.5"	0.125"
6434-2	34"	3"	Ø 1"	2"	6.5"	0.125"
6434-3	34"	3.25"	Ø 1.25"	2"	6.5"	0.125"

NO.	A	B	C	D	E	F
6436-1	36"	2.5"	Ø 0.75"	2"	6.5"	0.125"
6436-2	36"	3"	Ø 1"	2"	6.5"	0.125"
6436-3	36"	3.25"	Ø 1.25"	2"	6.5"	0.125"

**FEATURED FINISHES:** Flat Black (19), Satin Stainless (32D), Antimicrobial (AM)

**FINISHES:** Standard & Custom Available (See Pages 16 & 17)

**MATERIALS:** Aluminum, Brass, Bronze, Stainless Steel

**PRODUCT OPTIONS:** Combination Push/Pull: Order with 2000/3000 Series Pulls

### 6500

#### STANDARD TRIPLE PUSH BAR W/ OVAL BACKPLATES

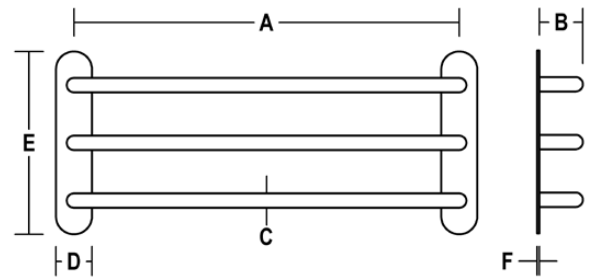

NO.	A	B	C	D	E	F
6530-1	30"	2.5"	Ø 0.75"	2"	9.5"	0.125"
6530-2	30"	3"	Ø 1"	2"	9.5"	0.125"
6530-3	30"	3.25"	Ø 1.25"	2"	9.5"	0.125"
6532-1	32"	2.5"	Ø 0.75"	2"	9.5"	0.125"
6532-2	32"	3"	Ø 1"	2"	9.5"	0.125"
6532-3	32"	3.25"	Ø 1.25"	2"	9.5"	0.125"
6533-1	33"	2.5"	Ø 0.75"	2"	9.5"	0.125"
6533-2	33"	3"	Ø 1"	2"	9.5"	0.125"
6533-3	33"	3.25"	Ø 1.25"	2"	9.5"	0.125"
6534-1	34"	2.5"	Ø 0.75"	2"	9.5"	0.125"
6534-2	34"	3"	Ø 1"	2"	9.5"	0.125"
6534-3	34"	3.25"	Ø 1.25"	2"	9.5"	0.125"

NO.	A	B	C	D	E	F
6536-1	36"	2.5"	Ø 0.75"	2"	9.5"	0.125"
6536-2	36"	3"	Ø 1"	2"	9.5"	0.125"
6536-3	36"	3.25"	Ø 1.25"	2"	9.5"	0.125"

**FEATURED FINISHES:** Flat Black (19), Satin Stainless (32D), Antimicrobial (AM)

**FINISHES:** Standard & Custom Available (See Pages 16 & 17)

**MATERIALS:** Aluminum, Brass, Bronze, Stainless Steel

**PRODUCT OPTIONS:** Combination Push/Pull: Order with 2000/3000 Series Pulls



# DOOR PULLS & PUSH BARS

## STANDARD PUSH BARS

---

## HOW TO ORDER

### 1. SELECT PRODUCT

#### 1. CONFIRM “CENTRE-TO-CENTRE”

LAST TWO DIGITS REPRESENT THE C/C OF PUSH BAR

EXAMPLE: 6032

REPRESENTS: [6000 PUSH BAR x **32” C/C**]

#### 2. CONFIRM “DIAMETER”

DIAMETER CODES:

- **-1** = 0.75”
- **-2** = 1”
- **-3** = 1.25”

EXAMPLE: 6032 **-3**

REPRESENTS: [6000 PUSH BAR x 32” C/C] x **1.25” DIAMETER**

### 2. SPECIFY MOUNTING (SEE PAGE 18)

CHOOSE FROM:

- #2 = STANDARD SINGLE THRU BOLT MTG
- #4 = SINGLE DECORATIVE MTG
- #4G = SINGLE DECORATIVE GLASS MTG
- #5 = BACK TO BACK MTG
- #5G = BACK TO BACK GLASS MTG
- #6W = SINGLE CONCEALED WOOD MTG
- #6M = SINGLE CONCEALED METAL MTG

EXAMPLE: 6032-3 x **#2**

REPRESENTS: [6000 PUSH BAR x 32” C/C x 1.25” DIAMETER]  
x **STANDARD SINGLE THRU BOLT MTG**

### 3. SPECIFY FINISH

**A.** SEE PAGE 16-17 FOR A LIST OF ALL AVAILABLE FINISHES

**B.** CHOOSE FROM FINISHES THAT LIST BASE MATERIALS THAT ARE AVAILABLE FOR YOUR PRODUCT (EACH PRODUCT LISTS AVAILABLE MATERIALS)

**C.** ADD THE “NBHA” OR “BHMA” CODE TO YOUR ORDER

EXAMPLE: 6032-3 x #2 x **C32D**

REPRESENTS: [6000 PUSH BAR x 32” C/C x 1.25” DIAMETER  
x STANDARD SINGLE THRU BOLT MTG] x **SATIN STAINLESS STEEL**

### PUSH/PULL COMBINATION (OPTIONAL): PAIR WITH 2000 OR 3000 PULL

EXAMPLE: 3012-2 x 6034-2

REPRESENTS: COMBINATION (3000 PULL x 12” C/C x 1” DIAM) x (6000 PUSH BAR x 34” C/C x 1” DIAM)



# DOOR PULLS & PUSH BARS

## COMMERCIAL PUSH BARS

### B301 COMMERCIAL PUSH BAR

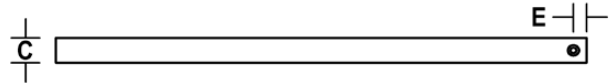

NO.	A	B	C	D	E
B301	SPECIFY	2.25"	1.5"	0.5"	0.75"

**FEATURED FINISHES:** Flat Black (19), Satin Stainless (32D), Antimicrobial (AM)

**FINISHES:** Standard & Custom Available (See Pages 16 & 17)

**MATERIALS:** Aluminum, Brass, Bronze, Stainless Steel

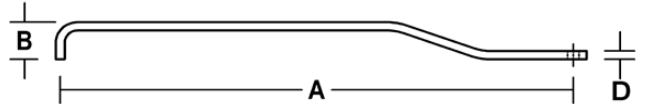

### B302 COMMERCIAL PUSH BAR

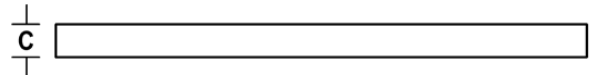

NO.	A	B	C	D
B302	SPECIFY	2.25"	2"	0.5"

**FEATURED FINISHES:** Flat Black (19), Satin Stainless (32D), Antimicrobial (AM)

**FINISHES:** Standard & Custom Available (See Pages 16 & 17)

**MATERIALS:** Aluminum, Brass, Bronze, Stainless Steel

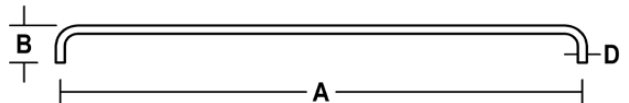

### B303 COMMERCIAL PUSH BAR

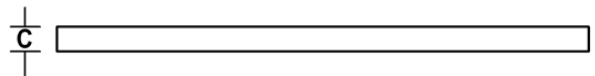

NO.	A	B	C	D
B303	SPECIFY	2.25"	1.5"	0.5"

**FEATURED FINISHES:** Flat Black (19), Satin Stainless (32D), Antimicrobial (AM)

**FINISHES:** Standard & Custom Available (See Pages 16 & 17)

**MATERIALS:** Aluminum, Brass, Bronze, Stainless Steel

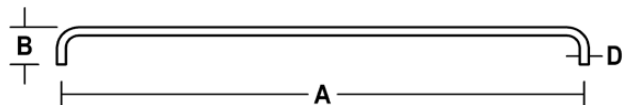



# DOOR PULLS & PUSH BARS

## COMMERCIAL PUSH BARS



### B304 COMMERCIAL PUSH BAR

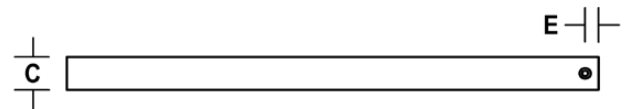

NO.	A	B	C	D	E
B304	SPECIFY	2.25"	2"	0.5"	0.75"

**FEATURED FINISHES:** Flat Black (19), Satin Stainless (32D), Antimicrobial (AM)

**FINISHES:** Standard & Custom Available (See Pages 16 & 17)

**MATERIALS:** Aluminum, Brass, Bronze, Stainless Steel



### B305 COMMERCIAL PUSH BAR

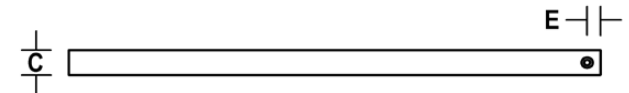

NO.	A	B	C	D	E
B305	SPECIFY	2.25"	1.5"	0.5"	0.75"

**FEATURED FINISHES:** Flat Black (19), Satin Stainless (32D), Antimicrobial (AM)

**FINISHES:** Standard & Custom Available (See Pages 16 & 17)

**MATERIALS:** Aluminum, Brass, Bronze, Stainless Steel





# DOOR PULLS & PUSH BARS

## COMMERCIAL PUSH BARS



### B309 COMMERCIAL PUSH BAR W/ BASE PLATES

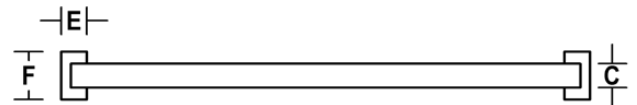

NO.	A	B	C	D	E	F
B309	SPECIFY	2.25"	1.5"	0.375"	1.5"	3"

**FEATURED FINISHES:** Flat Black (19), Satin Stainless (32D), Antimicrobial (AM)

**FINISHES:** Standard & Custom Available (See Pages 16 & 17)

**MATERIALS:** Aluminum, Brass, Bronze, Stainless Steel

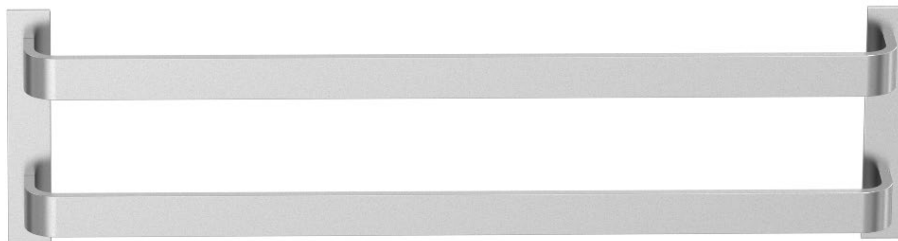
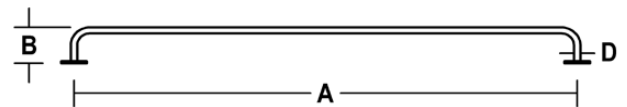

### B310 COMMERCIAL DOUBLE PUSH BAR W/ BASE PLATES

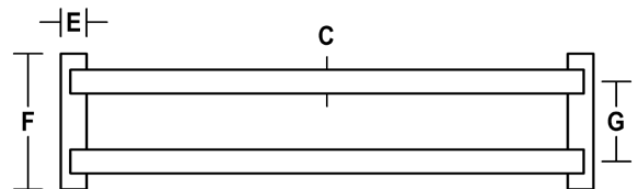

NO.	A	B	C	D	E	F	G
B310	SPECIFY	2.25"	1.5"	0.375"	1.5"	8.5"	5"

**FEATURED FINISHES:** Flat Black (19), Satin Stainless (32D), Antimicrobial (AM)

**FINISHES:** Standard & Custom Available (See Pages 16 & 17)

**MATERIALS:** Aluminum, Brass, Bronze, Stainless Steel

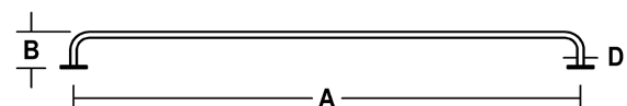



# DOOR PULLS & PUSH BARS

## COMMERCIAL PUSH BARS



### B311 COMMERCIAL PUSH BAR W/ BASE PLATE

NO.	A	B	C	D	E	F	G
B311	SPECIFY	2.25"	1.5"	0.375"	1.5"	3"	0.75"

**FEATURED FINISHES:** Flat Black (19), Satin Stainless (32D), Antimicrobial (AM)

**FINISHES:** Standard & Custom Available (See Pages 16 & 17)

**MATERIALS:** Aluminum, Brass, Bronze, Stainless Steel

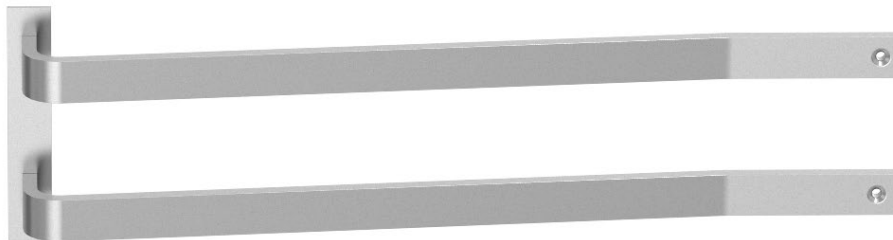
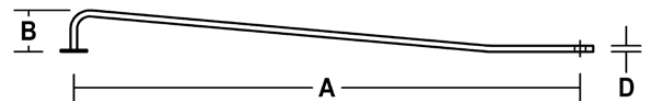
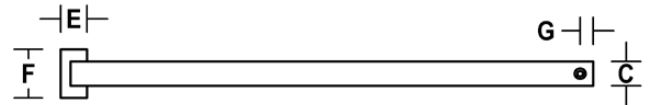

### B312 COMMERCIAL DOUBLE PUSH BAR W/ BASE PLATE

NO.	A	B	C	D	E	F	G	H
B312	SPECIFY	2.25"	1.5"	0.375"	1.5"	8.5"	5"	0.75"

**FEATURED FINISHES:** Flat Black (19), Satin Stainless (32D), Antimicrobial (AM)

**FINISHES:** Standard & Custom Available (See Pages 16 & 17)

**MATERIALS:** Aluminum, Brass, Bronze, Stainless Steel

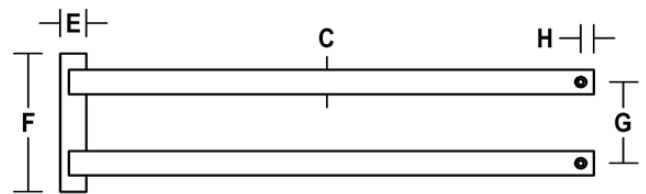



# DOOR PULLS & PUSH BARS

## COMMERCIAL PUSH BARS



### B313

#### COMMERCIAL PUSH BAR W/ BASE PLATE

NO.	A	B	C	D	E	F	G
B313	SPECIFY	2.25"	1.5"	0.375"	1.5"	3"	0.75"

**FEATURED FINISHES:** Flat Black (19), Satin Stainless (32D), Antimicrobial (AM)

**FINISHES:** Standard & Custom Available (See Pages 16 & 17)

**MATERIALS:** Aluminum, Brass, Bronze, Stainless Steel

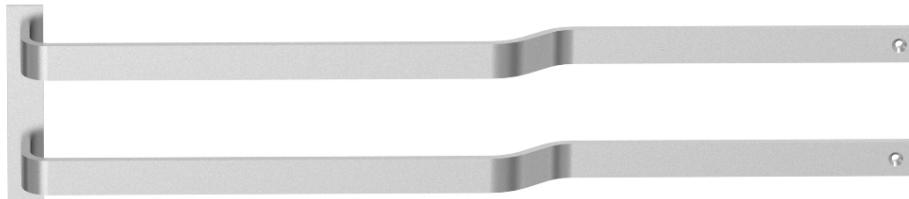
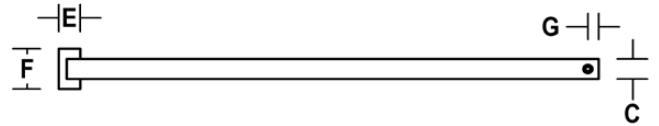

### B314

#### COMMERCIAL DOUBLE PUSH BAR W/ BASE PLATE

NO.	A	B	C	D	E	F	G	H
B314	SPECIFY	2.25"	1.5"	0.375"	1.5"	8.5"	5"	0.75"

**FEATURED FINISHES:** Flat Black (19), Satin Stainless (32D), Antimicrobial (AM)

**FINISHES:** Standard & Custom Available (See Pages 16 & 17)

**MATERIALS:** Aluminum, Brass, Bronze, Stainless Steel

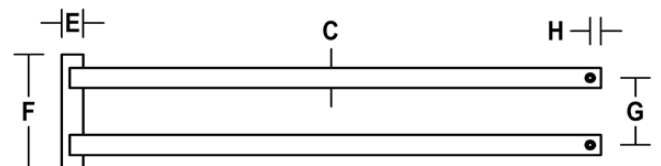



# DOOR PULLS & PUSH BARS

## COMMERCIAL PUSH BARS

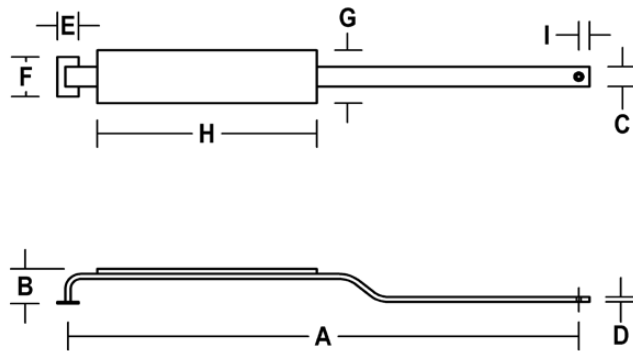
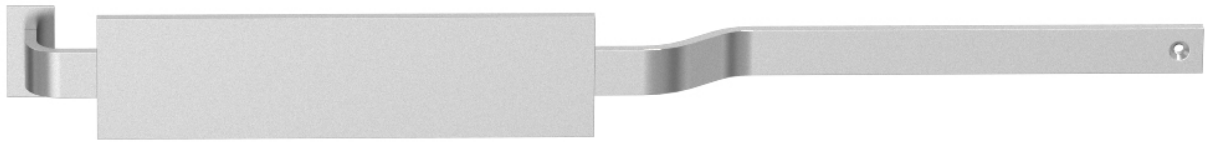

### **B315**

#### **COMMERCIAL PUSH BAR W/ PUSH PLATE**

NO.	A	B	C	D	E	F	G	H	I
<b>B315</b>	SPECIFY	2.5"	1.5"	0.375"	1.5"	3"	4"	15.5"	0.75"

**FEATURED FINISHES:** Flat Black (19), Satin Stainless (32D),  
Antimicrobial (AM)

**FINISHES:** Standard & Custom Available (See Pages 16 & 17)

**MATERIALS:** Aluminum, Brass, Bronze, Stainless Steel





# DOOR PULLS & PUSH BARS

## COMMERCIAL PUSH BARS

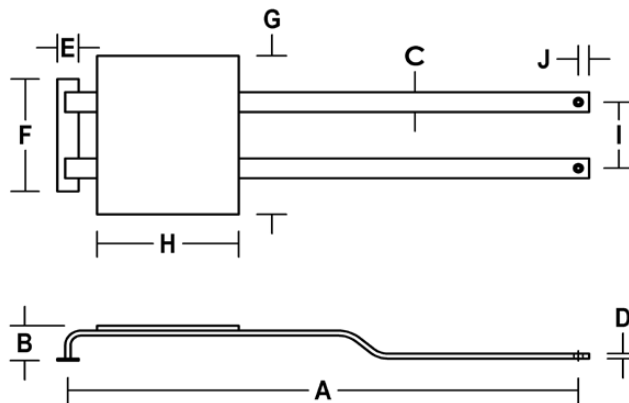
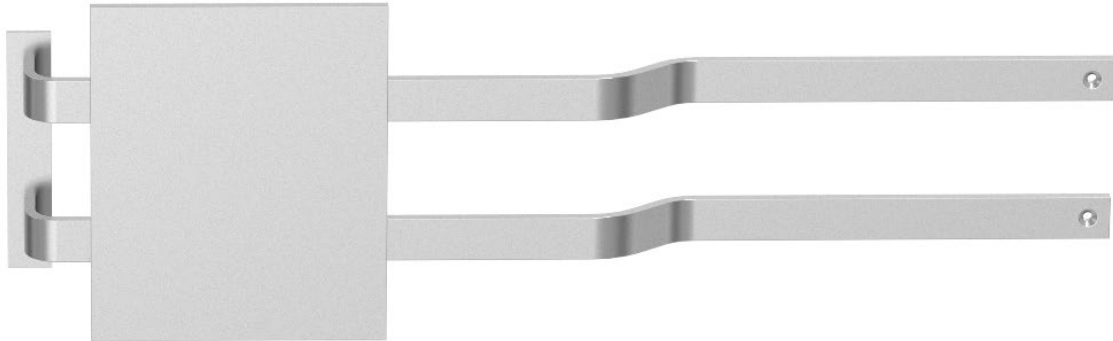

### **B317**

#### **COMMERCIAL DOUBLE PUSH BAR W/ PUSH PLATE**

<b>NO.</b>	<b>A</b>	<b>B</b>	<b>C</b>	<b>D</b>	<b>E</b>	<b>F</b>	<b>G</b>	<b>H</b>	<b>I</b>	<b>J</b>
<b>B317</b>	SPECIFY	2.5"	1.5"	0.375"	1.5"	8.5"	12"	10"	5"	0.75"

**FEATURED FINISHES:** Flat Black (19), Satin Stainless (32D),  
Antimicrobial (AM)

**FINISHES:** Standard & Custom Available (See Pages 16 & 17)

**MATERIALS:** Aluminum, Brass, Bronze, Stainless Steel



# ARCHITECTURAL DOOR PULLS



- 52** MODERN STRAIGHT
- 57** MODERN CURVES
- 62** MODERN ANGLES
- 67** MODERN FLAT
- 73** MODERN RECTANGULAR
- 76** MODERN SQUARE
- 78** WOOD
- 86** LEATHER

- 89** RUBBER
- 92** SPLIT FINISH
- 94** REEDED
- 95** GROOVES
- 98** HEX
- 100** CIRCULAR
- 104** TRADITIONAL
- 108** CLASSIC
- 112** INSPIRED DESIGN





# ARCHITECTURAL DOOR PULLS

## MODERN STRAIGHT

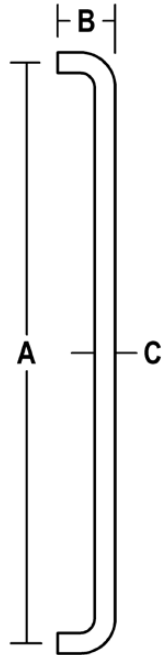

### D351

#### STRAIGHT PULL - BENT ENDS

NO.	A	B	C
D351-1	SPECIFY	2.5"	Ø 0.75"
D351-2	SPECIFY	3"	Ø 1"
D351-3	SPECIFY	3.25"	Ø 1.25"
D351-4	SPECIFY	3.5"	Ø 1.5"

**FEATURED FINISHES:** Flat Black (19), Satin Stainless (32D), Antimicrobial (AM)

**FINISHES:** Standard & Custom Available (See Pages 16 & 17)

**MATERIALS:** Aluminum, Brass, Bronze, Stainless Steel

**PRODUCT OPTIONS:** Custom Lengths Available

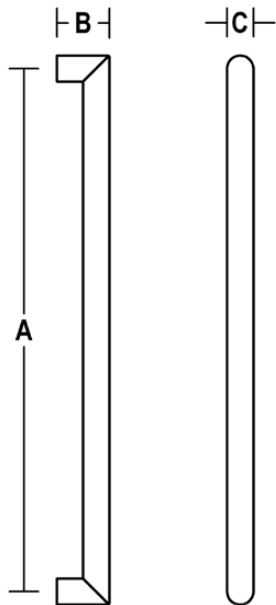
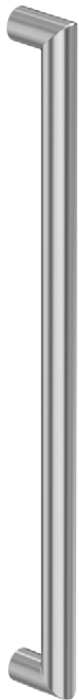

### D460

#### STRAIGHT PULL W/ MITERED ENDS

NO.	A	B	C
D460-1	SPECIFY	2.5"	Ø 0.75"
D460-2	SPECIFY	2.75"	Ø 1"
D460-3	SPECIFY	3"	Ø 1.25"
D460-4	SPECIFY	3.25"	Ø 1.5"

**FEATURED FINISHES:** Flat Black (19), Satin Stainless (32D), Antimicrobial (AM)

**FINISHES:** Standard & Custom Available (See Pages 16 & 17)

**MATERIALS:** Aluminum, Brass, Bronze, Stainless Steel

**PRODUCT OPTIONS:** Custom Lengths Available



# ARCHITECTURAL DOOR PULLS

## MODERN STRAIGHT

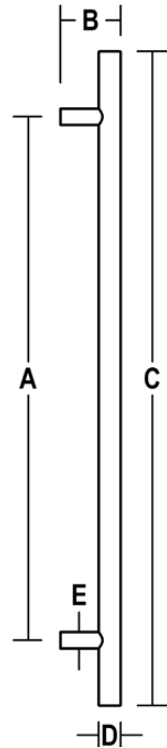

### D352

#### STRAIGHT PULL

#### W/ STANDARD POSTS - FLAT ENDS

NO.	A	B	C	D	E
D352-1	SPECIFY	2.5"	SPECIFY	Ø 0.75"	Ø 0.75"
D352-2	SPECIFY	2.75"	SPECIFY	Ø 1"	Ø 0.75"
D352-3	SPECIFY	3"	SPECIFY	Ø 1.25"	Ø 0.875"
D352-4	SPECIFY	3.25"	SPECIFY	Ø 1.5"	Ø 0.875"

**FEATURED FINISHES:** Flat Black (19), Satin Stainless (32D), Antimicrobial (AM)

**FINISHES:** Standard & Custom Available (See Pages 16 & 17)

**MATERIALS:** Aluminum, Brass, Bronze, Stainless Steel

**PRODUCT OPTIONS:** Custom Lengths Available

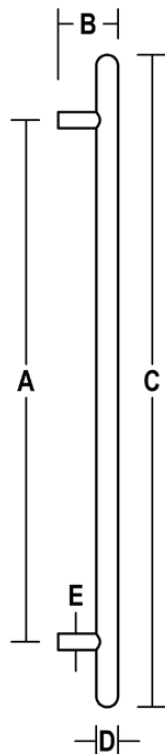

### D354

#### STRAIGHT PULL

#### W/ STANDARD POSTS - ROUND ENDS

NO.	A	B	C	D	E
D354-1	SPECIFY	2.5"	SPECIFY	Ø 0.75"	Ø 0.75"
D354-2	SPECIFY	2.75"	SPECIFY	Ø 1"	Ø 0.75"
D354-3	SPECIFY	3"	SPECIFY	Ø 1.25"	Ø 0.875"
D354-4	SPECIFY	3.25"	SPECIFY	Ø 1.5"	Ø 0.875"

**FEATURED FINISHES:** Flat Black (19), Satin Stainless (32D), Antimicrobial (AM)

**FINISHES:** Standard & Custom Available (See Pages 16 & 17)

**MATERIALS:** Aluminum, Brass, Bronze, Stainless Steel

**PRODUCT OPTIONS:** Custom Lengths Available



# ARCHITECTURAL DOOR PULLS

## MODERN STRAIGHT

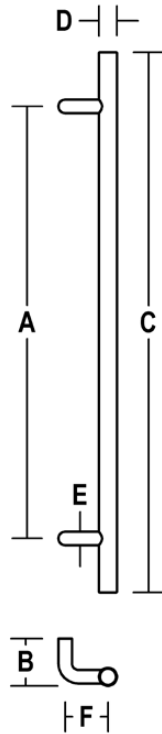

### D452

#### STRAIGHT PULL W/ STANDARD OFFSET POST - FLAT ENDS

NO.	A	B	C	D	E	F
D452-1	SPECIFY	2.375"	SPECIFY	Ø 0.75"	Ø 0.5"	2.25"
D452-2	SPECIFY	2.625"	SPECIFY	Ø 1"	Ø 0.75"	2.375"
D452-3	SPECIFY	2.75"	SPECIFY	Ø 1.25"	Ø 0.75"	2.5"
D452-4	SPECIFY	2.875"	SPECIFY	Ø 1.5"	Ø 0.75"	2.625"

**FEATURED FINISHES:** Flat Black (19), Satin Stainless (32D), Antimicrobial (AM)

**FINISHES:** Standard & Custom Available (See Pages 16 & 17)

**MATERIALS:** Aluminum, Brass, Bronze, Stainless Steel

**PRODUCT OPTIONS:** Custom Lengths Available

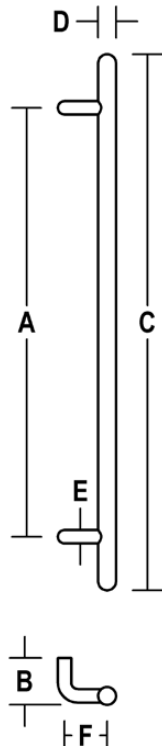

### D454

#### STRAIGHT PULL W/ STANDARD OFFSET POST - ROUND ENDS

NO.	A	B	C	D	E	F
D454-1	SPECIFY	2.375"	SPECIFY	Ø 0.75"	Ø 0.5"	2.25"
D454-2	SPECIFY	2.625"	SPECIFY	Ø 1"	Ø 0.75"	2.375"
D454-3	SPECIFY	2.75"	SPECIFY	Ø 1.25"	Ø 0.75"	2.5"
D454-4	SPECIFY	2.875"	SPECIFY	Ø 1.5"	Ø 0.75"	2.625"

**FEATURED FINISHES:** Flat Black (19), Satin Stainless (32D), Antimicrobial (AM)

**FINISHES:** Standard & Custom Available (See Pages 16 & 17)

**MATERIALS:** Aluminum, Brass, Bronze, Stainless Steel

**PRODUCT OPTIONS:** Custom Lengths Available



# ARCHITECTURAL DOOR PULLS

## MODERN STRAIGHT

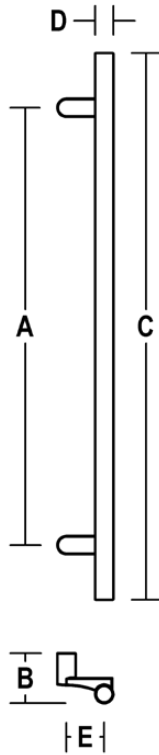

### D453

#### STRAIGHT PULL W/ OFFSET "H" POST - FLAT ENDS

NO.	A	B	C	D	E
D453-2	SPECIFY	2.75"	SPECIFY	Ø 1"	2"
D453-3	SPECIFY	3"	SPECIFY	Ø 1.25"	2"

**FEATURED FINISHES:** Flat Black (19), Satin Stainless (32D), Antimicrobial (AM)

**FINISHES:** Standard & Custom Available (See Pages 16 & 17)

**MATERIALS:** Aluminum, Brass, Bronze, Stainless Steel

**PRODUCT OPTIONS:** Custom Lengths Available

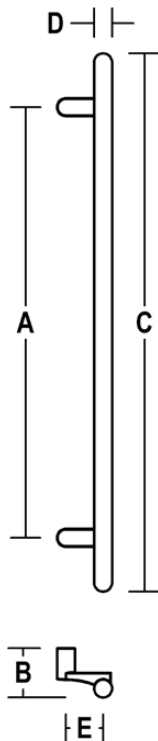

### D455

#### STRAIGHT PULL W/ OFFSET "H" POSTS - ROUND ENDS

NO.	A	B	C	D	E
D455-2	SPECIFY	2.75"	SPECIFY	Ø 1"	2"
D455-3	SPECIFY	3"	SPECIFY	Ø 1.25"	2"

**FEATURED FINISHES:** Flat Black (19), Satin Stainless (32D), Antimicrobial (AM)

**FINISHES:** Standard & Custom Available (See Pages 16 & 17)

**MATERIALS:** Aluminum, Brass, Bronze, Stainless Steel

**PRODUCT OPTIONS:** Custom Lengths Available



# ARCHITECTURAL DOOR PULLS

## MODERN STRAIGHT

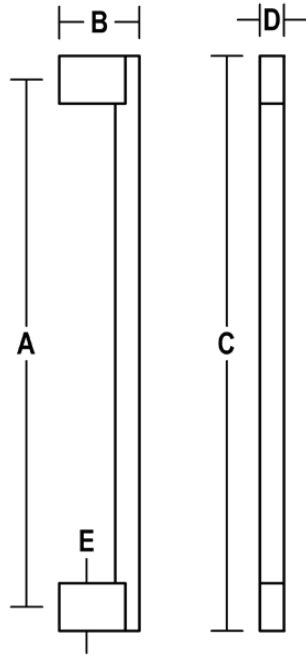

### D640 STRAIGHT PULL W/ RECTANGULAR END POSTS

NO.	A	B	C	D	E
D640-1	16.5"	2.5"	18"	Ø 0.75"	1.5"
D640-2	16.5"	2.75"	18"	Ø 1"	1.5"
D640-3	16.5"	3"	18"	Ø 1.25"	2"

**FEATURED FINISHES:** Flat Black (19), Satin Stainless (32D), Antimicrobial (AM)

**FINISHES:** Standard & Custom Available (See Pages 16 & 17)

**MATERIALS:** Aluminum, Brass, Bronze, Stainless Steel

**PRODUCT OPTIONS:** Custom Lengths Available

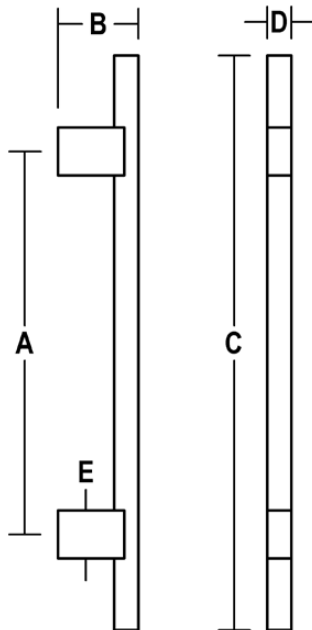

### D641 STRAIGHT PULL W/ RECTANGULAR POSTS

NO.	A	B	C	D	E
D641-1	12"	2.5"	18"	Ø 0.75"	1.5"
D641-2	12"	2.75"	18"	Ø 1"	1.5"
D641-3	12"	3"	18"	Ø 1.25"	2"

**FEATURED FINISHES:** Flat Black (19), Satin Stainless (32D), Antimicrobial (AM)

**FINISHES:** Standard & Custom Available (See Pages 16 & 17)

**MATERIALS:** Aluminum, Brass, Bronze, Stainless Steel

**PRODUCT OPTIONS:** Custom Lengths Available





# ARCHITECTURAL DOOR PULLS

## MODERN CURVES

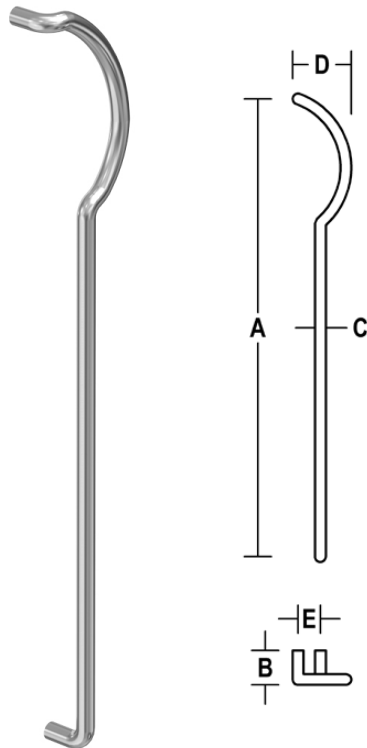

### D356

#### STRAIGHT PULL W/ CURVED GRIP - BENT ENDS

NO.	A	B	C	D	E
D356-1	42"	2.5"	Ø 0.75"	6.5"	2.75"
D356-2	42"	3"	Ø 1"	6.5"	2.75"
D356-3	42"	3.25"	Ø 1.25"	6.5"	2.75"
D356-4	42"	3.5"	Ø 1.5"	6.5"	2.75"

**FEATURED FINISHES:** Flat Black (19), Satin Stainless (32D), Antimicrobial (AM)

**FINISHES:** Standard & Custom Available (See Pages 16 & 17)

**MATERIALS:** Aluminum, Brass, Bronze, Stainless Steel

**PRODUCT OPTIONS:** Custom Lengths Available

**PRODUCT NOTES:** Handed Product (RH is shown)



### D359

#### S-SHAPE HORIZONTAL PUSH/PULL



NO.	A	B	C	D
D359-1	36.5"	2.5"	Ø 0.75"	2.125"
D359-2	36.5"	3"	Ø 1"	2.25"
D359-3	36.5"	3.25"	Ø 1.25"	2.375"
D359-4	36.5"	3.5"	Ø 1.5"	2.5"

**FEATURED FINISHES:** Flat Black (19), Satin Stainless (32D), Antimicrobial (AM)

**FINISHES:** Standard & Custom Available (See Pages 16 & 17)

**MATERIALS:** Aluminum, Brass, Bronze, Stainless Steel

**PRODUCT NOTES:** Handed Product (LH is shown)

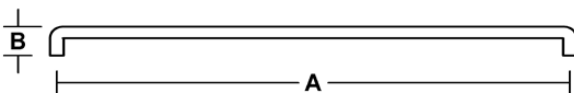



# ARCHITECTURAL DOOR PULLS

## MODERN CURVES

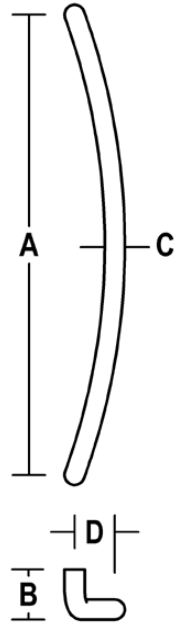

### D370

#### CURVED OFFSET PULL

NO.	A	B	C	D
D370	23"	3"	Ø 1"	3"

**FEATURED FINISHES:** Flat Black (19), Satin Stainless (32D), Antimicrobial (AM)

**FINISHES:** Standard & Custom Available (See Pages 16 & 17)

**MATERIALS:** Aluminum, Brass, Bronze, Stainless Steel

**PRODUCT OPTIONS:** Custom Lengths Available

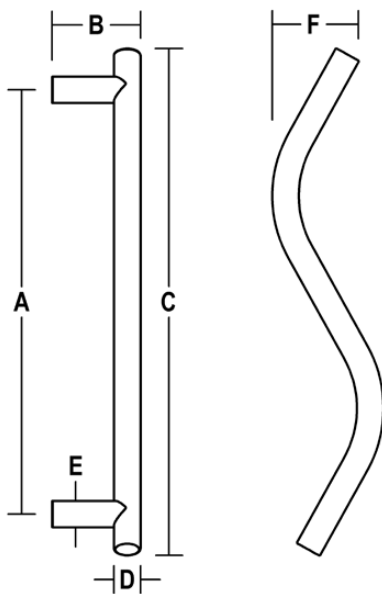

### D378

#### S-SHAPE PULL

NO.	A	B	C	D	E	F
D378	12"	2.5"	14"	Ø 0.75"	Ø 0.75	2.5"

**FEATURED FINISHES:** Flat Black (19), Satin Stainless (32D), Antimicrobial (AM)

**FINISHES:** Standard & Custom Available (See Pages 16 & 17)

**MATERIALS:** Aluminum, Brass, Bronze, Stainless Steel

**PRODUCT OPTIONS:** Custom Lengths Available

**PRODUCT NOTES:** Handed Product (LH is shown)



# ARCHITECTURAL DOOR PULLS

## MODERN CURVES

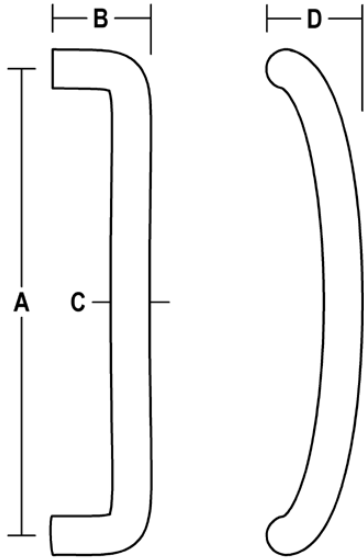

### D439 CURVED GRIP PULL

NO.	A	B	C	D
D439	12"	3"	Ø 1"	2.5"

**FEATURED FINISHES:** Flat Black (19), Satin Stainless (32D), Antimicrobial (AM)

**FINISHES:** Standard & Custom Available (See Pages 16 & 17)

**MATERIALS:** Aluminum, Brass, Bronze, Stainless Steel

**PRODUCT OPTIONS:** Custom Lengths Available

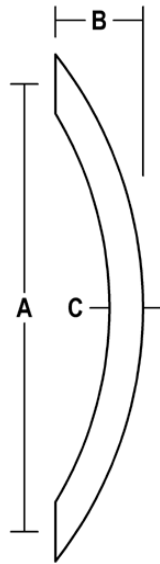

### D511 CURVED GRIP PULL

NO.	A	B	C
D511-1	12"	2.375"	Ø 0.75"
D511-2	12"	2.5"	Ø 1"

**FEATURED FINISHES:** Flat Black (19), Satin Stainless (32D), Antimicrobial (AM)

**FINISHES:** Standard & Custom Available (See Pages 16 & 17)

**MATERIALS:** Aluminum, Brass, Bronze, Stainless Steel



# ARCHITECTURAL DOOR PULLS

## MODERN CURVES

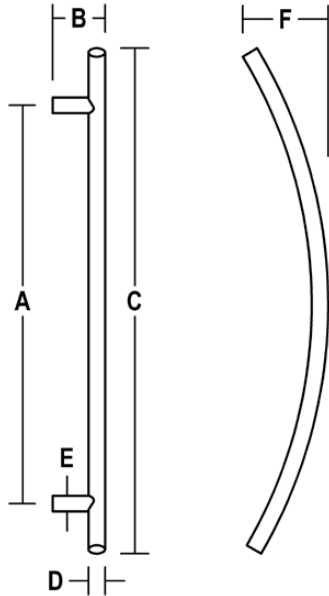

### D520 CURVED PULL

NO.	A	B	C	D	E	F
D520	18"	2.5"	24"	Ø 0.75"	Ø 0.75"	2.5"

**FEATURED FINISHES:** Flat Black (19), Satin Stainless (32D), Antimicrobial (AM)

**FINISHES:** Standard & Custom Available (See Pages 16 & 17)

**MATERIALS:** Aluminum, Brass, Bronze, Stainless Steel

**PRODUCT OPTIONS:** Custom Lengths Available

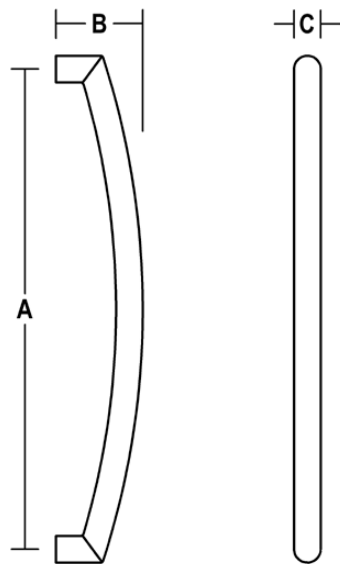

### D522 CURVED GRIP PULL W/ MITERED ENDS

NO.	A	B	C
D522	18"	3.25"	Ø 1"

**FEATURED FINISHES:** Flat Black (19), Satin Stainless (32D), Antimicrobial (AM)

**FINISHES:** Standard & Custom Available (See Pages 16 & 17)

**MATERIAL:** Stainless Steel

**PRODUCT OPTIONS:** Custom Lengths Available



# ARCHITECTURAL DOOR PULLS

## MODERN CURVES

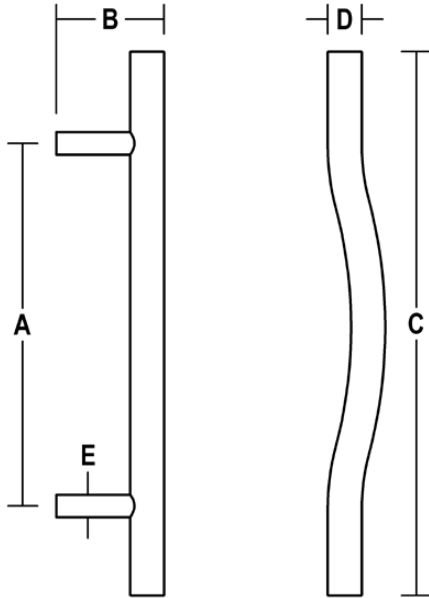

### D543 CURVED GRIP PULL

NO.	A	B	C	D	E
D543	8"	2.5"	12"	Ø 0.75"	Ø 0.75"

**FEATURED FINISHES:** Flat Black (19), Satin Stainless (32D), Antimicrobial (AM)

**FINISHES:** Standard & Custom Available (See Pages 16 & 17)

**MATERIALS:** Aluminum, Brass, Bronze, Stainless Steel

**PRODUCT OPTIONS:** Custom Lengths Available

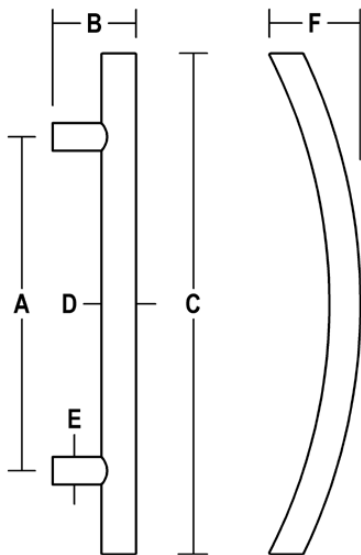

### D579 CURVED PULL - FLAT ENDS

NO.	A	B	C	D	E	F
D579	12"	3"	18"	Ø 1.25"	Ø 0.875"	3"

**FEATURED FINISHES:** Flat Black (19), Satin Stainless (32D), Antimicrobial (AM)

**FINISHES:** Standard & Custom Available (See Pages 16 & 17)

**MATERIALS:** Aluminum, Brass, Bronze, Stainless Steel

**PRODUCT OPTIONS:** Custom Lengths Available



# ARCHITECTURAL DOOR PULLS

## MODERN ANGLES

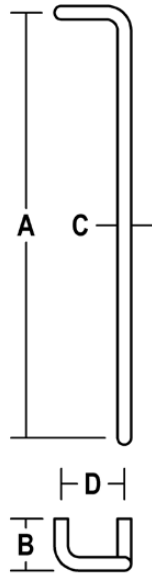

### D355

#### STRAIGHT PULL W/ SHORT L-GRIP - BENT ENDS

NO.	A	B	C	D
D355-1	42"	2.5"	Ø 0.75"	3"
D355-2	42"	3"	Ø 1"	3.5"
D355-3	42"	3.25"	Ø 1.25"	4"
D355-4	42"	3.5"	Ø 1.5"	4.5"

**FEATURED FINISHES:** Flat Black (19), Satin Stainless (32D), Antimicrobial (AM)

**FINISHES:** Standard & Custom Available (See Pages 16 & 17)

**MATERIALS:** Aluminum, Brass, Bronze, Stainless Steel

**PRODUCT OPTIONS:** Custom Lengths Available

**PRODUCT NOTES:** Handed Product (RH is shown)

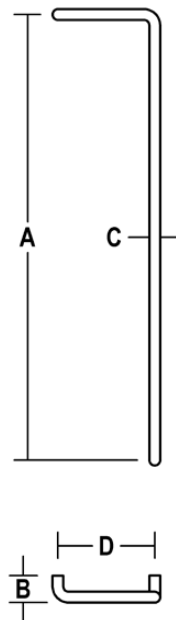

### D358

#### STRAIGHT PULL W/ LONG L-GRIP - BENT ENDS

NO.	A	B	C	D
D358-1	42"	2.5"	Ø 0.75"	8"
D358-2	42"	3"	Ø 1"	8"
D358-3	42"	3.25"	Ø 1.25"	8"
D358-4	42"	3.5"	Ø 1.5"	8"

**FEATURED FINISHES:** Flat Black (19), Satin Stainless (32D), Antimicrobial (AM)

**FINISHES:** Standard & Custom Available (See Pages 16 & 17)

**MATERIALS:** Aluminum, Brass, Bronze, Stainless Steel

**PRODUCT OPTIONS:** Custom Lengths Available

**PRODUCT NOTES:** Handed Product (RH is shown)



# ARCHITECTURAL DOOR PULLS

## MODERN ANGLES



### D360

#### L-SHAPE HORIZONTAL PUSH/PULL - UP BEND

NO.	A	B	C	D
D360-1	SPECIFY	2.5"	Ø 0.75"	9.5"
D360-2	SPECIFY	3"	Ø 1"	9.5"
D360-3	SPECIFY	3.25"	Ø 1.25"	9.5"
D360-4	SPECIFY	3.5"	Ø 1.5"	9.5"

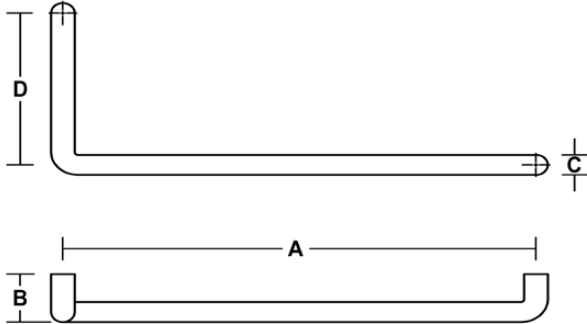

**FEATURED FINISHES:** Flat Black (19), Satin Stainless (32D), Antimicrobial (AM)

**FINISHES:** Standard & Custom Available (See Pages 16 & 17)

**MATERIALS:** Aluminum, Brass, Bronze, Stainless Steel

**PRODUCT NOTES:** Handed Product (RH is shown)



### D361

#### L-SHAPE HORIZONTAL PUSH/PULL - DOWN BEND

NO.	A	B	C	D
D361-1	SPECIFY	2.5"	Ø 0.75"	9.5"
D361-2	SPECIFY	3"	Ø 1"	9.5"
D361-3	SPECIFY	3.25"	Ø 1.25"	9.5"
D361-4	SPECIFY	3.5"	Ø 1.5"	9.5"

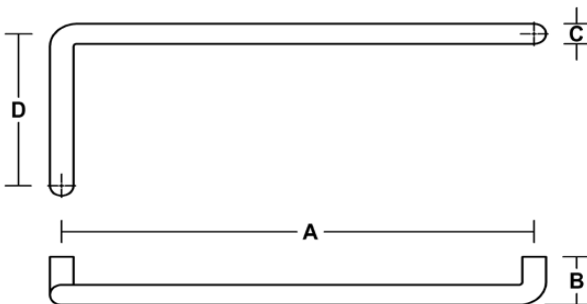

**FEATURED FINISHES:** Flat Black (19), Satin Stainless (32D), Antimicrobial (AM)

**FINISHES:** Standard & Custom Available (See Pages 16 & 17)

**MATERIALS:** Aluminum, Brass, Bronze, Stainless Steel

**PRODUCT NOTES:** Handed Product (RH is shown)



# ARCHITECTURAL DOOR PULLS

## MODERN ANGLES

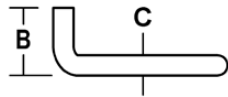
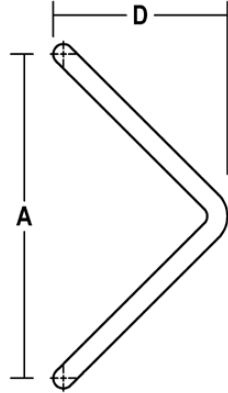

### D367

#### VERTICAL RIGHT ANGLE PULL - BENT ENDS

NO.	A	B	C	D
D367	12"	2.5"	Ø 0.75"	6.5"

**FEATURED FINISHES:** Flat Black (19), Satin Stainless (32D), Antimicrobial (AM)

**FINISHES:** Standard & Custom Available (See Pages 16 & 17)

**MATERIALS:** Aluminum, Brass, Bronze, Stainless Steel

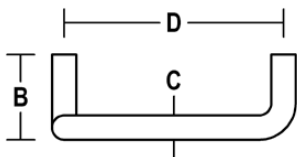
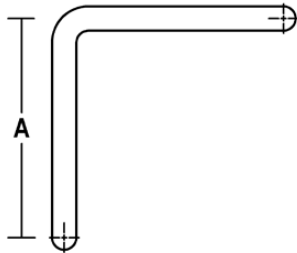
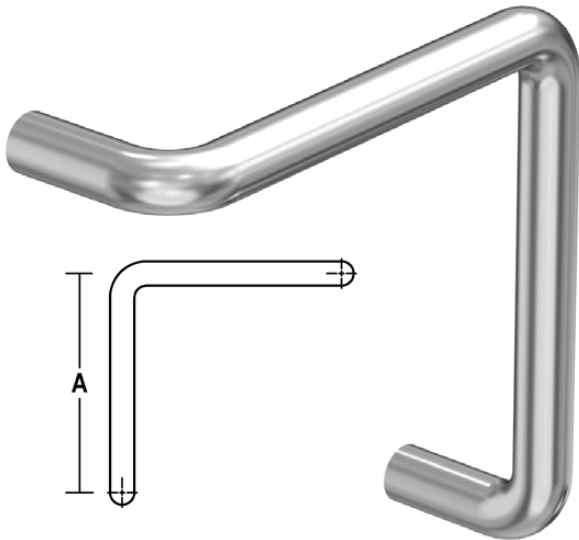

### D368

#### HORIZONTAL RIGHT ANGLE PULL - BENT ENDS

NO.	A	B	C	D
D368	9"	3"	Ø 1"	9"

**FEATURED FINISHES:** Flat Black (19), Satin Stainless (32D), Antimicrobial (AM)

**FINISHES:** Standard & Custom Available (See Pages 16 & 17)

**MATERIALS:** Aluminum, Brass, Bronze, Stainless Steel





# ARCHITECTURAL DOOR PULLS

## MODERN ANGLES

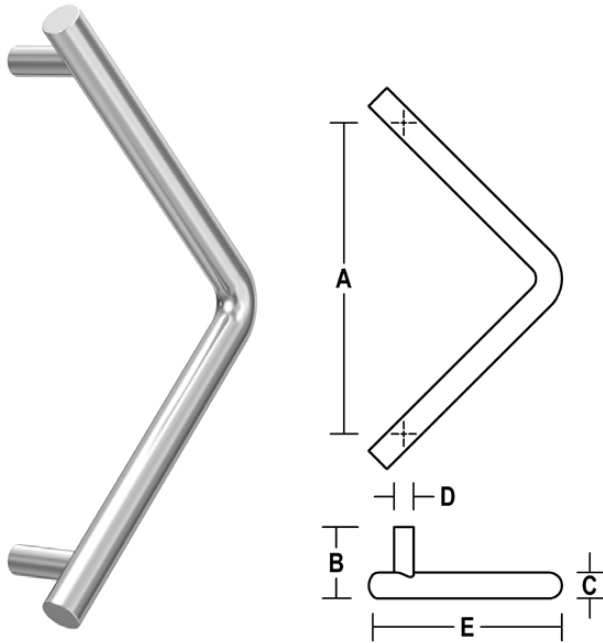

### D369

#### VERTICAL RIGHT ANGLE PULL W/ STANDARD POSTS - FLAT ENDS

NO.	A	B	C	D	E
D369	12"	2.75"	Ø 1"	Ø 0.75"	7.25"

**FEATURED FINISHES:** Flat Black (19), Satin Stainless (32D), Antimicrobial (AM)

**FINISHES:** Standard & Custom Available (See Pages 16 & 17)

**MATERIALS:** Aluminum, Brass, Bronze, Stainless Steel

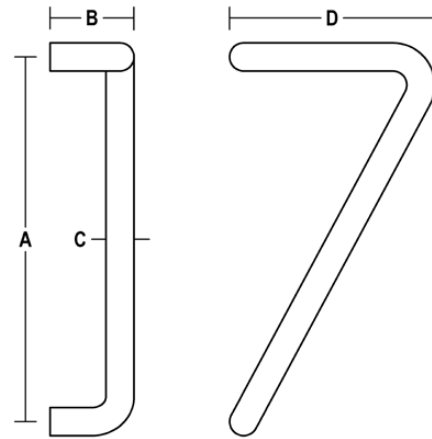
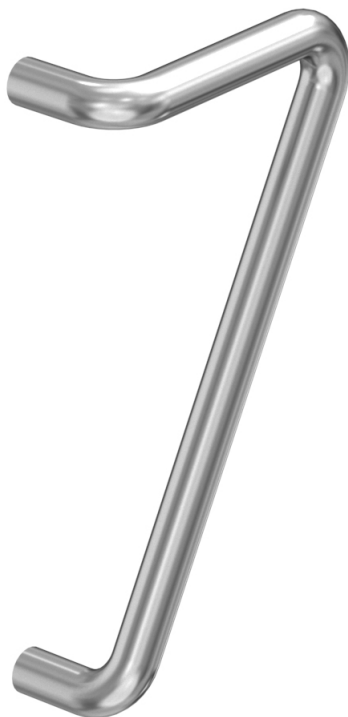

### D403

#### ANGLED GRIP PULL

NO.	A	B	C	D
D403	13"	3"	Ø 1"	7"

**FEATURED FINISHES:** Flat Black (19), Satin Stainless (32D), Antimicrobial (AM)

**FINISHES:** Standard & Custom Available (See Pages 16 & 17)

**MATERIALS:** Aluminum, Brass, Bronze, Stainless Steel

**PRODUCT NOTES:** Handed Product (RH is shown)



# ARCHITECTURAL DOOR PULLS

## MODERN ANGLES

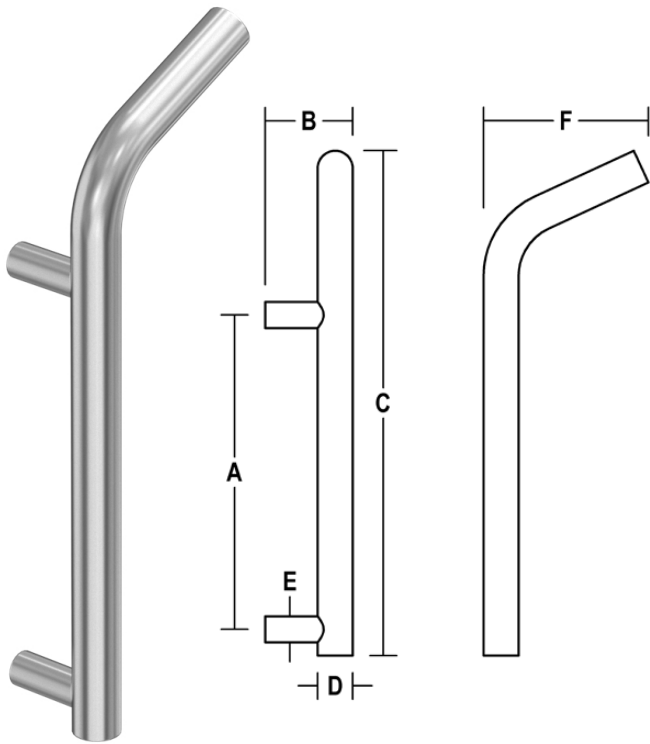

### D515 ANGLED GRIP PULL

NO.	A	B	C	D	E	F
D515	9"	2.75"	14.5"	Ø 1"	Ø 0.75"	4.5"

**FEATURED FINISHES:** Flat Black (19), Satin Stainless (32D), Antimicrobial (AM)

**FINISHES:** Standard & Custom Available (See Pages 16 & 17)

**MATERIALS:** Aluminum, Brass, Bronze, Stainless Steel

**PRODUCT OPTIONS:** Custom Lengths Available

**PRODUCT NOTES:** Handed Product (RH is shown)

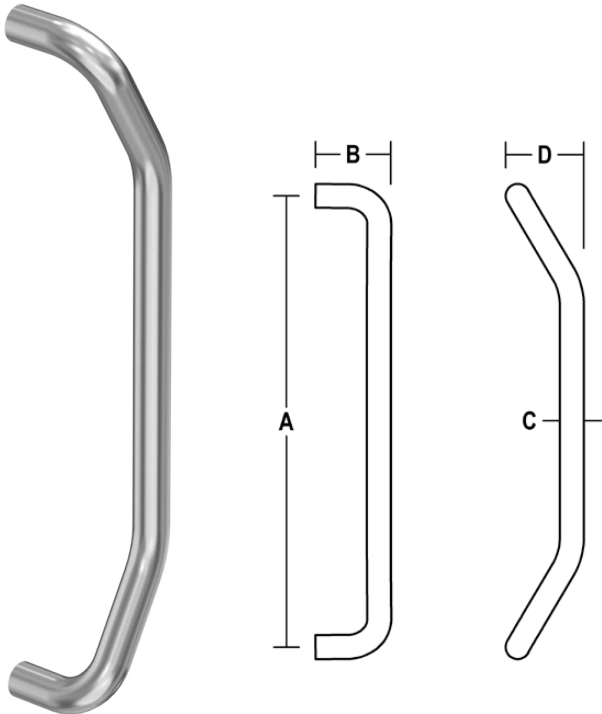

### D538 OFFSET ANGLED PULL

NO.	A	B	C	D
D538	15"	2.5"	Ø 0.75"	2.5"

**FEATURED FINISHES:** Flat Black (19), Satin Stainless (32D), Antimicrobial (AM)

**FINISHES:** Standard & Custom Available (See Pages 16 & 17)

**MATERIALS:** Aluminum, Brass, Bronze, Stainless Steel

**PRODUCT OPTIONS:** Custom Lengths Available



# ARCHITECTURAL DOOR PULLS

## MODERN FLAT

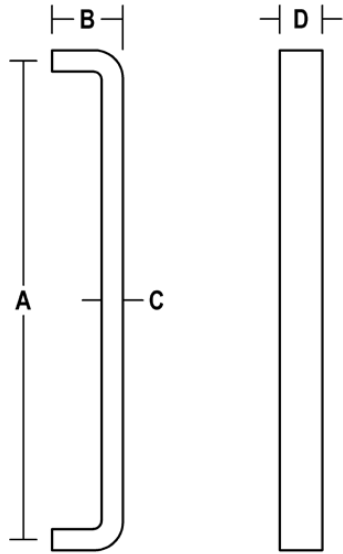

### D376 FLAT GRIP PULL - BENT ENDS

NO.	A	B	C	D
D376-1	12"	2.5"	0.5"	1.25"
D376-2	18"	2.5"	0.75"	1.5"

**FEATURED FINISHES:** Flat Black (19), Satin Stainless (32D), Antimicrobial (AM)

**FINISHES:** Standard & Custom Available (See Pages 16 & 17)

**MATERIALS:** Aluminum, Brass, Bronze, Stainless Steel

**PRODUCT OPTIONS:** Custom Lengths Available

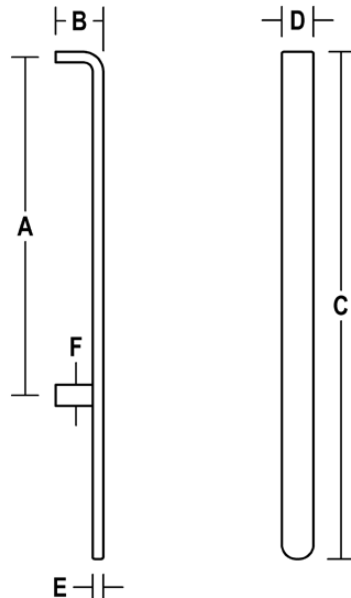
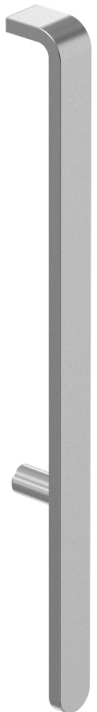

### D380 FLAT GRIP PULL - ROUND END

NO.	A	B	C	D	E	F
D380	16"	2.25"	24"	1.5"	0.5"	Ø 1"

**FEATURED FINISHES:** Flat Black (19), Satin Stainless (32D), Antimicrobial (AM)

**FINISHES:** Standard & Custom Available (See Pages 16 & 17)

**MATERIALS:** Aluminum, Brass, Bronze, Stainless Steel

**PRODUCT OPTIONS:** Custom Lengths Available



# ARCHITECTURAL DOOR PULLS

## MODERN FLAT

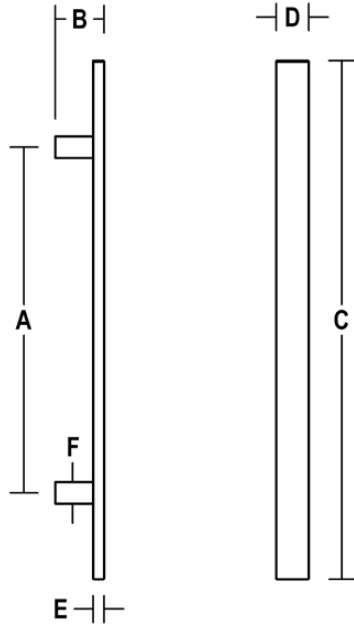

### D381

#### FLAT GRIP PULL - FLAT ENDS

NO.	A	B	C	D	E	F
D381	16"	2.25"	24"	1.5"	0.5"	Ø 1"

**FEATURED FINISHES:** Flat Black (19), Satin Stainless (32D), Antimicrobial (AM)

**FINISHES:** Standard & Custom Available (See Pages 16 & 17)

**MATERIALS:** Aluminum, Brass, Bronze, Stainless Steel

**PRODUCT OPTIONS:** Custom Lengths Available

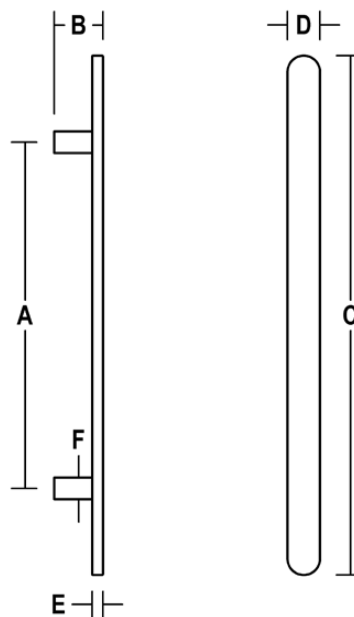
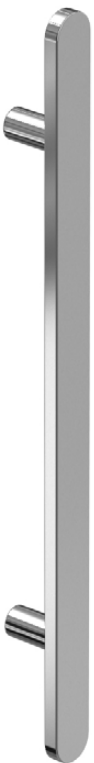

### D382

#### FLAT GRIP PULL - ROUND ENDS

NO.	A	B	C	D	E	F
D382	16"	2.25"	24"	1.5"	0.5"	Ø 1"

**FEATURED FINISHES:** Flat Black (19), Satin Stainless (32D), Antimicrobial (AM)

**FINISHES:** Standard & Custom Available (See Pages 16 & 17)

**MATERIALS:** Aluminum, Brass, Bronze, Stainless Steel

**PRODUCT OPTIONS:** Custom Lengths Available



# ARCHITECTURAL DOOR PULLS

## MODERN FLAT

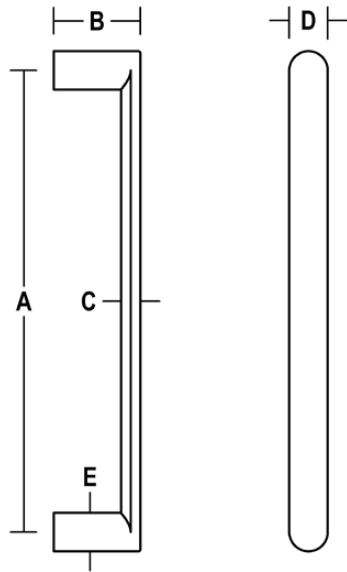

### D383

#### HALF-ROUND FLAT GRIP PULL

NO.	A	B	C	D	E
D383	12"	2.25"	0.5"	1"	Ø 1"

**FEATURED FINISHES:** Flat Black (19), Satin Stainless (32D), Antimicrobial (AM)

**FINISHES:** Standard & Custom Available (See Pages 16 & 17)

**MATERIALS:** Stainless Steel

**PRODUCT OPTIONS:** Custom Lengths Available

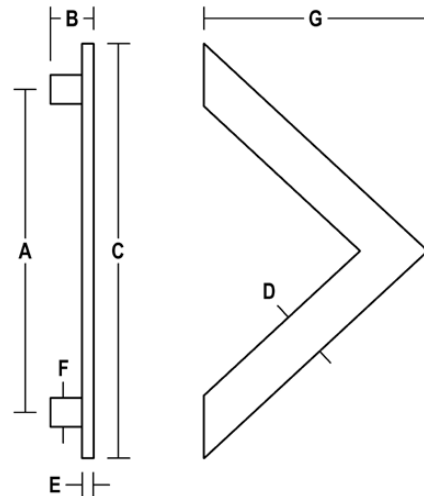
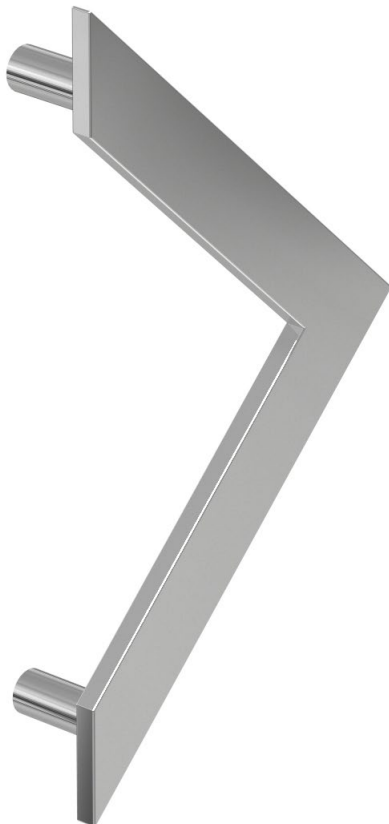

### D388

#### RIGHT ANGLE FLAT GRIP PULL

NO.	A	B	C	D	E	F	G
D388	14"	2.25"	18.25"	2"	0.5"	Ø 1"	9.625"

**FEATURED FINISHES:** Flat Black (19), Satin Stainless (32D), Antimicrobial (AM)

**FINISHES:** Standard & Custom Available (See Pages 16 & 17)

**MATERIALS:** Aluminum, Brass, Bronze, Stainless Steel



# ARCHITECTURAL DOOR PULLS

## MODERN FLAT

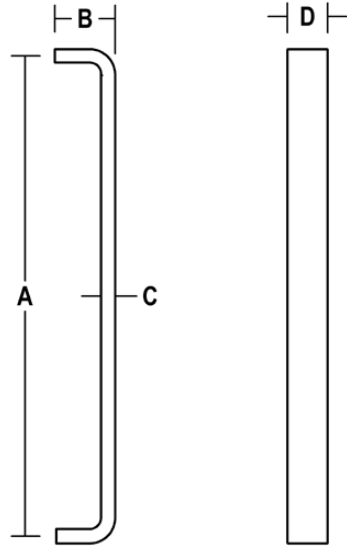
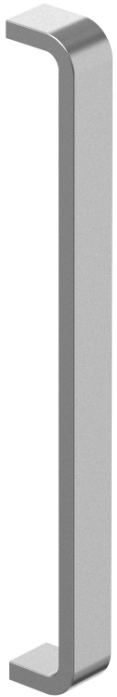

### D396

#### ROUNDED FLAT GRIP PULL

NO.	A	B	C	D
D396	18"	2.25"	0.5"	1.5"

**FEATURED FINISHES:** Flat Black (19), Satin Stainless (32D), Antimicrobial (AM)

**FINISHES:** Standard & Custom Available (See Pages 16 & 17)

**MATERIALS:** Aluminum, Brass, Bronze, Stainless Steel

**PRODUCT OPTIONS:** Custom Lengths Available

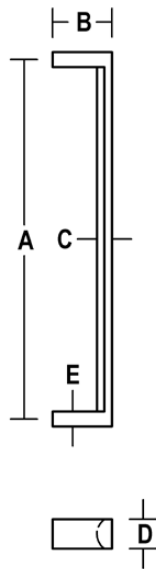

### D397

#### FLAT PULL W/ HALF-ROUND GRIP

NO.	A	B	C	D	E
D397	12"	2"	0.5"	1"	0.5"

**FEATURED FINISHES:** Flat Black (19), Satin Stainless (32D), Antimicrobial (AM)

**FINISHES:** Standard & Custom Available (See Pages 16 & 17)

**MATERIAL:** Stainless Steel

**PRODUCT OPTIONS:** Custom Lengths Available



# ARCHITECTURAL DOOR PULLS

## MODERN FLAT

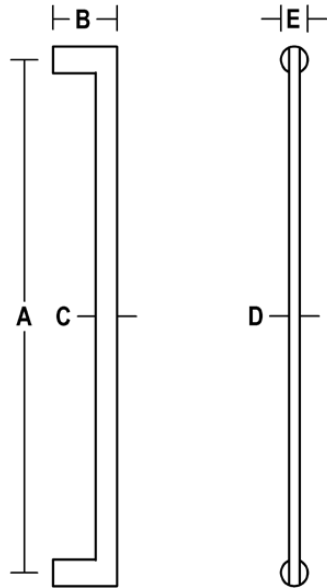

### D402 FLAT GRIP PULL W/ ROUND BASE

NO.	A	B	C	D	E
D402	24"	3"	1"	0.5"	Ø 1.25"

**FEATURED FINISHES:** Flat Black (19), Satin Stainless (32D), Antimicrobial (AM)

**FINISHES:** Standard & Custom Available (See Pages 16 & 17)

**MATERIALS:** Aluminum, Brass, Bronze, Stainless Steel

**PRODUCT OPTIONS:** Custom Lengths Available

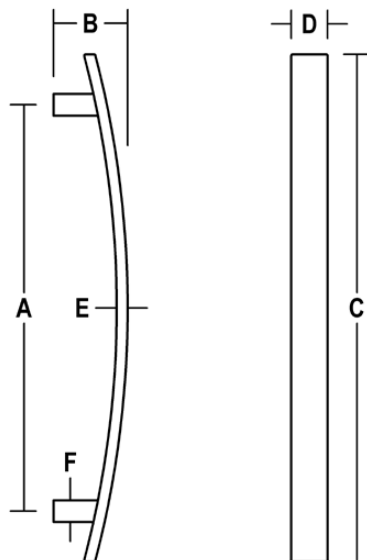

### D526 FLAT PULL W/ CURVE

NO.	A	B	C	D	E	F
D526	14"	2"	18"	1.25"	0.375"	Ø 0.75"

**FEATURED FINISHES:** Flat Black (19), Satin Stainless (32D), Antimicrobial (AM)

**FINISHES:** Standard & Custom Available (See Pages 16 & 17)

**MATERIALS:** Aluminum, Brass, Bronze, Stainless Steel

**PRODUCT OPTIONS:** Custom Lengths Available



# ARCHITECTURAL DOOR PULLS

## MODERN FLAT

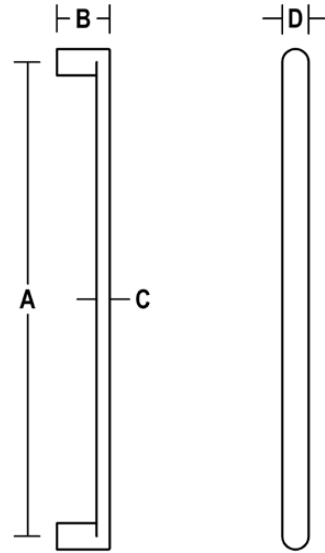

### D527 FLAT PULL

NO.	A	B	C	D
D527	18"	2"	0.5"	1"

**FEATURED FINISHES:** Flat Black (19), Satin Stainless (32D), Antimicrobial (AM)

**FINISHES:** Standard & Custom Available (See Pages 16 & 17)

**MATERIALS:** Aluminum, Brass, Bronze, Stainless Steel

**PRODUCT OPTIONS:** Custom Lengths Available





# ARCHITECTURAL DOOR PULLS

## MODERN RECTANGULAR

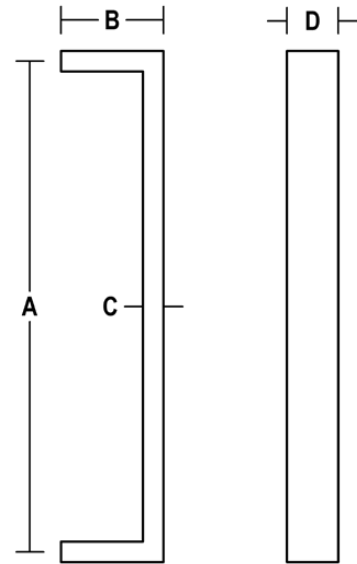
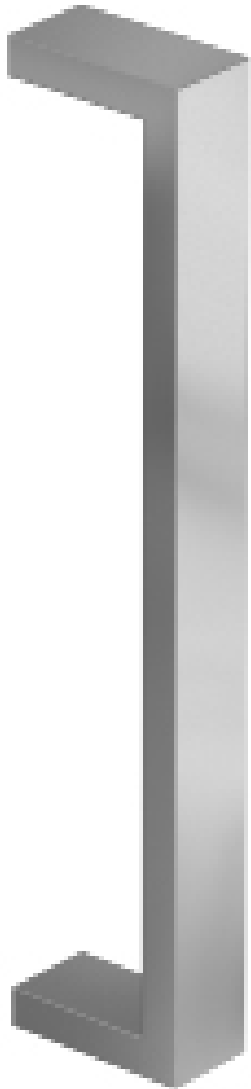

### D595

#### SLIM RECTANGULAR PULL - MITERED ENDS

NO.	A	B	C	D
D595-1	12"	2.5"	0.5"	1.25"
D595-2	18"	2.5"	0.75"	1.5"

**FEATURED FINISHES:** Flat Black (19), Satin Stainless (32D),  
Antimicrobial (AM)

**FINISHES:** Standard & Custom Available (See Pages 16 & 17)

**MATERIALS:** Stainless Steel

**PRODUCT OPTIONS:** Custom Lengths Available



# ARCHITECTURAL DOOR PULLS

## MODERN RECTANGULAR

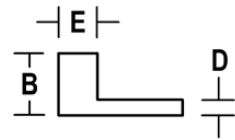
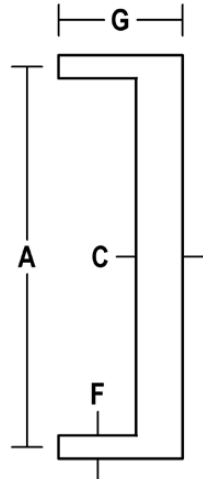

### D384 OFFSET RECTANGULAR PULL

NO.	A	B	C	D	E	F	G
D384	12"	2"	1.5"	0.5"	1.5"	1"	4"

**FEATURED FINISHES:** Flat Black (19), Satin Stainless (32D), Antimicrobial (AM)

**FINISHES:** Standard & Custom Available (See Pages 16 & 17)

**MATERIAL:** Stainless Steel

**PRODUCT OPTIONS:** Custom Lengths Available

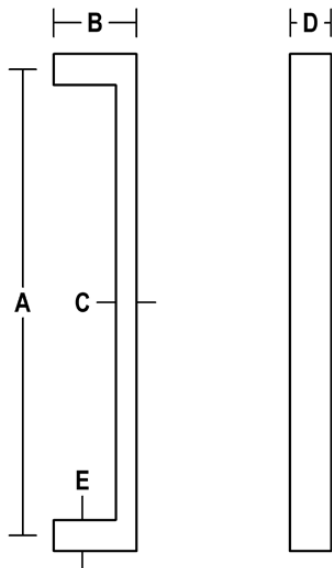

### D386 RECTANGULAR PULL

NO.	A	B	C	D	E
D386	12"	2"	0.5"	1"	1"

**FEATURED FINISHES:** Flat Black (19), Satin Stainless (32D), Antimicrobial (AM)

**FINISHES:** Standard & Custom Available (See Pages 16 & 17)

**MATERIAL:** Stainless Steel

**PRODUCT OPTIONS:** Custom Lengths Available



# ARCHITECTURAL DOOR PULLS

## MODERN RECTANGULAR

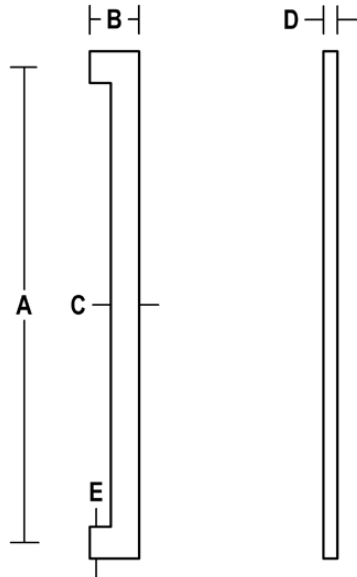

### D387 RECTANGULAR PULL

NO.	A	B	C	D	E
D387	34"	3.5"	2"	1"	2"

**FEATURED FINISHES:** Flat Black (19), Satin Stainless (32D), Antimicrobial (AM)

**FINISHES:** Standard & Custom Available (See Pages 16 & 17)

**MATERIAL:** Stainless Steel

**PRODUCT OPTIONS:** Custom Lengths Available

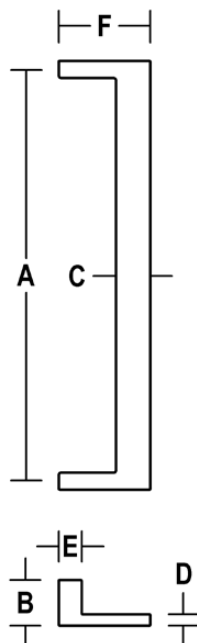

### D523 OFFSET RECTANGULAR PULL

NO.	A	B	C	D	E	F
D523	18"	2"	1.5"	0.5"	1.25"	4"

**FEATURED FINISHES:** Flat Black (19), Satin Stainless (32D), Antimicrobial (AM)

**FINISHES:** Standard & Custom Available (See Pages 16 & 17)

**MATERIAL:** Stainless Steel

**PRODUCT OPTIONS:** Custom Lengths Available



# ARCHITECTURAL DOOR PULLS

## MODERN SQUARE

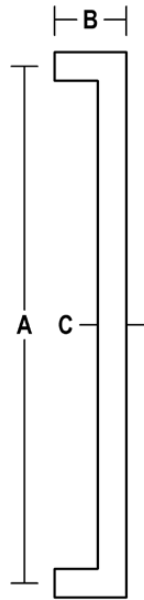
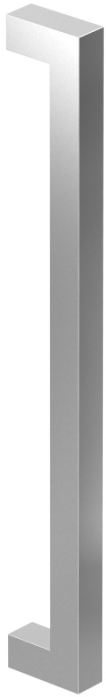

### D401

#### SQUARE GRIP STRAIGHT PULL

NO.	A	B	C
D401-1	18"	2.5"	□ 0.75"
D401-2	18"	2.75"	□ 1"

**FEATURED FINISHES:** Flat Black (19), Satin Stainless (32D), Antimicrobial (AM)

**FINISHES:** Standard & Custom Available (See Pages 16 & 17)

**MATERIAL:** Stainless Steel

**PRODUCT OPTIONS:** Custom Lengths Available

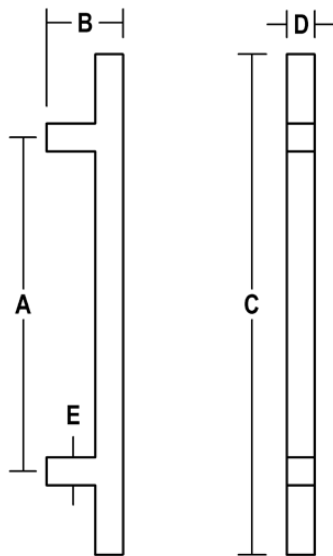
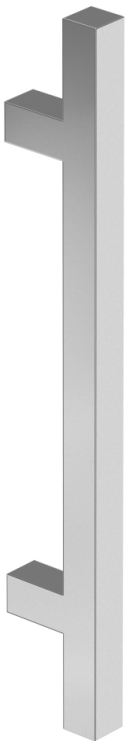

### D432

#### SQUARE GRIP PULL

NO.	A	B	C	D	E
D432-1	12"	2.5"	18"	□ 0.75"	□ 0.75"
D432-2	12"	2.75"	18"	□ 1"	□ 1"

**FEATURED FINISHES:** Flat Black (19), Satin Stainless (32D), Antimicrobial (AM)

**FINISHES:** Standard & Custom Available (See Pages 16 & 17)

**MATERIALS:** Aluminum, Brass, Bronze, Stainless Steel

**PRODUCT OPTIONS:** Custom Lengths Available



# ARCHITECTURAL DOOR PULLS

## MODERN SQUARE

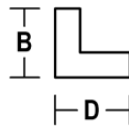
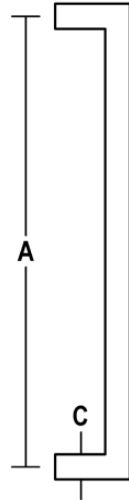

### D541

#### SQUARE OFFSET PULL W/ MITERED ENDS

NO.	A	B	C	D
D541-1	18"	2.5"	□ 0.75"	3"
D541-2	18"	2.75"	□ 1"	3"

**FEATURED FINISHES:** Flat Black (19), Satin Stainless (32D),  
Antimicrobial (AM)

**FINISHES:** Standard & Custom Available (See Pages 16 & 17)

**MATERIAL:** Stainless Steel

**PRODUCT OPTIONS:** Custom Lengths Available

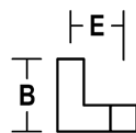
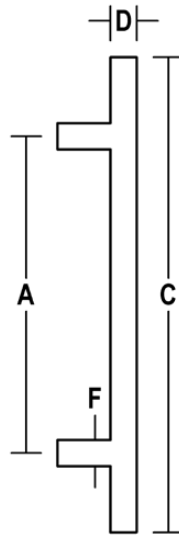

### D434

#### SQUARE GRIP OFFSET PULL

NO.	A	B	C	D	E	F
D434-1	12"	2.5"	18"	□ 0.75"	2"	□ 0.75"
D434-2	12"	2.75"	18"	□ 1"	2"	□ 1"

**FEATURED FINISHES:** Flat Black (19), Satin Stainless (32D),  
Antimicrobial (AM)

**FINISHES:** Standard & Custom Available (See Pages 16 & 17)

**MATERIALS:** Stainless Steel

**PRODUCT OPTIONS:** Custom Lengths Available



# ARCHITECTURAL DOOR PULLS

## WOOD

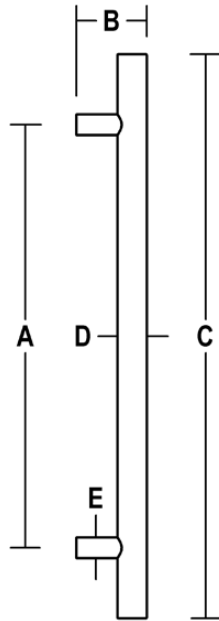

### D600

#### WOOD PULL W/ STANDARD POSTS - FLAT ENDS

NO.	A	B	C	D	E
D600-2	SPECIFY	2.75"	SPECIFY	Ø 1"	Ø 0.75"
D600-3	SPECIFY	3"	SPECIFY	Ø 1.25"	Ø 0.875"
D600-4	SPECIFY	3.25"	SPECIFY	Ø 1.5"	Ø 0.875"

**FEATURED FINISHES:** Flat Black (19), Satin Stainless (32D)

**FINISHES:** Standard & Custom Available (See Pages 16 & 17)

**MATERIALS:** Aluminum, Brass, Bronze, Stainless Steel, Wood

**WOOD SPECIES:** Red Oak, White Oak, Maple, Walnut, Hickory, Poplar (Other species available upon request)

**PRODUCT OPTIONS:** Custom Lengths Available

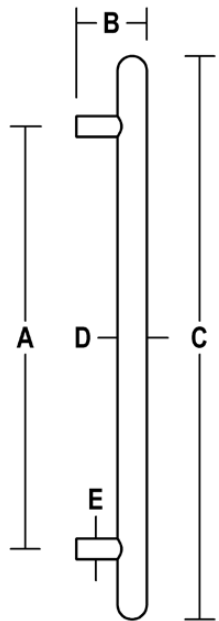

### D601

#### WOOD PULL W/ STANDARD POSTS - ROUND ENDS

NO.	A	B	C	D	E
D601-2	SPECIFY	2.75"	SPECIFY	Ø 1"	Ø 0.75"
D601-3	SPECIFY	3"	SPECIFY	Ø 1.25"	Ø 0.875"
D601-4	SPECIFY	3.25"	SPECIFY	Ø 1.5"	Ø 0.875"

**FEATURED FINISHES:** Flat Black (19), Satin Stainless (32D)

**FINISHES:** Standard & Custom Available (See Pages 16 & 17)

**MATERIALS:** Aluminum, Brass, Bronze, Stainless Steel, Wood

**WOOD SPECIES:** Red Oak, White Oak, Maple, Walnut, Hickory, Poplar (Other species available upon request)

**PRODUCT OPTIONS:** Custom Lengths Available



# ARCHITECTURAL DOOR PULLS

## WOOD

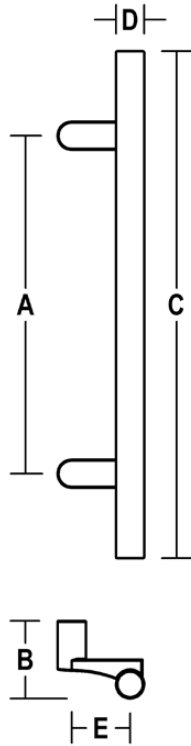

### D602

#### WOOD PULL W/ OFFSET H POSTS - FLAT ENDS

NO.	A	B	C	D	E
D602-2	SPECIFY	2.75"	SPECIFY	Ø 1"	2"
D602-3	SPECIFY	3"	SPECIFY	Ø 1.25"	2"
D602-4	SPECIFY	3.25"	SPECIFY	Ø 1.5"	2"

**FEATURED FINISHES:** Flat Black (19), Satin Stainless (32D)

**FINISHES:** Standard & Custom Available (See Pages 16 & 17)

**MATERIALS:** Aluminum, Brass, Bronze, Stainless Steel, Wood

**WOOD SPECIES:** Red Oak, White Oak, Maple, Walnut, Hickory, Poplar (Other species available upon request)

**PRODUCT OPTIONS:** Custom Lengths Available

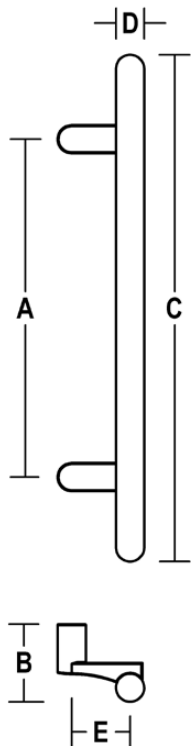

### D603

#### WOOD PULL W/ OFFSET H POSTS - ROUND ENDS

NO.	A	B	C	D	E
D603-2	SPECIFY	2.75"	SPECIFY	Ø 1"	2"
D603-3	SPECIFY	3"	SPECIFY	Ø 1.25"	2"
D603-4	SPECIFY	3.25"	SPECIFY	Ø 1.5"	2"

**FEATURED FINISHES:** Flat Black (19), Satin Stainless (32D)

**FINISHES:** Standard & Custom Available (See Pages 16 & 17)

**MATERIALS:** Aluminum, Brass, Bronze, Stainless Steel, Wood

**WOOD SPECIES:** Red Oak, White Oak, Maple, Walnut, Hickory, Poplar (Other species available upon request)

**PRODUCT OPTIONS:** Custom Lengths Available



# ARCHITECTURAL DOOR PULLS

## WOOD

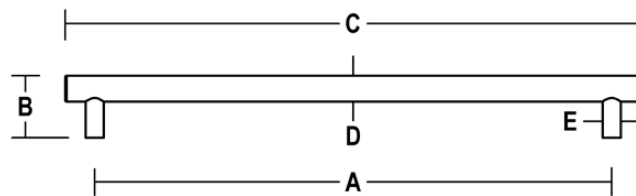

### D604

#### WOOD PUSH BAR - FLAT ENDS

NO.	A	B	C	D	E
D604-2	SPECIFY 2.75"	SPECIFY	SPECIFY	Ø 1"	Ø 0.75"
D604-3	SPECIFY 3"	SPECIFY	SPECIFY	Ø 1.25"	Ø 0.875"
D604-4	SPECIFY 3.25"	SPECIFY	SPECIFY	Ø 1.5"	Ø 0.875"

**FEATURED FINISHES:** Flat Black (19), Satin Stainless (32D)

**FINISHES:** Standard & Custom Available (See Pages 16 & 17)

**MATERIALS:** Aluminum, Brass, Bronze, Stainless Steel, Wood

**WOOD SPECIES:** Red Oak, White Oak, Maple, Walnut, Hickory, Poplar (Other species available upon request)

**PRODUCT OPTIONS:** Custom Lengths Available





# ARCHITECTURAL DOOR PULLS

## WOOD

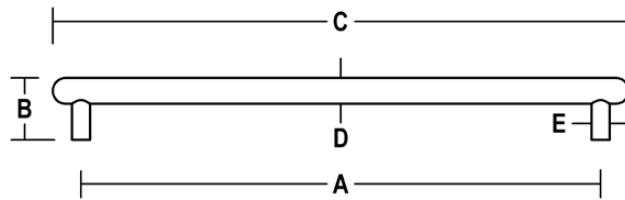

### D605

#### WOOD PUSH BAR - ROUND ENDS

NO.	A	B	C	D	E
D605-2	SPECIFY 2.75"	SPECIFY	SPECIFY	Ø 1"	Ø 0.75"
D605-3	SPECIFY 3"	SPECIFY	SPECIFY	Ø 1.25"	Ø 0.875"
D605-4	SPECIFY 3.25"	SPECIFY	SPECIFY	Ø 1.5"	Ø 0.875"

**FEATURED FINISHES:** Flat Black (19), Satin Stainless (32D)

**FINISHES:** Standard & Custom Available (See Pages 16 & 17)

**MATERIALS:** Aluminum, Brass, Bronze, Stainless Steel, Wood

**WOOD SPECIES:** Red Oak, White Oak, Maple, Walnut, Hickory, Poplar (Other species available upon request)

**PRODUCT OPTIONS:** Custom Lengths Available



# ARCHITECTURAL DOOR PULLS

## WOOD

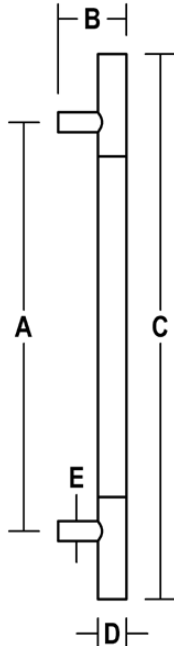

### D610

#### WOOD GRIP PULL W/ STANDARD POSTS - FLAT ENDS

NO.	A	B	C	D	E
D610-2	SPECIFY 2.75"	SPECIFY	Ø 1"	Ø 0.75"	
D610-3	SPECIFY 3"	SPECIFY	Ø 1.25"	Ø 0.875"	
D610-4	SPECIFY 3.25"	SPECIFY	Ø 1.5"	Ø 0.875"	

**FEATURED FINISHES:** Flat Black (19), Satin Stainless (32D)

**FINISHES:** Standard & Custom Available (See Pages 16 & 17)

**MATERIALS:** Aluminum, Brass, Bronze, Stainless Steel, Wood

**WOOD SPECIES:** Red Oak, White Oak, Maple, Walnut, Hickory, Poplar (Other species available upon request)

**PRODUCT OPTIONS:** Custom Lengths Available

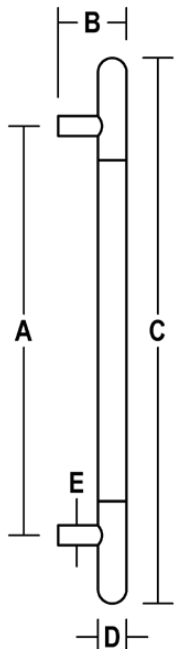

### D611

#### WOOD GRIP PULL W/ STANDARD POSTS - ROUND ENDS

NO.	A	B	C	D	E
D611-2	SPECIFY 2.75"	SPECIFY	Ø 1"	Ø 0.75"	
D611-3	SPECIFY 3"	SPECIFY	Ø 1.25"	Ø 0.875"	
D611-4	SPECIFY 3.25"	SPECIFY	Ø 1.5"	Ø 0.875"	

**FEATURED FINISHES:** Flat Black (19), Satin Stainless (32D)

**FINISHES:** Standard & Custom Available (See Pages 16 & 17)

**MATERIALS:** Aluminum, Brass, Bronze, Stainless Steel, Wood

**WOOD SPECIES:** Red Oak, White Oak, Maple, Walnut, Hickory, Poplar (Other species available upon request)

**PRODUCT OPTIONS:** Custom Lengths Available



# ARCHITECTURAL DOOR PULLS

## WOOD

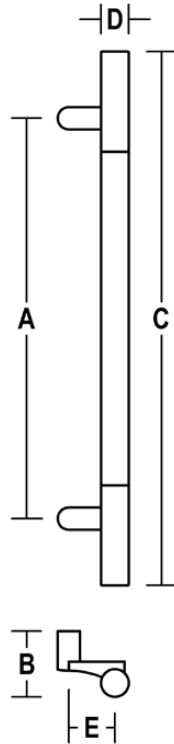

### D612

#### WOOD GRIP PULL W/ OFFSET H POSTS - FLAT ENDS

NO.	A	B	C	D	E
D612-2	SPECIFY	2.75"	SPECIFY	Ø 1"	2"
D612-3	SPECIFY	3"	SPECIFY	Ø 1.25"	2"
D612-4	SPECIFY	3.25"	SPECIFY	Ø 1.5"	2"

**FEATURED FINISHES:** Flat Black (19), Satin Stainless (32D),

**FINISHES:** Standard & Custom Available (See Pages 16 & 17)

**MATERIALS:** Aluminum, Brass, Bronze, Stainless Steel, Wood

**WOOD SPECIES:** Red Oak, White Oak, Maple, Walnut, Hickory, Poplar (Other species available upon request)

**PRODUCT OPTIONS:** Custom Lengths Available

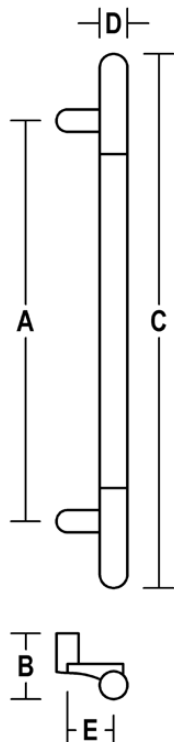

### D613

#### WOOD GRIP PULL W/ OFFSET H POSTS - ROUND ENDS

NO.	A	B	C	D	E
D613-2	SPECIFY	2.75"	SPECIFY	Ø 1"	2"
D613-3	SPECIFY	3"	SPECIFY	Ø 1.25"	2"
D613-4	SPECIFY	3.25"	SPECIFY	Ø 1.5"	2"

**FEATURED FINISHES:** Flat Black (19), Satin Stainless (32D)

**FINISHES:** Standard & Custom Available (See Pages 16 & 17)

**MATERIALS:** Aluminum, Brass, Bronze, Stainless Steel, Wood

**WOOD SPECIES:** Red Oak, White Oak, Maple, Walnut, Hickory, Poplar (Other species available upon request)

**PRODUCT OPTIONS:** Custom Lengths Available



# ARCHITECTURAL DOOR PULLS

## WOOD

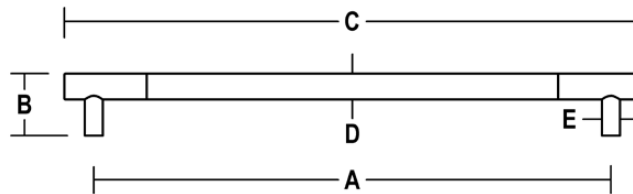

### D614

#### WOOD GRIP PUSH BAR - FLAT ENDS

NO.	A	B	C	D	E
D614-2	SPECIFY	2.75"	SPECIFY	Ø 1"	Ø 0.75"
D613-3	SPECIFY	3"	SPECIFY	Ø 1.25"	Ø 0.875"
D614-4	SPECIFY	3.25"	SPECIFY	Ø 1.5"	Ø 0.875"

**FEATURED FINISHES:** Flat Black (19), Satin Stainless (32D)

**FINISHES:** Standard & Custom Available (See Pages 16 & 17)

**MATERIALS:** Aluminum, Brass, Bronze, Stainless Steel, Wood

**WOOD SPECIES:** Red Oak, White Oak, Maple, Walnut, Hickory, Poplar (Other species available upon request)

**PRODUCT OPTIONS:** Custom Lengths Available



# ARCHITECTURAL DOOR PULLS

## WOOD

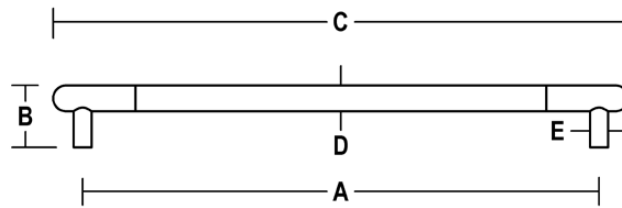

### D615

#### WOOD GRIP PUSH BAR - ROUND ENDS

NO.	A	B	C	D	E
D615-2	SPECIFY	2.75"	SPECIFY	Ø 1"	Ø 0.75"
D615-3	SPECIFY	3"	SPECIFY	Ø 1.25"	Ø 0.875"
D615-4	SPECIFY	3.25"	SPECIFY	Ø 1.5"	Ø 0.875"

**FEATURED FINISHES:** Flat Black (19), Satin Stainless (32D)

**FINISHES:** Standard & Custom Available (See Pages 16 & 17)

**MATERIALS:** Aluminum, Brass, Bronze, Stainless Steel, Wood

**WOOD SPECIES:** Red Oak, White Oak, Maple, Walnut, Hickory, Poplar (Other species available upon request)

**PRODUCT OPTIONS:** Custom Lengths Available



# ARCHITECTURAL DOOR PULLS

## LEATHER

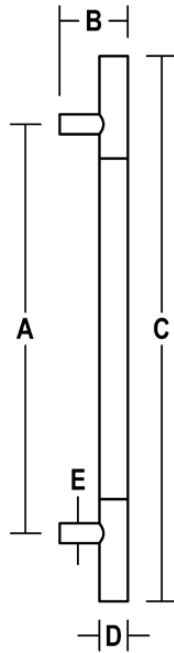

### D620

#### LEATHER WRAP PULL W/ STANDARD POSTS - FLAT ENDS

NO.	A	B	C	D	E
D620	SPECIFY	3"	SPECIFY	Ø 1.25"	Ø 0.875"

**FEATURED FINISHES:** Flat Black (19), Satin Stainless (32D)

**FINISHES:** Standard & Custom Available (See Pages 16 & 17)

**MATERIALS:** Aluminum, Brass, Bronze, Stainless Steel, Leather

**PRODUCT OPTIONS:** Custom Lengths Available

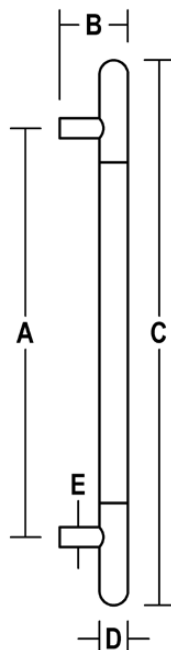

### D621

#### LEATHER WRAP PULL W/ STANDARD POSTS - ROUND ENDS

NO.	A	B	C	D	E
D621	SPECIFY	3"	SPECIFY	Ø 1.25"	Ø 0.875"

**FEATURED FINISHES:** Flat Black (19), Satin Stainless (32D)

**FINISHES:** Standard & Custom Available (See Pages 16 & 17)

**MATERIALS:** Aluminum, Brass, Bronze, Stainless Steel, Leather

**PRODUCT OPTIONS:** Custom Lengths Available



# ARCHITECTURAL DOOR PULLS

## LEATHER

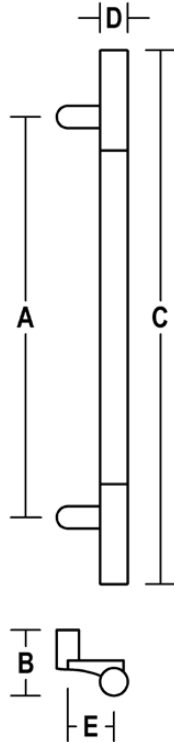

### D622

#### LEATHER WRAP PULL W/ OFFSET H POSTS - FLAT ENDS

NO.	A	B	C	D	E
D622	SPECIFY	3"	SPECIFY	Ø 1.25"	2"

**FEATURED FINISHES:** Flat Black (19), Satin Stainless (32D)

**FINISHES:** Standard & Custom Available (See Pages 16 & 17)

**MATERIALS:** Aluminum, Brass, Bronze, Stainless Steel, Leather

**PRODUCT OPTIONS:** Custom Lengths Available

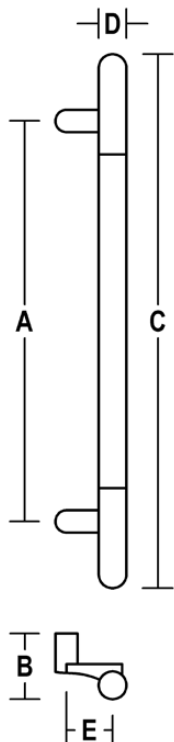

### D623

#### LEATHER WRAP PULL W/ OFFSET H POSTS - ROUND ENDS

NO.	A	B	C	D	E
D623	SPECIFY	3"	SPECIFY	Ø 1.25"	2"

**FEATURED FINISHES:** Flat Black (19), Satin Stainless (32D)

**FINISHES:** Standard & Custom Available (See Pages 16 & 17)

**MATERIALS:** Aluminum, Brass, Bronze, Stainless Steel, Leather

**PRODUCT OPTIONS:** Custom Lengths Available



# ARCHITECTURAL DOOR PULLS

## LEATHER

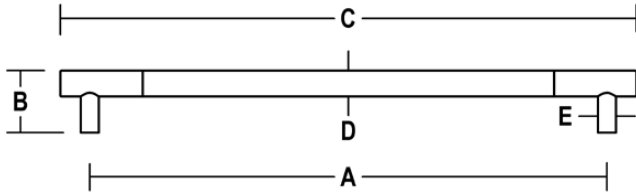

### D624

#### LEATHER WRAP PUSH BAR - FLAT ENDS

NO.	A	B	C	D	E
D624	SPECIFY	3"	SPECIFY	Ø 1.25"	Ø 0.875"

**FEATURED FINISHES:** Flat Black (19), Satin Stainless (32D)

**FINISHES:** Standard & Custom Available (See Pages 16 & 17)

**MATERIALS:** Aluminum, Brass, Bronze, Stainless Steel, Leather

**PRODUCT OPTIONS:** Custom Lengths Available

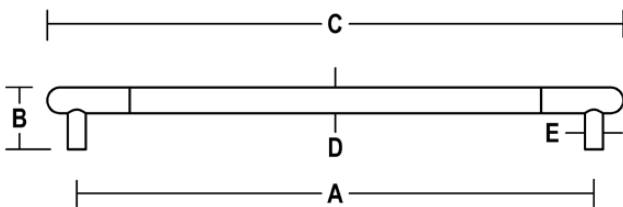

### D625

#### LEATHER WRAP PUSH BAR - ROUND ENDS

NO.	A	B	C	D	E
D625	SPECIFY	3"	SPECIFY	Ø 1.25"	Ø 0.875"

**FEATURED FINISHES:** Flat Black (19), Satin Stainless (32D)

**FINISHES:** Standard & Custom Available (See Pages 16 & 17)

**MATERIALS:** Aluminum, Brass, Bronze, Stainless Steel, Leather

**PRODUCT OPTIONS:** Custom Lengths Available





# ARCHITECTURAL DOOR PULLS

## RUBBER

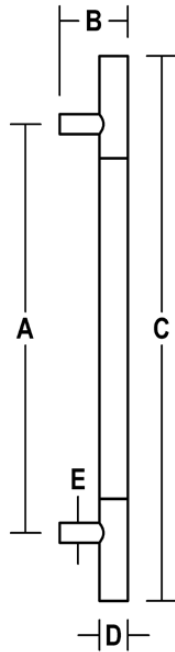

### D630

#### RUBBER GRIP PULL W/ STANDARD POSTS - FLAT ENDS

NO.	A	B	C	D	E
D630	SPECIFY	3"	SPECIFY	Ø 1.25"	Ø 0.875"

**FEATURED FINISHES:** Flat Black (19), Satin Stainless (32D)

**FINISHES:** Standard & Custom Available (See Pages 16 & 17)

**MATERIALS:** Aluminum, Brass, Bronze, Stainless Steel, Rubber

**PRODUCT OPTIONS:** Custom Lengths Available

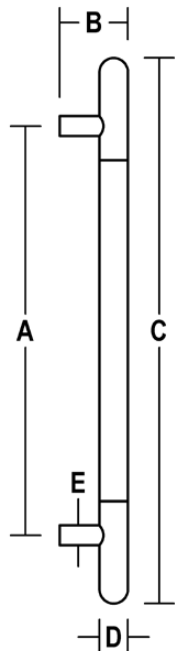

### D631

#### RUBBER GRIP PULL W/ STANDARD POSTS - ROUND ENDS

NO.	A	B	C	D	E
D631	SPECIFY	3"	SPECIFY	Ø 1.25"	Ø 0.875"

**FEATURED FINISHES:** Flat Black (19), Satin Stainless (32D)

**FINISHES:** Standard & Custom Available (See Pages 16 & 17)

**MATERIALS:** Aluminum, Brass, Bronze, Stainless Steel, Rubber

**PRODUCT OPTIONS:** Custom Lengths Available



# ARCHITECTURAL DOOR PULLS

## RUBBER

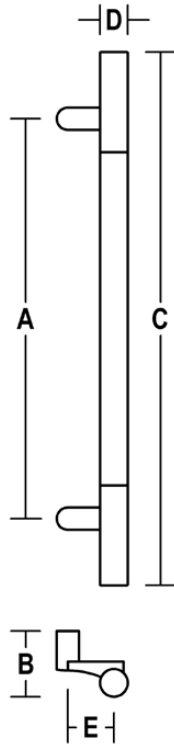

### D632

#### RUBBER GRIP PULL W/ OFFSET H POSTS - FLAT ENDS

NO.	A	B	C	D	E
D632	SPECIFY	3"	SPECIFY	Ø 1.25"	2"

**FEATURED FINISHES:** Flat Black (19), Satin Stainless (32D)

**FINISHES:** Standard & Custom Available (See Pages 16 & 17)

**MATERIALS:** Aluminum, Brass, Bronze, Stainless Steel, Rubber

**PRODUCT OPTIONS:** Custom Lengths Available

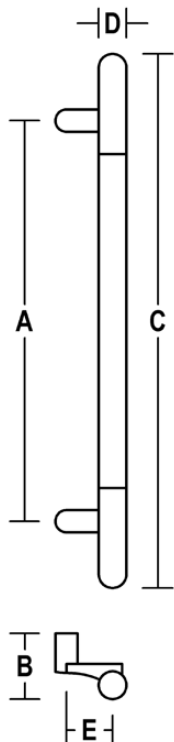

### D633

#### RUBBER GRIP PULL W/ OFFSET H POSTS - ROUND ENDS

NO.	A	B	C	D	E
D633	SPECIFY	3"	SPECIFY	Ø 1.25"	2"

**FEATURED FINISHES:** Flat Black (19), Satin Stainless (32D)

**FINISHES:** Standard & Custom Available (See Pages 16 & 17)

**MATERIALS:** Aluminum, Brass, Bronze, Stainless Steel, Rubber

**PRODUCT OPTIONS:** Custom Lengths Available



# ARCHITECTURAL DOOR PULLS

## RUBBER

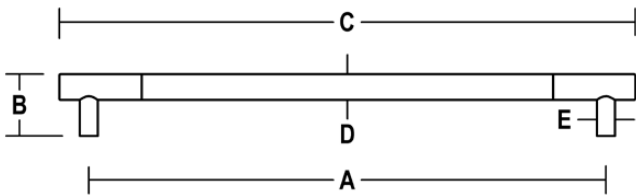

### D634

#### RUBBER GRIP PUSH BAR - FLAT ENDS

NO.	A	B	C	D	E
D634	SPECIFY	3"	SPECIFY	Ø 1.25"	Ø 0.875"

**FEATURED FINISHES:** Flat Black (19), Satin Stainless (32D)

**FINISHES:** Standard & Custom Available (See Pages 16 & 17)

**MATERIALS:** Aluminum, Brass, Bronze, Stainless Steel, Rubber

**PRODUCT OPTIONS:** Custom Lengths Available

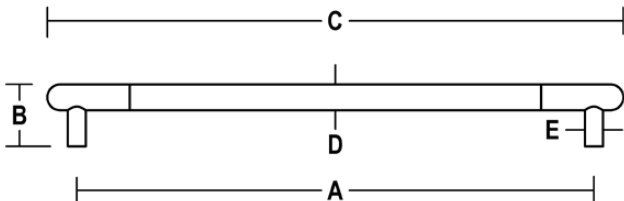

### D635

#### RUBBER GRIP PUSH BAR - ROUND ENDS

NO.	A	B	C	D	E
D635	SPECIFY	3"	SPECIFY	Ø 1.25"	Ø 0.875"

**FEATURED FINISHES:** Flat Black (19), Satin Stainless (32D)

**FINISHES:** Standard & Custom Available (See Pages 16 & 17)

**MATERIALS:** Aluminum, Brass, Bronze, Stainless Steel, Rubber

**PRODUCT OPTIONS:** Custom Lengths Available



# ARCHITECTURAL DOOR PULLS

## SPLIT FINISH

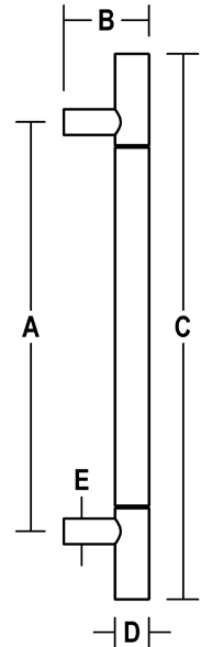

### D500

#### SPLIT FINISH STRAIGHT PULL W/ STANDARD POSTS

NO.	A	B	C	D	E
D500	12"	2.75"	16"	Ø 1"	Ø 0.75"

**FEATURED FINISHES:** Antimicrobial (AM)

**FINISHES:** Standard & Custom Available (See Pages 16 & 17)

**MATERIALS:** Aluminum, Brass, Bronze, Stainless Steel

**PRODUCT OPTIONS:** Custom Lengths Available



# ARCHITECTURAL DOOR PULLS

## SPLIT FINISH

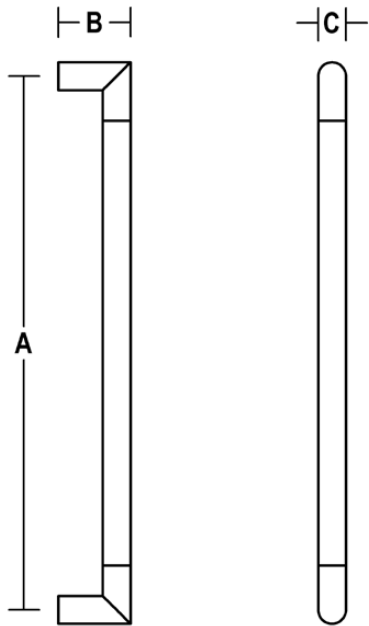

### D422 SPLIT FINISH STRAIGHT PULL - MITERED ENDS

NO.	A	B	C
D422	24"	3.25"	Ø 1.25"

**FEATURED FINISHES:** Antimicrobial (AM)

**FINISHES:** Standard & Custom Available (See Pages 16 & 17)

**MATERIAL:** Stainless Steel

**PRODUCT OPTIONS:** Custom Lengths Available

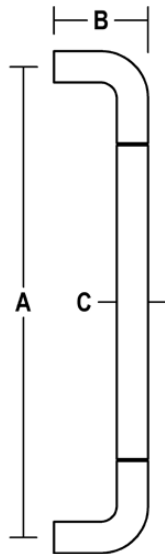

### D531 SPLIT FINISH STRAIGHT PULL W/ BENT ENDS

NO.	A	B	C
D531	15"	3"	Ø 1"

**FEATURED FINISHES:** Antimicrobial (AM)

**FINISHES:** Standard & Custom Available (See Pages 16 & 17)

**MATERIALS:** Aluminum, Brass, Bronze, Stainless Steel

**PRODUCT OPTIONS:** Custom Lengths Available



# ARCHITECTURAL DOOR PULLS

## REEDED

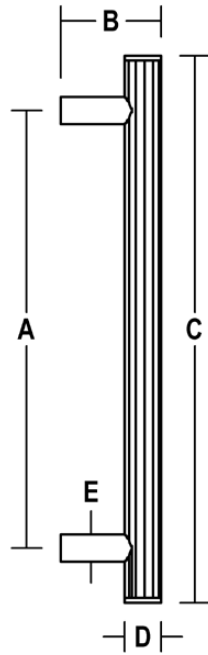
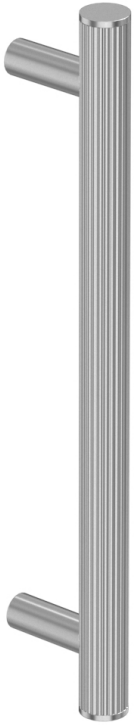

### D512

#### REEDED GRIP STRAIGHT PULL W/ STANDARD POSTS

NO.	A	B	C	D	E
D512	12"	2.75"	15"	Ø 1.5"	Ø 0.875"

**FEATURED FINISHES:** Flat Black (19), Satin Chrome (26D), Antimicrobial (AM)

**FINISHES:** Standard & Custom Available (See Pages 16 & 17)

**MATERIALS:** Brass

**PRODUCT OPTIONS:** Custom Lengths Available

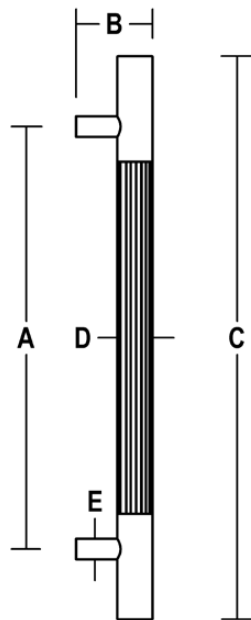

### D591

#### REEDED STRAIGHT PULL W/ STANDARD POSTS

NO.	A	B	C	D	E
D591	SPECIFY	3.25"	SPECIFY	Ø 1.5"	Ø 0.875"

**FEATURED FINISHES:** Flat Black (19), Satin Chrome (26D), Antimicrobial (AM)

**FINISHES:** Standard & Custom Available (See Pages 16 & 17)

**MATERIALS:** Brass

**PRODUCT OPTIONS:** Custom Lengths Available



# ARCHITECTURAL DOOR PULLS

## GROOVES

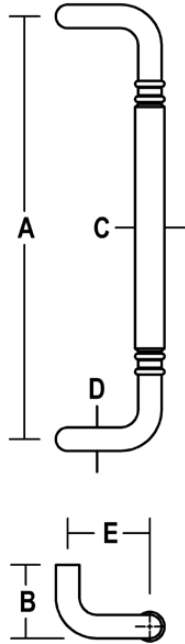

### D365 OFFSET PULL W/ GROOVES

NO.	A	B	C	D	E
D365	18"	3.125"	Ø 1.25"	Ø 1"	3.5"

**FEATURED FINISHES:** Flat Black (19), Satin Stainless (32D), Antimicrobial (AM)

**FINISHES:** Standard & Custom Available (See Pages 16 & 17)

**MATERIALS:** Aluminum, Brass, Bronze, Stainless Steel

**PRODUCT OPTIONS:** Custom Lengths Available

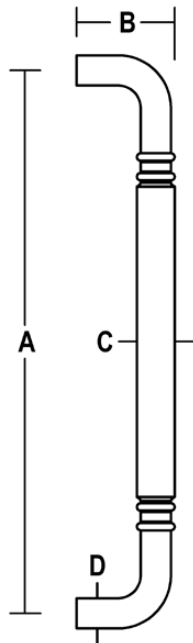

### D413 GROOVED STRAIGHT PULL - BENT ENDS

NO.	A	B	C	D
D413	18"	3.25"	Ø 1.25"	Ø 1"

**FEATURED FINISHES:** Flat Black (19), Satin Stainless (32D), Antimicrobial (AM)

**FINISHES:** Standard & Custom Available (See Pages 16 & 17)

**MATERIALS:** Aluminum, Brass, Bronze, Stainless Steel

**PRODUCT OPTIONS:** Custom Lengths Available



# ARCHITECTURAL DOOR PULLS

## GROOVES

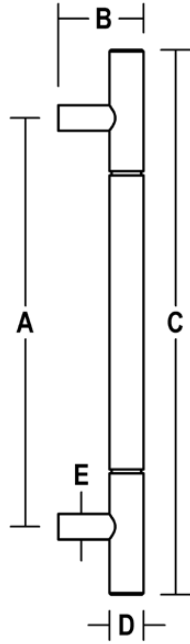

### D514

#### GROOVED STRAIGHT PULL W/ STANDARD POSTS

NO.	A	B	C	D	E
D514	12"	2.75"	16"	Ø 1"	Ø 0.75"

**FEATURED FINISHES:** Flat Black (19), Satin Stainless (32D), Antimicrobial (AM)

**FINISHES:** Standard & Custom Available (See Pages 16 & 17)

**MATERIALS:** Aluminum, Brass, Bronze, Stainless Steel

**PRODUCT OPTIONS:** Custom Lengths Available

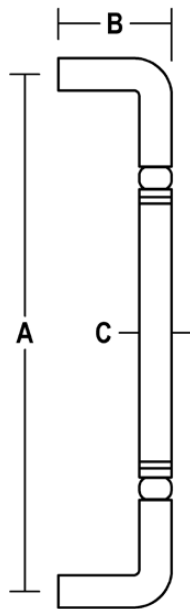

### D533

#### GROOVED STRAIGHT PULL - BENT ENDS

NO.	A	B	C
D533	12"	2.5"	Ø 0.75"

**FEATURED FINISHES:** Flat Black (19), Satin Stainless (32D), Antimicrobial (AM)

**FINISHES:** Standard & Custom Available (See Pages 16 & 17)

**MATERIALS:** Aluminum, Brass, Bronze, Stainless Steel

**PRODUCT OPTIONS:** Custom Lengths Available





# ARCHITECTURAL DOOR PULLS

## GROOVES

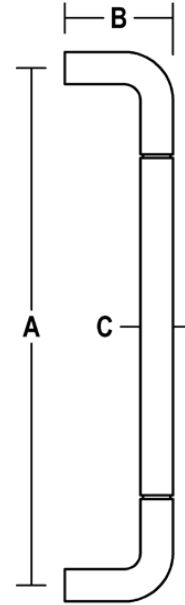

### **D534** GROOVED STRAIGHT PULL - BENT ENDS

<b>NO.</b>	<b>A</b>	<b>B</b>	<b>C</b>
<b>D534</b>	12"	2.5"	Ø 0.75"

**FEATURED FINISHES:** Flat Black (19), Satin Stainless (32D), Antimicrobial (AM)

**FINISHES:** Standard & Custom Available (See Pages 16 & 17)

**MATERIALS:** Aluminum, Brass, Bronze, Stainless Steel

**PRODUCT OPTIONS:** Custom Lengths Available



# ARCHITECTURAL DOOR PULLS

## HEX

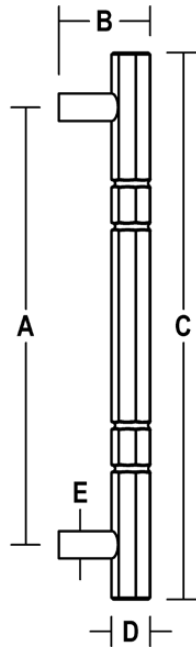
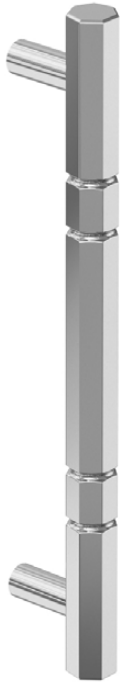

### D516 HEX PULL W/ GROOVES

NO.	A	B	C	D	E
D516	12"	2.75"	15"	1"	Ø 0.75"

**FEATURED FINISHES:** Flat Black (19), Satin Stainless (32D), Antimicrobial (AM)

**FINISHES:** Standard & Custom Available (See Pages 16 & 17)

**MATERIALS:** Aluminum, Brass, Bronze, Stainless Steel

**PRODUCT OPTIONS:** Custom Lengths Available

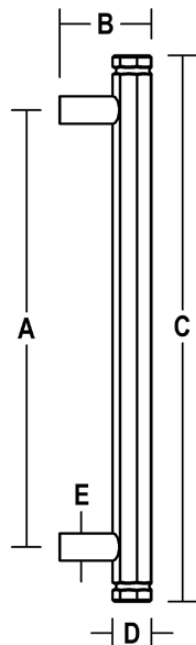

### D517 HEX PULL W/ GROOVES

NO.	A	B	C	D	E
D517	12"	2.75"	15"	1"	Ø 0.75"

**FEATURED FINISHES:** Flat Black (19), Satin Stainless (32D), Antimicrobial (AM)

**FINISHES:** Standard & Custom Available (See Pages 16 & 17)

**MATERIALS:** Aluminum, Brass, Bronze, Stainless Steel

**PRODUCT OPTIONS:** Custom Lengths Available



# ARCHITECTURAL DOOR PULLS

HEX

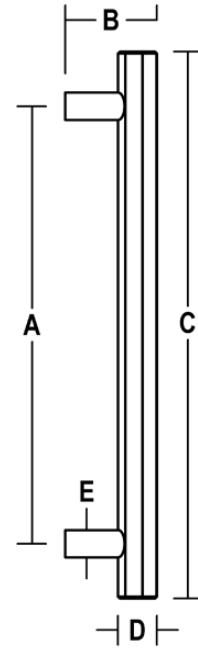
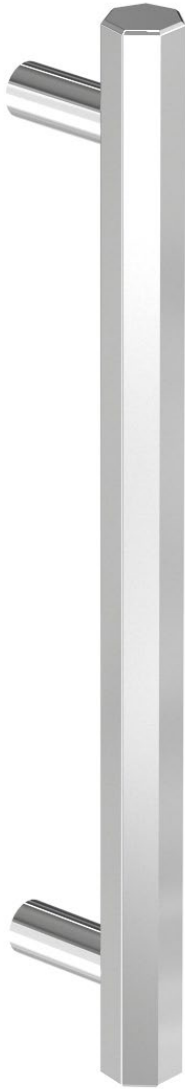

## D525 HEX PULL

NO.	A	B	C	D	E
D525	12"	2.75"	15"	1"	Ø 0.75"

**FEATURED FINISHES:** Flat Black (19), Satin Stainless (32D), Antimicrobial (AM)

**FINISHES:** Standard & Custom Available (See Pages 16 & 17)

**MATERIALS:** Aluminum, Brass, Bronze, Stainless Steel

**PRODUCT OPTIONS:** Custom Lengths Available



# ARCHITECTURAL DOOR PULLS

## CIRCULAR

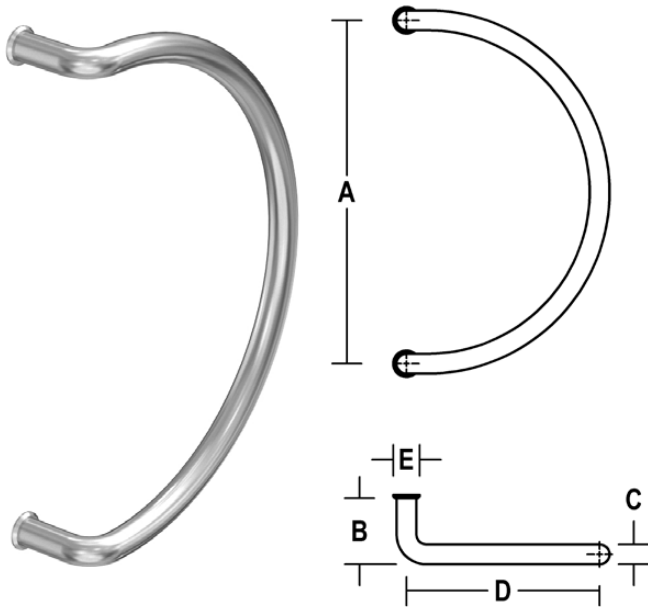

### D362

#### SEMI-CIRCULAR PULL - BENT ENDS

NO.	A	B	C	D	E
D362-1	12"	2.5"	Ø 0.75"	7.25"	Ø 1"
D362-2	12"	3"	Ø 1"	7.5"	Ø 1.25"
D362-3	12"	3.25"	Ø 1.25"	7.75"	N/A

**FEATURED FINISHES:** Flat Black (19), Satin Stainless (32D), Antimicrobial (AM)

**FINISHES:** Standard & Custom Available (See Pages 16 & 17)

**MATERIALS:** Aluminum, Brass, Bronze, Stainless Steel

**PRODUCT OPTIONS:** Custom Sizes Available

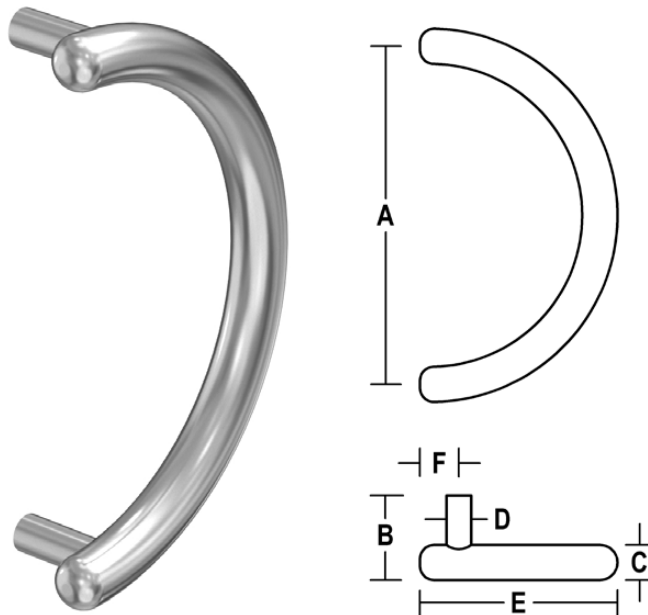

### D363

#### SEMI-CIRCULAR PULL W/ STANDARD POSTS - ROUND ENDS

NO.	A	B	C	D	E	F
D363	12"	3"	Ø 1.25"	Ø 0.875"	7.5"	1.5"

**FEATURED FINISHES:** Flat Black (19), Satin Stainless (32D), Antimicrobial (AM)

**FINISHES:** Standard & Custom Available (See Pages 16 & 17)

**MATERIALS:** Aluminum, Brass, Bronze, Stainless Steel

**PRODUCT OPTIONS:** Custom Sizes Available



# ARCHITECTURAL DOOR PULLS

## CIRCULAR

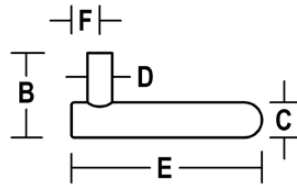
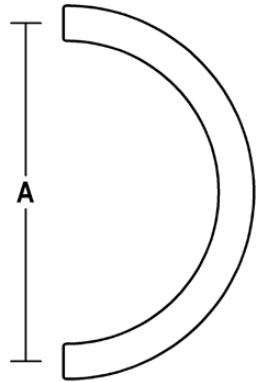

### D364

#### SEMI-CIRCULAR PULL W/ STANDARD POSTS - FLAT ENDS

NO.	A	B	C	D	E	F
D364	12"	3"	Ø 1.25"	Ø 0.875"	7"	1"

**FEATURED FINISHES:** Flat Black (19), Satin Stainless (32D), Antimicrobial (AM)

**FINISHES:** Standard & Custom Available (See Pages 16 & 17)

**MATERIALS:** Aluminum, Brass, Bronze, Stainless Steel

**PRODUCT OPTIONS:** Custom Sizes Available

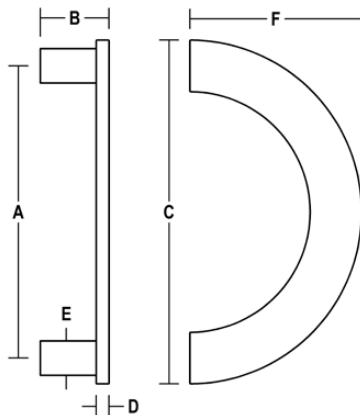

### D373

#### FLAT GRIP SEMI-CIRCULAR PULL

NO.	A	B	C	D	E	F
D373	8.5"	2"	10"	0.375"	Ø 1"	5"

**FEATURED FINISHES:** Flat Black (19), Satin Stainless (32D), Antimicrobial (AM)

**FINISHES:** Standard & Custom Available (See Pages 16 & 17)

**MATERIALS:** Cast Aluminum, Brass, Bronze

**PRODUCT OPTIONS:** Custom Sizes Available



# ARCHITECTURAL DOOR PULLS

## CIRCULAR

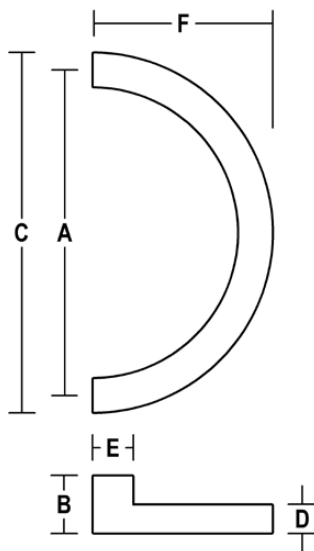

### D374

#### SQUARE GRIP SEMI-CIRCULAR PULL

NO.	A	B	C	D	E	F
D374	14"	2.5"	15"	□ 1"	1"	7.5"

**FEATURED FINISHES:** Flat Black (19), Satin Stainless (32D), Antimicrobial (AM)

**FINISHES:** Standard & Custom Available (See Pages 16 & 17)

**MATERIALS:** Aluminum, Brass, Bronze, Stainless Steel



# ARCHITECTURAL DOOR PULLS

## CIRCULAR

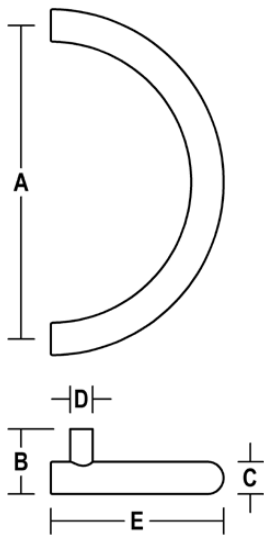

### D572

#### SEMI-CIRCULAR PULL W/ STANDARD POSTS - FLAT ENDS

NO.	A	B	C	D	E
D572	15"	3"	Ø 1.5"	Ø 0.875"	8.5"

**FEATURED FINISHES:** Flat Black (19), Satin Stainless (32D), Antimicrobial (AM)

**FINISHES:** Standard & Custom Available (See Pages 16 & 17)

**MATERIALS:** Aluminum, Brass, Bronze, Stainless Steel

**PRODUCT OPTIONS:** Custom Sizes Available



# ARCHITECTURAL DOOR PULLS

## TRADITIONAL

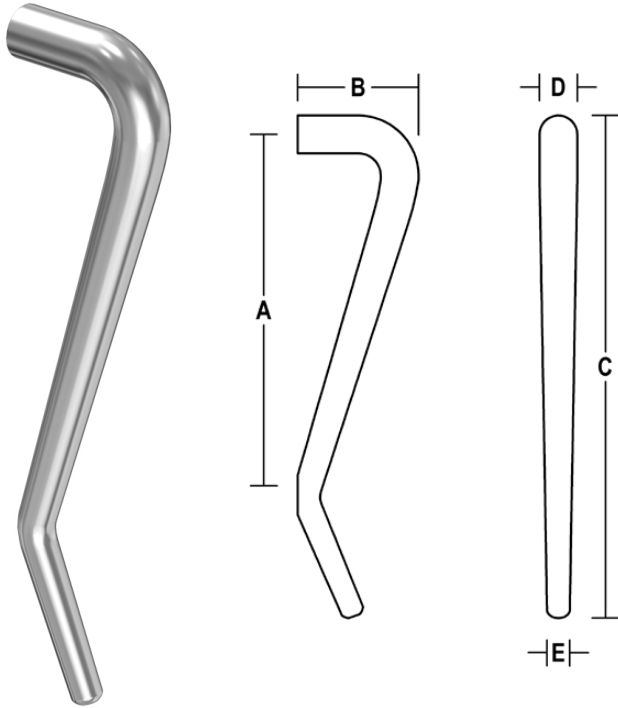

### D377 TRADITIONAL PULL

NO.	A	B	C	D	E
D377	12"	4"	16"	Ø 1.25"	Ø 0.75"

**FEATURED FINISHES:** Flat Black (19), Satin Stainless (32D), Antimicrobial (AM)

**FINISHES:** Standard & Custom Available (See Pages 16 & 17)

**MATERIALS:** Aluminum, Brass, Bronze, Stainless Steel

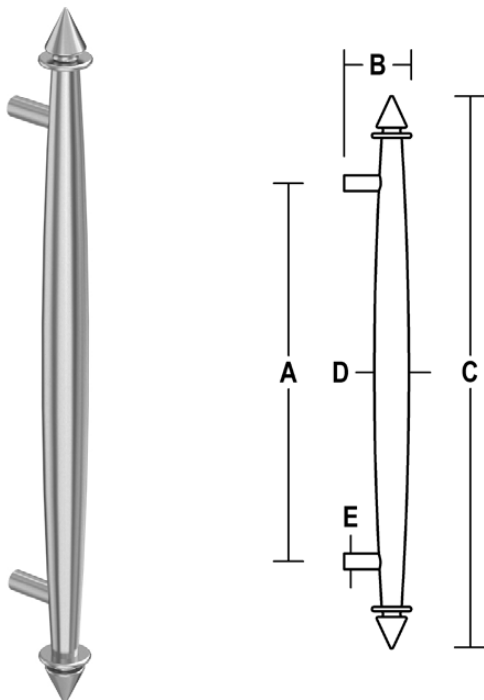

### D502 WIDE GRIP TAPERED PULL W/ STEEPLED ENDS

NO.	A	B	C	D	E
D502	12"	2.5"	17.75"	Ø 1.25"	Ø 0.75"

**FEATURED FINISHES:** Flat Black (19), Satin Stainless (32D), Antimicrobial (AM)

**FINISHES:** Standard & Custom Available (See Pages 16 & 17)

**MATERIALS:** Aluminum, Brass, Bronze, Stainless Steel





# ARCHITECTURAL DOOR PULLS

## TRADITIONAL

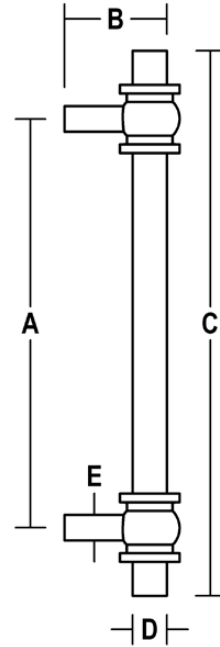
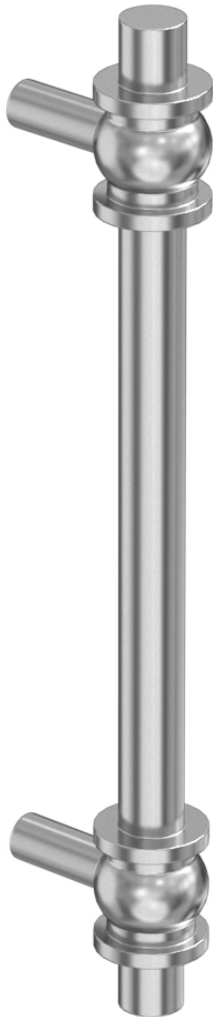

### D545 DECORATIVE PULL

NO.	A	B	C	D	E
D545	12"	3.125"	16"	Ø 1"	Ø 0.75"

**FEATURED FINISHES:** Flat Black (19), Satin Stainless (32D),  
Antimicrobial (AM)

**FINISHES:** Standard & Custom Available (See Pages 16 & 17)

**MATERIALS:** Aluminum, Brass, Bronze, Stainless Steel

**PRODUCT OPTIONS:** Custom Lengths Available



# ARCHITECTURAL DOOR PULLS

## TRADITIONAL

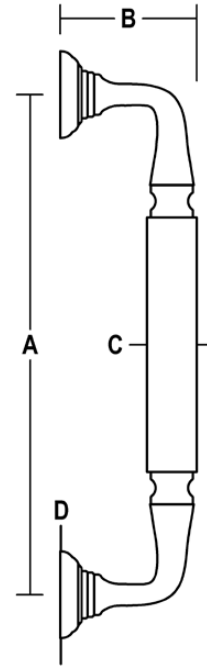

### D562 TRADITIONAL PULL

NO.	A	B	C	D
D562	10"	2.75"	Ø 1"	Ø 1.75"

**FEATURED FINISHES:** Flat Black (19), Satin Chrome (26D), Antimicrobial (AM)

**FINISHES:** Standard & Custom Available (See Pages 16 & 17)

**MATERIALS:** Cast Brass, Bronze



# ARCHITECTURAL DOOR PULLS

## TRADITIONAL

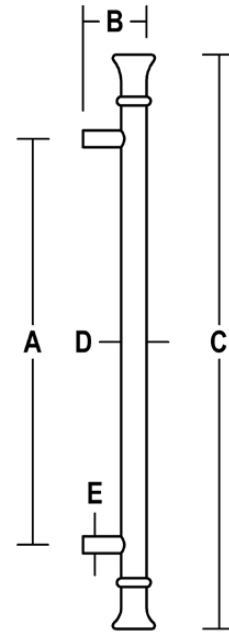

### D521

#### STRAIGHT PULL W/ CLASSIC CAPS

NO.	A	B	C	D	E
D521	12"	2.5"	17"	Ø 0.75"	Ø 0.5"

**FEATURED FINISHES:** Bright Brass (3), Satin Chrome (26D), Antimicrobial (AM)

**FINISHES:** Standard & Custom Available (See Pages 16 & 17)

**MATERIALS:** Brass, Bronze, Stainless Steel

**PRODUCT OPTIONS:** Custom Lengths Available



# ARCHITECTURAL DOOR PULLS

## CLASSIC

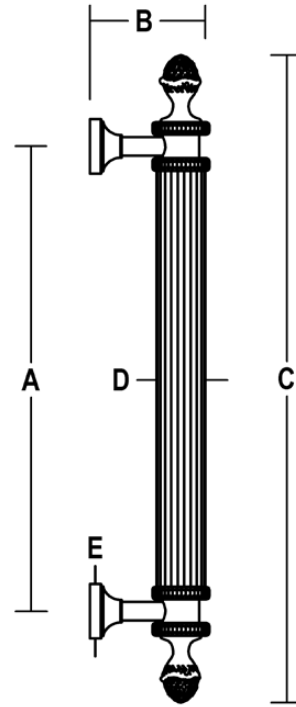
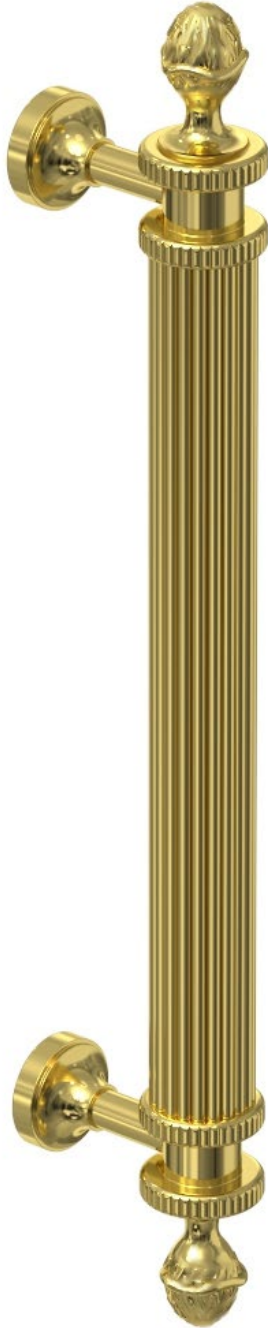

**D392**  
**REEDED CLASSIC PULL**  
**W/ ACORN FINIALS**

NO.	A	B	C	D	E
D392	13"	3.25"	18"	Ø 1.5"	Ø 1.5"

**FEATURED FINISHES:** Bright Brass (3), Satin Chrome (26D),  
 Antimicrobial (AM)

**FINISHES:** Standard & Custom Available (See Pages 16 & 17)

**MATERIALS:** Cast Brass, Bronze

**PRODUCT OPTIONS:** Custom Lengths Available



# ARCHITECTURAL DOOR PULLS

## CLASSIC

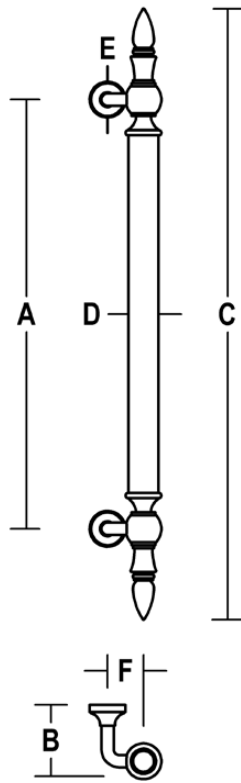

### D508 CLASSIC OFFSET PULL W/ BISHOP FINIALS

NO.	A	B	C	D	E	F
D508-2	18"	2.75"	25.625"	Ø 1"	Ø 1.5"	1.5"
D508-3	18"	3"	25.625"	Ø 1.25"	Ø 1.5"	1.5"
D508-4	18"	3.25"	25.625"	Ø 1.5"	Ø 1.5"	1.5"

**FEATURED FINISHES:** Bright Brass (3), Satin Chrome (26D), Antimicrobial (AM)

**FINISHES:** Standard & Custom Available (See Pages 16 & 17)

**MATERIALS:** Brass, Bronze

**PRODUCT OPTIONS:** Custom Lengths Available • Reeded Grip Available Upon Request

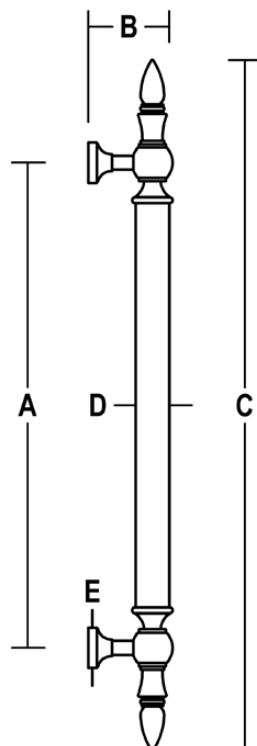
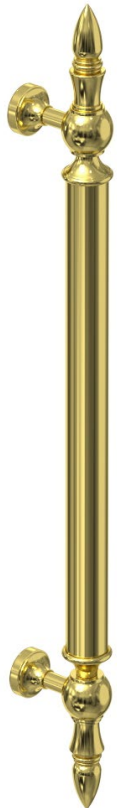

### D509 CLASSIC PULL W/ BISHOP FINIALS

NO.	A	B	C	D	E
D509-2	18"	2.75"	25.625"	Ø 1"	Ø 1.5"
D509-3	18"	3"	25.625"	Ø 1.25"	Ø 1.5"
D509-4	18"	3.25"	25.625"	Ø 1.5"	Ø 1.5"

**FEATURED FINISHES:** Bright Brass (3), Satin Chrome (26D), Antimicrobial (AM)

**FINISHES:** Standard & Custom Available (See Pages 16 & 17)

**MATERIALS:** Brass, Bronze

**PRODUCT OPTIONS:** Custom Lengths Available • Reeded Grip Available Upon Request



# ARCHITECTURAL DOOR PULLS

## CLASSIC

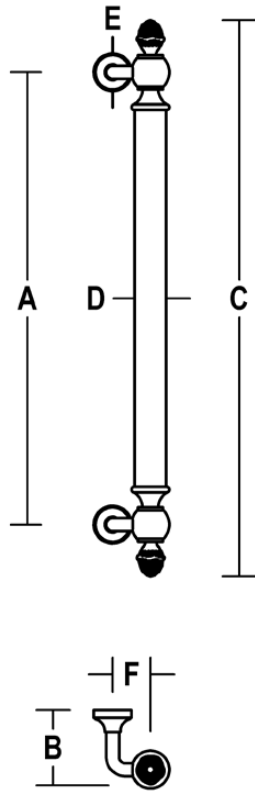
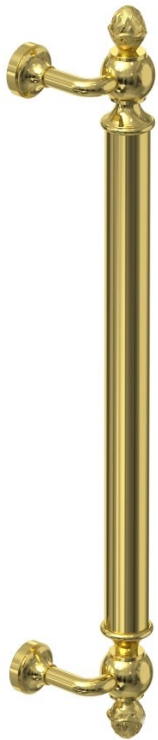

### D567

#### DECORATIVE OFFSET PULL W/ ACORN FINIALS

NO.	A	B	C	D	E	F
D567-2	18"	2.75"	22"	Ø 1"	Ø 1.5"	1.5"
D567-3	18"	3"	22"	Ø 1.25"	Ø 1.5"	1.5"
D567-4	18"	3.25"	22"	Ø 1.5"	Ø 1.5"	1.5"

**FEATURED FINISHES:** Bright Brass (3), Satin Chrome (26D), Antimicrobial (AM)

**FINISHES:** Standard & Custom Available (See Pages 16 & 17)

**MATERIALS:** Cast Brass, Bronze

**PRODUCT OPTIONS:** Custom Lengths Available • Reeded Grip Available Upon Request

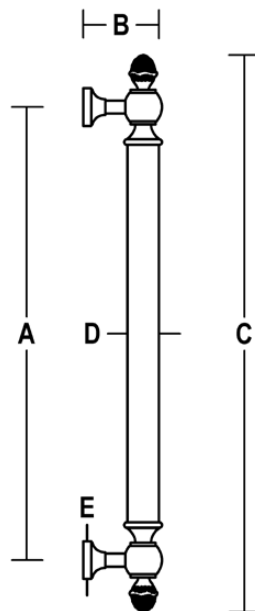
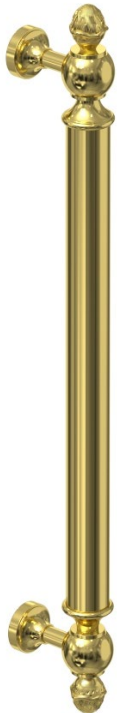

### D568

#### DECORATIVE PULL W/ ACORN FINIALS

NO.	A	B	C	D	E
D568-2	18"	2.75"	22"	Ø 1"	Ø 1.5"
D568-3	18"	3"	22"	Ø 1.25"	Ø 1.5"
D568-4	18"	3.25"	22"	Ø 1.5"	Ø 1.5"

**FEATURED FINISHES:** Bright Brass (3), Satin Chrome (26D), Antimicrobial (AM)

**FINISHES:** Standard & Custom Available (See Pages 16 & 17)

**MATERIALS:** Cast Brass, Bronze

**PRODUCT OPTIONS:** Custom Lengths Available • Reeded Grip Available Upon Request



# ARCHITECTURAL DOOR PULLS

## CLASSIC

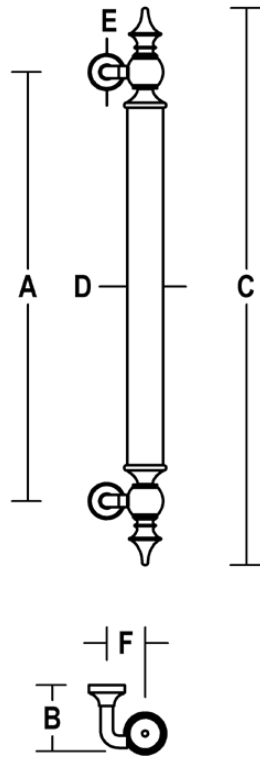
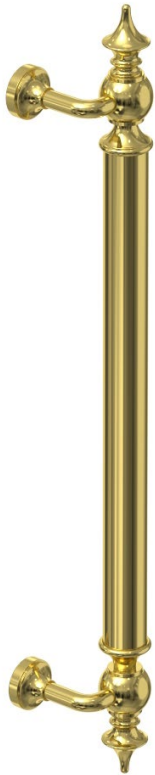

### D581

#### CLASSIC OFFSET PULL W/ SPINTOP FINIALS

NO.	A	B	C	D	E	F
D581-2	18"	2.75"	23.375"	Ø 1"	Ø 1.5"	1.5"
D581-3	18"	3"	23.375"	Ø 1.25"	Ø 1.5"	1.5"
D581-4	18"	3.25"	23.375"	Ø 1.5"	Ø 1.5"	1.5"

**FEATURED FINISHES:** Bright Brass (3), Satin Chrome (26D), Antimicrobial (AM)

**FINISHES:** Standard & Custom Available (See Pages 16 & 17)

**MATERIALS:** Cast Brass, Bronze

**PRODUCT OPTIONS:** Custom Lengths Available • Reeded Grip Available Upon Request

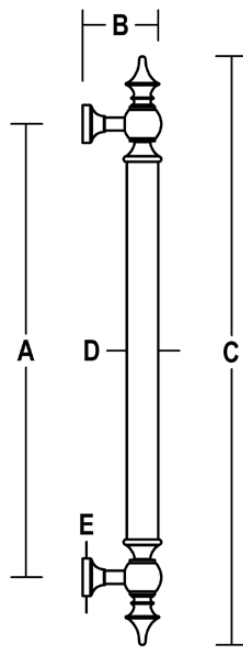

### D582

#### CLASSIC PULL W/ SPINTOP FINIALS

NO.	A	B	C	D	E
D582-2	18"	2.75"	23.375"	Ø 1"	Ø 1.5"
D582-3	18"	3"	23.375"	Ø 1.25"	Ø 1.5"
D582-4	18"	3.25"	23.375"	Ø 1.5"	Ø 1.5"

**FEATURED FINISHES:** Bright Brass (3), Satin Chrome (26D), Antimicrobial (AM)

**FINISHES:** Standard & Custom Available (See Pages 16 & 17)

**MATERIALS:** Brass, Bronze

**PRODUCT OPTIONS:** Custom Lengths Available • Reeded Grip Available Upon Request



# ARCHITECTURAL DOOR PULLS

## INSPIRED DESIGN

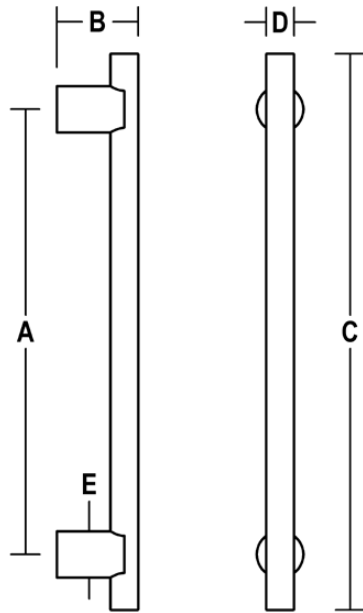

### D379

#### STRAIGHT PULL W/ DESIGNER POSTS

NO.	A	B	C	D	E
D379	12"	2.1875"	15"	Ø 0.75"	Ø 1.25"

**FEATURED FINISHES:** Flat Black (19), Satin Stainless (32D), Antimicrobial (AM)

**FINISHES:** Standard & Custom Available (See Pages 16 & 17)

**MATERIALS:** Aluminum, Brass, Bronze, Stainless Steel

**PRODUCT OPTIONS:** Custom Lengths Available

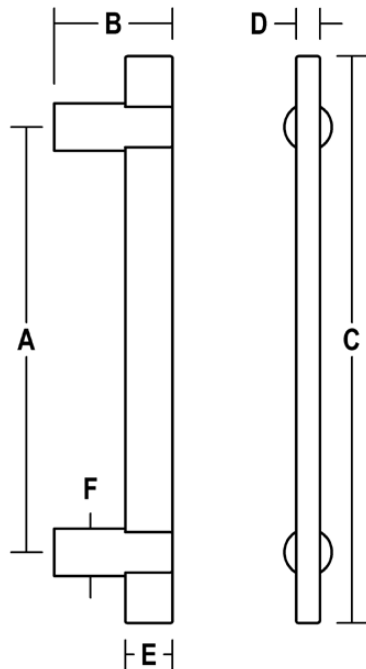
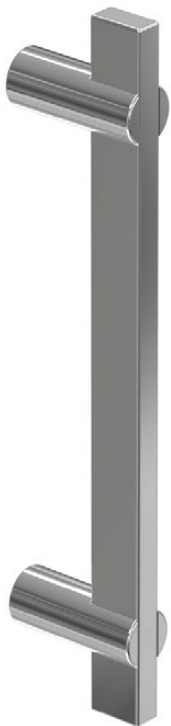

### D406

#### RECTANGULAR PULL W/ DESIGNER POSTS

NO.	A	B	C	D	E	F
D406	9"	2.5"	12"	0.5"	1"	Ø 1"

**FEATURED FINISHES:** Flat Black (19), Satin Stainless (32D), Antimicrobial (AM)

**FINISHES:** Standard & Custom Available (See Pages 16 & 17)

**MATERIALS:** Aluminum, Brass, Bronze, Stainless Steel

**PRODUCT OPTIONS:** Custom Lengths Available





# ARCHITECTURAL DOOR PULLS

## INSPIRED DESIGN

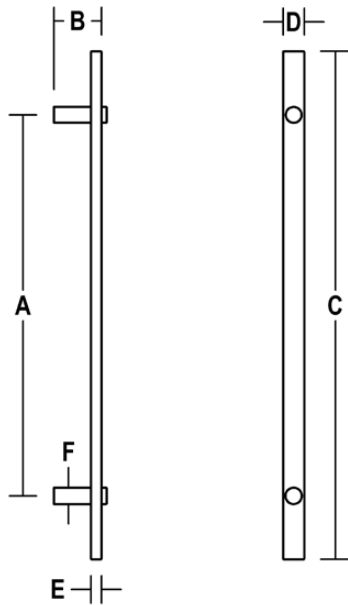

### D405 FLAT GRIP PULL

NO.	A	B	C	D	E	F
D405	18"	2.5"	24"	1"	0.5"	Ø 0.75"

**FEATURED FINISHES:** Flat Black (19), Satin Stainless (32D), Antimicrobial (AM)

**FINISHES:** Standard & Custom Available (See Pages 16 & 17)

**MATERIALS:** Aluminum, Brass, Bronze, Stainless Steel

**PRODUCT OPTIONS:** Custom Lengths Available

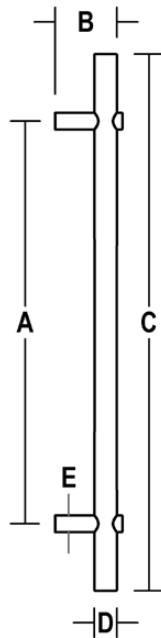

### D410 STRAIGHT PULL W/ DESIGNER POSTS

NO.	A	B	C	D	E
D410	18"	2.75"	24"	Ø 1"	Ø 0.75"

**FEATURED FINISHES:** Flat Black (19), Satin Stainless (32D), Antimicrobial (AM)

**FINISHES:** Standard & Custom Available (See Pages 16 & 17)

**MATERIALS:** Aluminum, Brass, Bronze, Stainless Steel

**PRODUCT OPTIONS:** Custom Lengths Available



# ARCHITECTURAL DOOR PULLS

## INSPIRED DESIGN

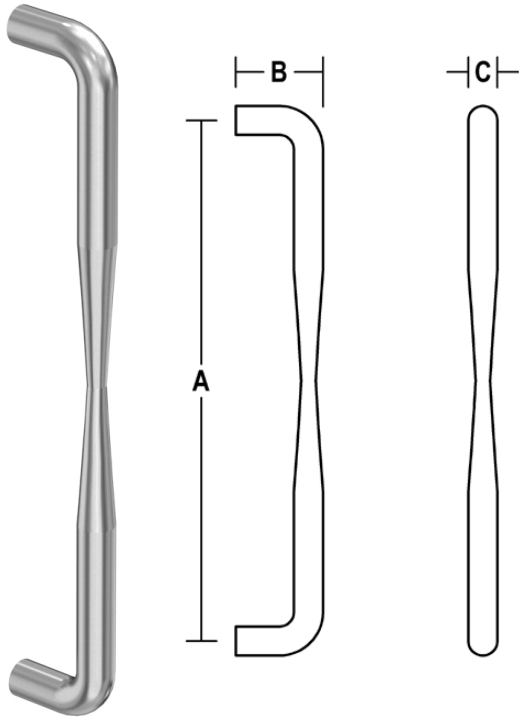

### D400

#### ROUND TAPERED STRAIGHT PULL - BENT ENDS

NO.	A	B	C
D400	18"	3"	Ø 1"

**FEATURED FINISHES:** Flat Black (19), Satin Stainless (32D),  
Antimicrobial (AM)

**FINISHES:** Standard & Custom Available (See Pages 16 & 17)

**MATERIALS:** Aluminum, Brass, Bronze, Stainless Steel

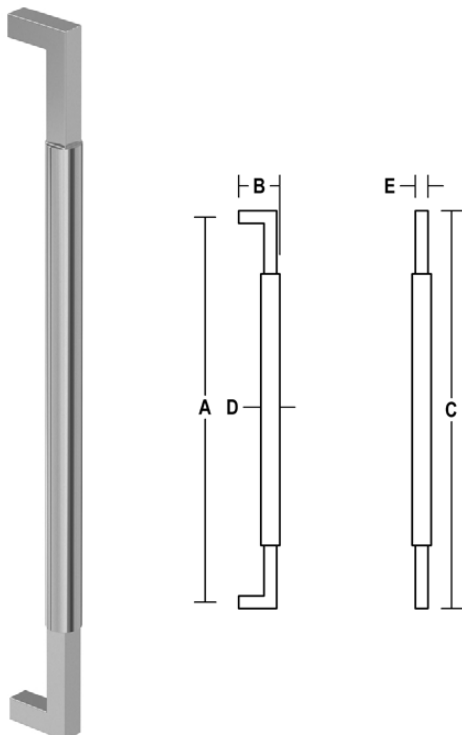

### D418

#### ROUND GRIP SQUARE PULL

NO.	A	B	C	D	E
D418	30.5"	3.25"	31.5"	Ø 1.5"	□ 1"

**FEATURED FINISHES:** Flat Black (19), Satin Stainless (32D),  
Antimicrobial (AM)

**FINISHES:** Standard & Custom Available (See Pages 16 & 17)

**MATERIALS:** Aluminum, Brass, Bronze, Stainless Steel

**PRODUCT OPTIONS:** Custom Lengths Available



# ARCHITECTURAL DOOR PULLS

## INSPIRED DESIGN

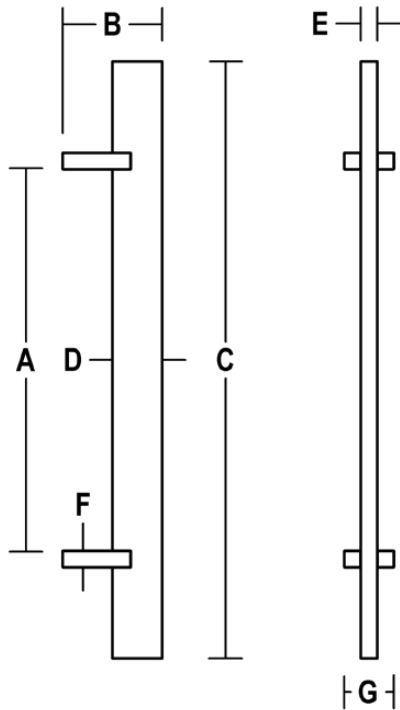
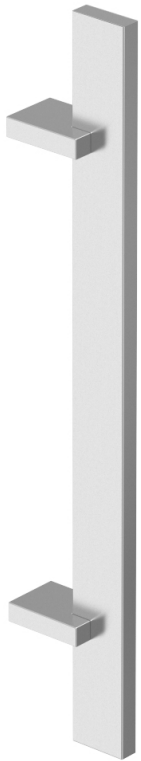

### D433 FLAT GRIP PULL

NO.	A	B	C	D	E	F	G
D433	12"	3"	18"	1.5"	0.5"	0.5"	1.5"

**FEATURED FINISHES:** Flat Black (19), Satin Stainless (32D), Antimicrobial (AM)

**FINISHES:** Standard & Custom Available (See Pages 16 & 17)

**MATERIALS:** Aluminum, Brass, Bronze, Stainless Steel

**PRODUCT OPTIONS:** Custom Lengths Available

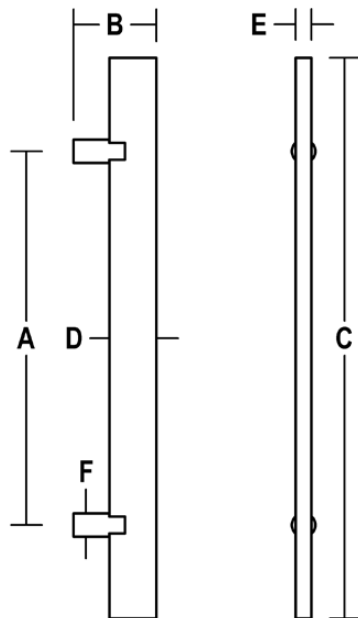

### D436 FLAT GRIP PULL W/ ROUND POSTS

NO.	A	B	C	D	E	F
D436	12"	3"	18"	1.5"	0.5"	Ø 0.75"

**FEATURED FINISHES:** Flat Black (19), Satin Stainless (32D), Antimicrobial (AM)

**FINISHES:** Standard & Custom Available (See Pages 16 & 17)

**MATERIALS:** Aluminum, Brass, Bronze, Stainless Steel

**PRODUCT OPTIONS:** Custom Lengths Available



# ARCHITECTURAL DOOR PULLS

## INSPIRED DESIGN

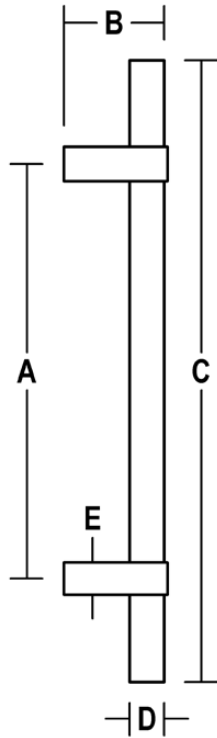

### D398

#### STRAIGHT PULL W/ SIDE MOUNT STRAIGHT POST

NO.	A	B	C	D	E
D398	12"	3"	18"	Ø 1"	Ø 1"

**FEATURED FINISHES:** Flat Black (19), Satin Stainless (32D), Antimicrobial (AM)

**FINISHES:** Standard & Custom Available (See Pages 16 & 17)

**MATERIAL:** Stainless Steel

**PRODUCT OPTIONS:** Custom Lengths Available

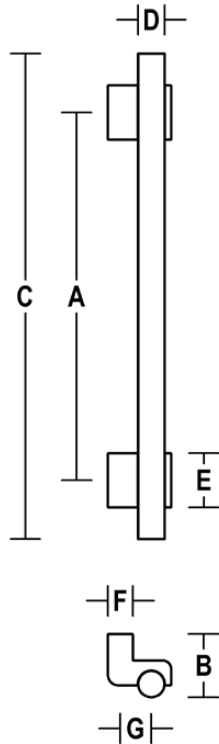

### D503

#### STRAIGHT PULL W/ DESIGNER POSTS

NO.	A	B	C	D	E	F	G
D503	18"	3"	23"	Ø 1.25"	2.5"	1"	1.375"

**FEATURED FINISHES:** Flat Black (19), Satin Stainless (32D), Antimicrobial (AM)

**FINISHES:** Standard & Custom Available (See Pages 16 & 17)

**MATERIALS:** Aluminum, Brass, Bronze, Stainless Steel

**PRODUCT OPTIONS:** Custom Lengths Available



# ARCHITECTURAL DOOR PULLS

## INSPIRED DESIGN

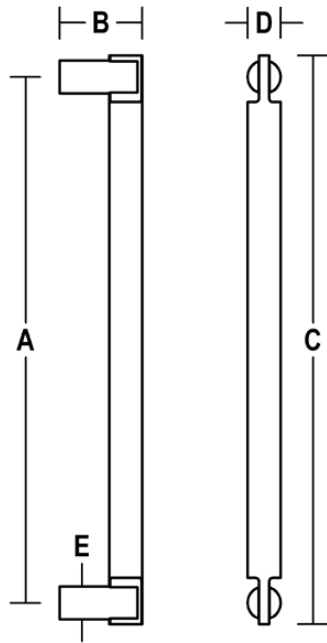

### D506

#### STRAIGHT PULL W/ DESIGNER POSTS

NO.	A	B	C	D
D506	16"	2.5"	17.5"	Ø 1"

**FEATURED FINISHES:** Flat Black (19), Satin Stainless (32D), Antimicrobial (AM)

**FINISHES:** Standard & Custom Available (See Pages 16 & 17)

**MATERIALS:** Brass, Bronze, Stainless Steel

**PRODUCT OPTIONS:** Custom Lengths Available

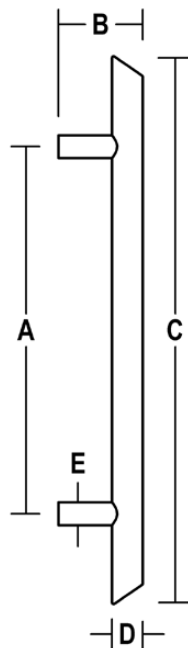

### D524

#### STRAIGHT PULL W/ ANGLED ENDS

NO.	A	B	C	D	E
D524	12"	2.75"	18"	Ø 1"	Ø 0.75"

**FEATURED FINISHES:** Flat Black (19), Satin Stainless (32D), Antimicrobial (AM)

**FINISHES:** Standard & Custom Available (See Pages 16 & 17)

**MATERIALS:** Aluminum, Brass, Bronze, Stainless Steel

**PRODUCT OPTIONS:** Custom Lengths Available



# LOCKING DOOR PULLS

---





# LOCKING DOOR PULLS

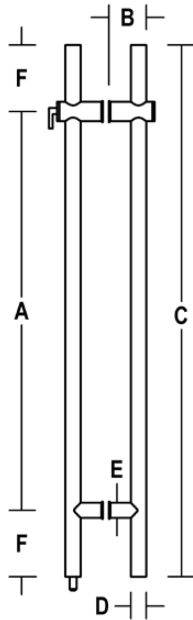

## SMLP3302 LOCKING DOOR PULL - HALF HEIGHT - BOLT DOWN

NO.	A	B	C	D	E	F
SMLP3302	36"	3.325"	48"	1.375"	1.375"	6"

**FEATURED FINISHES:** Flat Black (19), Satin Stainless (32D)

**FINISHES:** 10BE, 19, 32D, PC • Custom Finishes May Be Available

**MATERIAL:** Stainless Steel

**CYLINDER OPTIONS:** Small Format Interchangeable Core (SFIC), Rim Cylinder, Digital Cylinder (Use SMLP3302D), Dummy

**NOTES:** ADA Compliant Thumbturn (Half-turn to fully engage bolt)  
• ADA Compliant Cylinder Height • ADA 10" Clearance From The Floor On The Cylinder Side (SMLP3302C) • For Glass, Wood & Metal Doors • 1.25" Adjustable Bolt Throw • Includes Dustproof Floor Strike • Custom Sizes Available

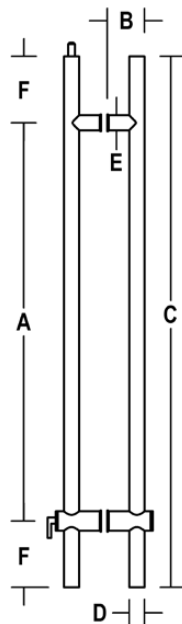

## SMLP3303 LOCKING DOOR PULL - HALF HEIGHT - BOLT UP

NO.	A	B	C	D	E	F
SMLP3303	VARIABLE	3.325"	SPECIFY	1.375"	1.375"	6"

**FEATURED FINISHES:** Flat Black (19), Satin Stainless (32D)

**FINISHES:** 10BE, 19, 32D, PC • Custom Finishes May Be Available

**MATERIAL:** Stainless Steel

**CYLINDER OPTIONS:** Small Format Interchangeable Core (SFIC), Rim Cylinder, Digital Cylinder (Use SMLP3303D), Dummy

**NOTES:** ADA Compliant Thumbturn (Half-turn to fully engage bolt) • For Glass, Wood & Metal Doors • 1.25" Adjustable Bolt Throw • Frame and Transom Strikes Available





# LOCKING DOOR PULLS

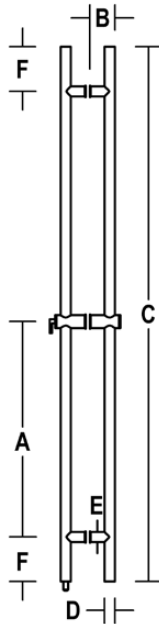

## SMLP3304 LOCKING DOOR PULL - FULL HEIGHT - BOLT DOWN

NO.	A	B	C	D	E	F
SMLP3304	36"	3.325"	SPECIFY	1.375"	1.375"	6"

**FEATURED FINISHES:** Flat Black (19), Satin Stainless (32D)

**FINISHES:** 10BE, 19, 32D, PC • Custom Finishes May Be Available

**MATERIAL:** Stainless Steel

**CYLINDER OPTIONS:** Small Format Interchangeable Core (SFIC), Rim Cylinder, Digital Cylinder (Use SMLP3304D), Dummy

**NOTES:** ADA Compliant Thumbturn (half-turn to fully engage bolt)

• ADA Compliant Cylinder Height • ADA 10" Clearance From The Floor On The Cylinder Side (SMLP3304C) • For Glass, Wood & Metal Doors

• 1.25" Adjustable Bolt Throw • Includes Dustproof Floor Strike

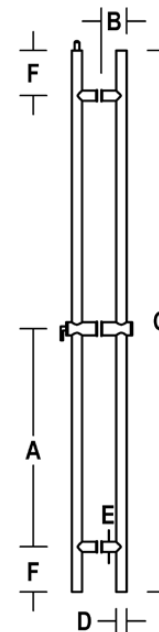

## SMLP3305 LOCKING DOOR PULL - FULL HEIGHT - BOLT UP

NO.	A	B	C	D	E	F
SMLP3305	36"	3.325"	SPECIFY	1.375"	1.375"	6"

**FEATURED FINISHES:** Flat Black (19), Satin Stainless (32D),

**FINISHES:** 10BE, 19, 32D, PC • Custom Finishes May Be Available

**MATERIAL:** Stainless Steel

**CYLINDER OPTIONS:** Small Format Interchangeable Core (SFIC), Rim Cylinder, Digital Cylinder (Use SMLP3305D), Dummy

**NOTES:** ADA Compliant Thumbturn (Half-turn to fully engage bolt)

• ADA Compliant Cylinder Height • ADA 10" Clearance From The Floor On The Cylinder Side (SMLP3305C) • For Glass, Wood & Metal Doors •

1.25" Adjustable Bolt Throw • Frame and Transom Strikes Available



# LOCKING DOOR PULLS

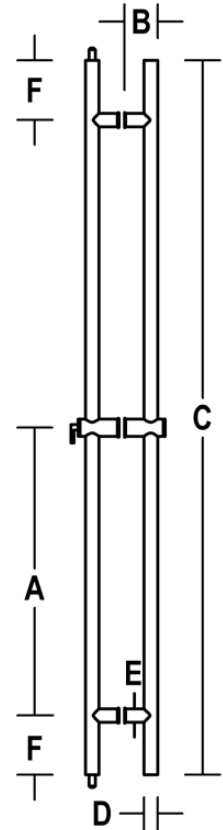

## **SMLP3306** **LOCKING DOOR PULL - FULL HEIGHT** **- BOLT UP & DOWN**

<b>NO.</b>	<b>A</b>	<b>B</b>	<b>C</b>	<b>D</b>	<b>E</b>	<b>F</b>
<b>SMLP3306</b>	36"	3.325"	SPECIFY	1.375"	1.375"	6"

**FEATURED FINISHES:** Flat Black (19), Satin Stainless (32D)

**FINISHES:** 10BE, 19, 32D, PC • Custom Finishes May Be Available

**MATERIAL:** Stainless Steel

**CYLINDER OPTIONS:** Small Format Interchangeable Core (SFIC), Rim Cylinder, Digital Cylinder (Use SMLP3306D), Dummy

**NOTES:** ADA Compliant Thumbturn (half-turn to fully engage bolt)  
• ADA Compliant Cylinder Height • ADA 10" Clearance From The Floor On The Cylinder Side (SMLP3306C) • For Glass, Wood & Metal Doors • 1.25" Adjustable Bolt Throw • Includes Dustproof Floor Strike • Frame and Transom Strikes Available



# LOCKING DOOR PULLS

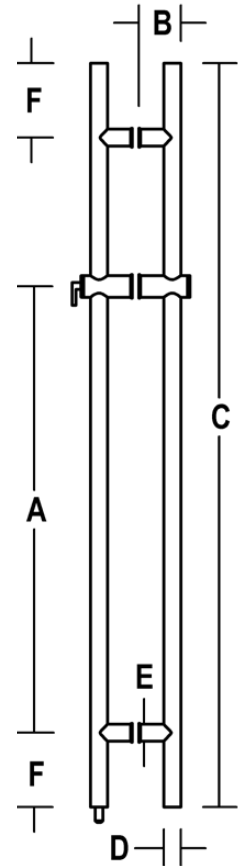
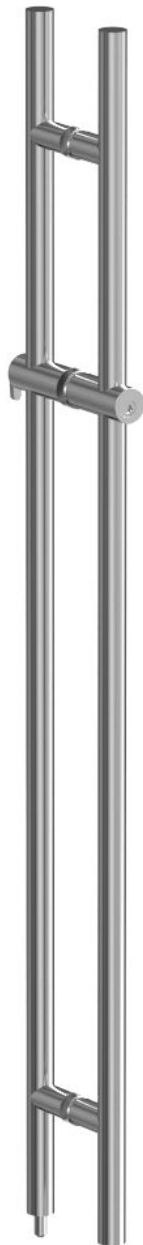

## **SMLP3307** **LOCKING DOOR PULL - 3/4 HEIGHT** **- BOLT DOWN**

<b>NO.</b>	<b>A</b>	<b>B</b>	<b>C</b>	<b>D</b>	<b>E</b>	<b>F</b>
<b>SMLP3306</b>	36"	3.325"	60"	1.375"	1.375"	6"

**FEATURED FINISHES:** Flat Black (19), Satin Stainless (32D)

**FINISHES:** 10BE, 19, 32D, PC • Custom Finishes May Be Available

**MATERIAL:** Stainless Steel

**CYLINDER OPTIONS:** Small Format Interchangeable Core (SFIC), Rim Cylinder, Digital Cylinder (Use SMLP3307D), Dummy

**NOTES:** ADA Compliant Thumbturn (half-turn to fully engage bolt)

• ADA Compliant Cylinder Height • ADA 10" Clearance From The Floor On The Cylinder Side (SMLP3307C) • For Glass, Wood & Metal Doors

• 1.25" Adjustable Bolt Throw • Includes Dustproof Floor Strike



# PATCH LOCK FITTINGS

---



**126** STANDARD MORTISE

**128** DIGITAL ACCESS

**130** ELECTRIC STRIKE

**133** CUSTOM





# PATCH LOCK FITTINGS

## STANDARD MORTISE

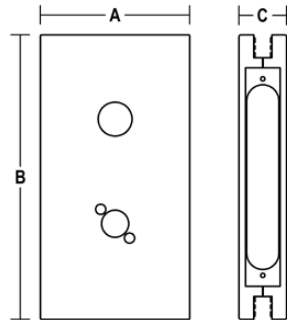

### SMPL510-L9000 PATCH FITTING FOR SCHLAGE L9000 SERIES

NO.	A	B	C
SMPL510-L9000-LS	5.5"	10.5"	1.75"
SMPL510-L9000-SS	5.5"	10.5"	1.75"

**FEATURED FINISHES:** Flat Black (19), Satin Stainless (32D)

**FINISHES:** Standard & Custom Available (See Pages 16 & 17)

**MATERIALS:** Brass, Stainless Steel

**COMPATIBILITY:** Schlage L9000 Series Mortise Lock (LS),  
Schlage L9000 Series ASA Strike (SS)

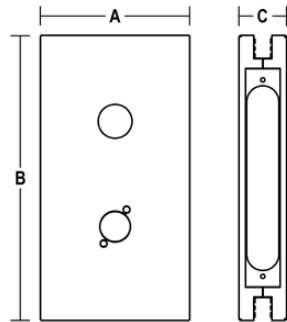

### SMPL510-8200 PATCH FITTING FOR SARGENT 8200 SERIES

NO.	A	B	C
SMPL510-8200-LS	5.5"	10.5"	1.75"
SMPL510-8200-SS	5.5"	10.5"	1.75"

**FEATURED FINISHES:** Flat Black (19), Satin Stainless (32D)

**FINISHES:** Standard & Custom Available (See Pages 16 & 17)

**MATERIALS:** Brass, Stainless Steel

**COMPATIBILITY:** Sargent 8200 Series Mortise Lock (LS),  
Sargent 8200 Series ASA Strike (SS)

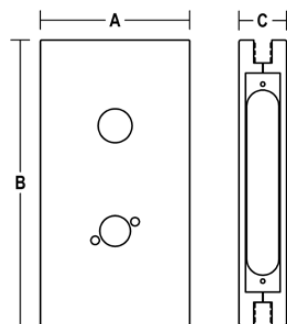

### SMPL510-8800 PATCH FITTING FOR YALE 8800 SERIES

NO.	A	B	C
SMPL510-8800-LS	5.5"	10.5"	1.75"
SMPL510-8800-SS	5.5"	10.5"	1.75"

**FEATURED FINISHES:** Flat Black (19), Satin Stainless (32D)

**FINISHES:** Standard & Custom Available (See Pages 16 & 17)

**MATERIALS:** Brass, Stainless Steel

**COMPATIBILITY:** Yale 8800 Series Mortise Lock (LS),  
Yale 8800 Series ASA Strike (SS)



# PATCH LOCK FITTINGS

## STANDARD MORTISE

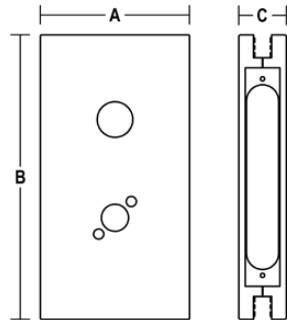

### SMPL510-NM8070 PATCH FITTING FOR CAL - ROYAL NM8070 SERIES

NO.	A	B	C
SMPL510-NM8070-LS	5.5"	10.5"	1.75"
SMPL510-NM8070-SS	5.5"	10.5"	1.75"

**FEATURED FINISHES:** Flat Black (19), Satin Stainless (32D)

**FINISHES:** Standard & Custom Available (See Pages 16 & 17)

**MATERIALS:** Brass, Stainless Steel

**COMPATIBILITY:** Cal-Royal NM8070 Mortise Lock (LS),  
Cal-Royal NM8070 ASA Strike (SS)

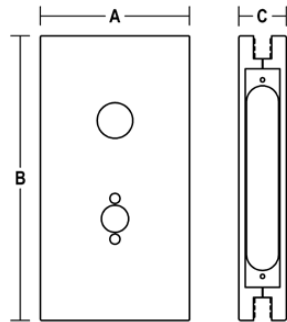

### SMPL510-ML2000 PATCH FITTING FOR CORBIN ML2000 SERIES

NO.	A	B	C
SMPL510-ML2000-LS	5.5"	10.5"	1.75"
SMPL510-ML2000-SS	5.5"	10.5"	1.75"

**FEATURED FINISHES:** Flat Black (19), Satin Stainless (32D)

**FINISHES:** Standard & Custom Available (See Pages 16 & 17)

**MATERIALS:** Brass, Stainless Steel

**COMPATIBILITY:** Corbin ML2000 Series Mortise Lock (LS),  
Corbin ML2000 Series ASA Strike (SS)

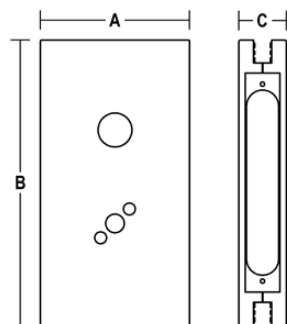

### SMPL510-M1 PATCH FITTING FOR COLOMBO M1 SERIES

NO.	A	B	C
SMPL510-M1-LS	5.5"	10.5"	1.75"
SMPL510-M1-SS	5.5"	10.5"	1.75"

**FEATURED FINISHES:** Flat Black (19), Satin Stainless (32D)

**FINISHES:** Standard & Custom Available (See Pages 16 & 17)

**MATERIALS:** Brass, Stainless Steel

**COMPATIBILITY:** Colombo M1 Series Mortise Lock (LS),  
Colombo M1 Series ASA Strike (SS)



# PATCH LOCK FITTINGS

## DIGITAL ACCESS

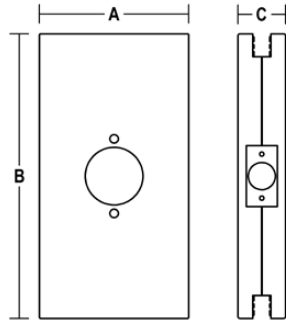

### SMPL510-XS4MINI PATCH FITTING FOR SALTO XS4 MINI

NO.	A	B	C
SMPL510-XS4MINI-LS	5.5"	10.5"	1.75"
SMPL510-XS4MINI-SS	5.5"	10.5"	1.75"

**FEATURED FINISHES:** Flat Black (19), Satin Stainless (32D)

**FINISHES:** Standard & Custom Available (See Pages 16 & 17)

**MATERIALS:** Brass, Stainless Steel

**COMPATIBILITY:** Salto XS4 Mini Cylinder Lock (LS),  
Salto XS4 Mini Strike (SS)

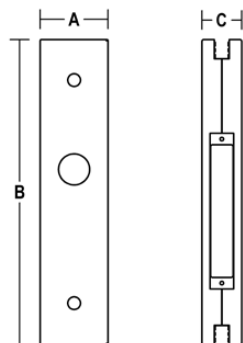

### SMPL313-XS4ONE SLIM-LINE PATCH FITTING FOR SALTO XS4 ONE

NO.	A	B	C
SMPL313-XS4ONE-LS	3"	13.5"	1.75"
SMPL313-XS4ONE-SS	3"	13.5"	1.75"

**FEATURED FINISHES:** Flat Black (19), Satin Stainless (32D)

**FINISHES:** Standard & Custom Available (See Pages 16 & 17)

**MATERIALS:** Brass, Stainless Steel

**COMPATIBILITY:** Salto XS4 One Lock System / Adams Rite 4500 (LS),  
Salto XS4 One Lock System / Adams Rite 4500 (SS)





# PATCH LOCK FITTINGS

## DIGITAL ACCESS

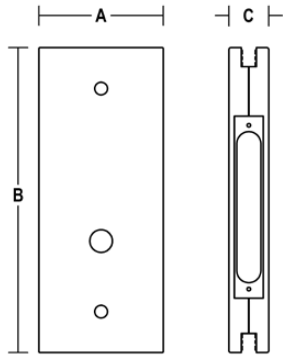

### SMPL513-XS4 PATCH FITTING FOR SALTO XS4

NO.	A	B	C
SMPL513-XS4-LS	5.5"	13.5"	1.75"
SMPL513-XS4-SS	5.5"	13.5"	1.75"

**FEATURED FINISHES:** Flat Black (19), Satin Stainless (32D)

**FINISHES:** Standard & Custom Available (See Pages 16 & 17)

**MATERIALS:** Brass, Stainless Steel

**COMPATIBILITY:** Salto XS4 Electronic Mortise Lock (LS),  
Salto XS4 ASA Strike (SS)

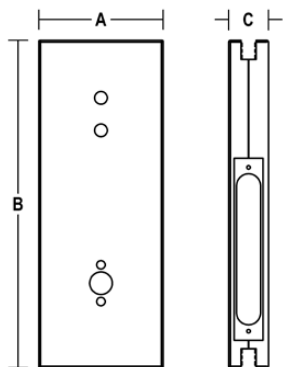

### SMPL514-AE PATCH FITTING FOR SALTO A-ELEMENT

NO.	A	B	C
SMPL514-AE-LS	5.5"	14.5"	1.75"
SMPL514-AE-SS	5.5"	14.5"	1.75"

**FEATURED FINISHES:** Flat Black (19), Satin Stainless (32D)

**FINISHES:** Standard & Custom Available (See Pages 16 & 17)

**MATERIALS:** Brass, Stainless Steel

**COMPATIBILITY:** Salto AElement Electronic Mortise Lock (LS),  
Salto AElement ASA Strike (SS)



# PATCH LOCK FITTINGS

## ELECTRIC STRIKES

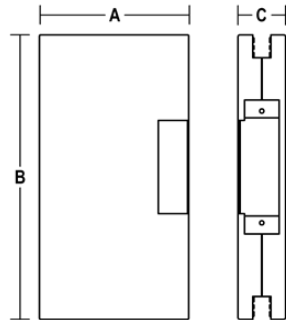

### SMPL510-HES1500-ES

#### PATCH FITTING FOR HES 1500 SERIES

NO.	A	B	C
SMPL510-HES1500-ES	5.5"	10.5"	1.75"

**FEATURED FINISHES:** Flat Black (19), Satin Stainless (32D)

**FINISHES:** Standard & Custom Available (See Pages 16 & 17)

**MATERIALS:** Brass, Stainless Steel

**COMPATIBILITY:** HES 1500 Electric Strike (ES)

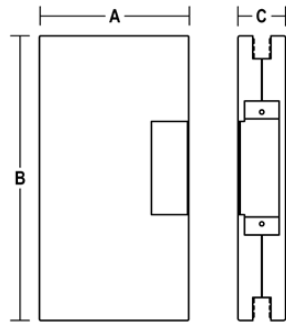

### SMPL510-HES1600-ES

#### PATCH FITTING FOR HES 1600 SERIES

NO.	A	B	C
SMPL510-HES1600-ES	5.5"	10.5"	1.75"

**FEATURED FINISHES:** Flat Black (19), Satin Stainless (32D)

**FINISHES:** Standard & Custom Available (See Pages 16 & 17)

**MATERIALS:** Brass, Stainless Steel

**COMPATIBILITY:** HES 1600 Electric Strike (ES)

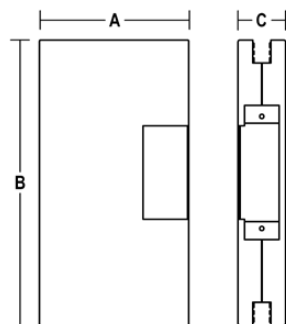

### SMPL510-HES1006-ES

#### PATCH FITTING FOR HES 1006 SERIES

NO.	A	B	C
SMPL510-HES1006-ES	5.5"	10.5"	1.75"

**FEATURED FINISHES:** Flat Black (19), Satin Stainless (32D)

**FINISHES:** Standard & Custom Available (See Pages 16 & 17)

**MATERIALS:** Brass, Stainless Steel

**COMPATIBILITY:** HES 1006 Electric Strike (ES)



# PATCH LOCK FITTINGS

## ELECTRIC STRIKES

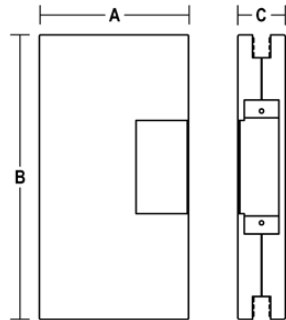

### SMPL510-GK1300-ES

#### PATCH FITTING FOR GIANNI GK1300

NO.	A	B	C
SMPL510-GK1300-ES	5.5"	10.5"	1.75"

**FEATURED FINISHES:** Flat Black (19), Satin Stainless (32D)

**FINISHES:** Standard & Custom Available (See Pages 16 & 17)

**MATERIALS:** Brass, Stainless Steel

**COMPATIBILITY:** Gianni GK1300 Electric Strike (ES)

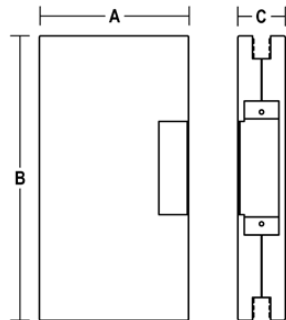

### SMPL510-L6514-ES

#### PATCH FITTING FOR RCI L6514

NO.	A	B	C
SMPL510-L6514-ES	5.5"	10.5"	1.75"

**FEATURED FINISHES:** Flat Black (19), Satin Stainless (32D)

**FINISHES:** Standard & Custom Available (See Pages 16 & 17)

**MATERIALS:** Brass, Stainless Steel

**COMPATIBILITY:** RCI L6514 Electric Strike (ES)

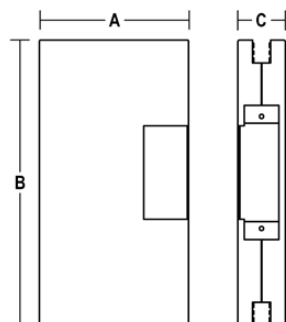

### SMPL510-6400-ES

#### PATCH FITTING FOR VON DUPRIN 6400 SERIES

NO.	A	B	C
SMPL510-6400-ES	5.5"	10.5"	1.75"

**FEATURED FINISHES:** Flat Black (19), Satin Stainless (32D)

**FINISHES:** Standard & Custom Available (See Pages 16 & 17)

**MATERIALS:** Brass, Stainless Steel

**COMPATIBILITY:** Von Duprin 6400 Series Electric Strike (ES)



# PATCH LOCK FITTINGS

## ELECTRIC STRIKES



### SMPL-UCH48

#### 48" TOP U-CHANNEL FOR ELECTRIC STRIKE WIRE RACEWAY

NO.	WIDTH	LEGS	LENGTH
SMPL-UCH48	0.5" I.D.	0.5"	48"

**FEATURED FINISHES:** Flat Black (19), Satin Stainless (32D)

**FINISHES:** Standard & Custom Available (See Pages 16 & 17)

**MATERIALS:** Brass, Stainless Steel

**APPLICATIONS:** For use in concealing electric strike wiring along the top edge of the glass door when using the SMPL510-ES patch fitting.

**NOTES:** Custom Sizes Available



### SMPL-UCH60

#### 60" SIDE U-CHANNEL FOR ELECTRIC STRIKE WIRE RACEWAY

NO.	WIDTH	LEGS	HEIGHT
SMPL-UCH60	0.5" I.D.	0.5"	60"

**FEATURED FINISHES:** Flat Black (19), Satin Stainless (32D)

**FINISHES:** Standard & Custom Available (See Pages 16 & 17)

**MATERIALS:** Brass, Stainless Steel

**APPLICATIONS:** For use in concealing electric strike wiring along the side edge of the glass door when using the SMPL510-ES patch fitting.

**NOTES:** Custom Sizes Available • Tongue and groove design creates a finished look when paired with the SMPL510-ES patch fitting



# PATCH LOCK FITTINGS

## CUSTOM

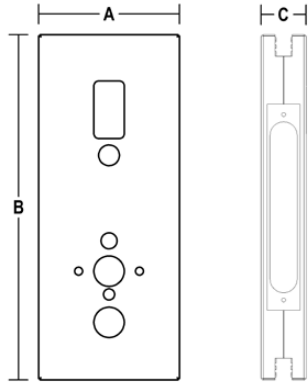

### SMPL830-LS

#### CUSTOM PATCH LOCK FITTING - LOCK SIDE

NO.	A	B	C
SMPL830-SS	VARIABLES	VARIABLES	1.75"

**FEATURED FINISHES:** Flat Black (19), Satin Stainless (32D)

**FINISHES:** Standard & Custom Available (See Pages 16 & 17)

**MATERIALS:** Brass, Stainless Steel

**APPLICATIONS:** Mortise Locks, Electronic Locks, Cylinder Locks, Access Control Systems

**NOTES:** Custom Sizes Available • Customizable to work with most locking systems

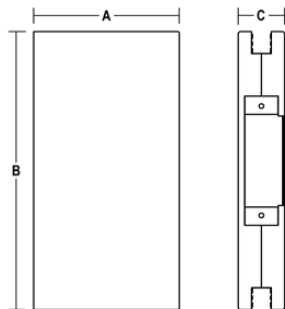

### SMPL830-SS

#### CUSTOM PATCH LOCK FITTING - STRIKE SIDE

NO.	A	B	C
SMPL830-SS	VARIABLES	VARIABLES	1.75"

**FEATURED FINISHES:** Flat Black (19), Satin Stainless (32D)

**FINISHES:** Standard & Custom Available (See Pages 16 & 17)

**MATERIALS:** Brass, Stainless Steel

**APPLICATIONS:** ASA Strikes, Electric Strikes, Custom Strikes, Access Control Systems

**NOTES:** Custom Sizes Available • Customizable to work with most locking systems



# FLUSH PULLS & PULL PLATES

---

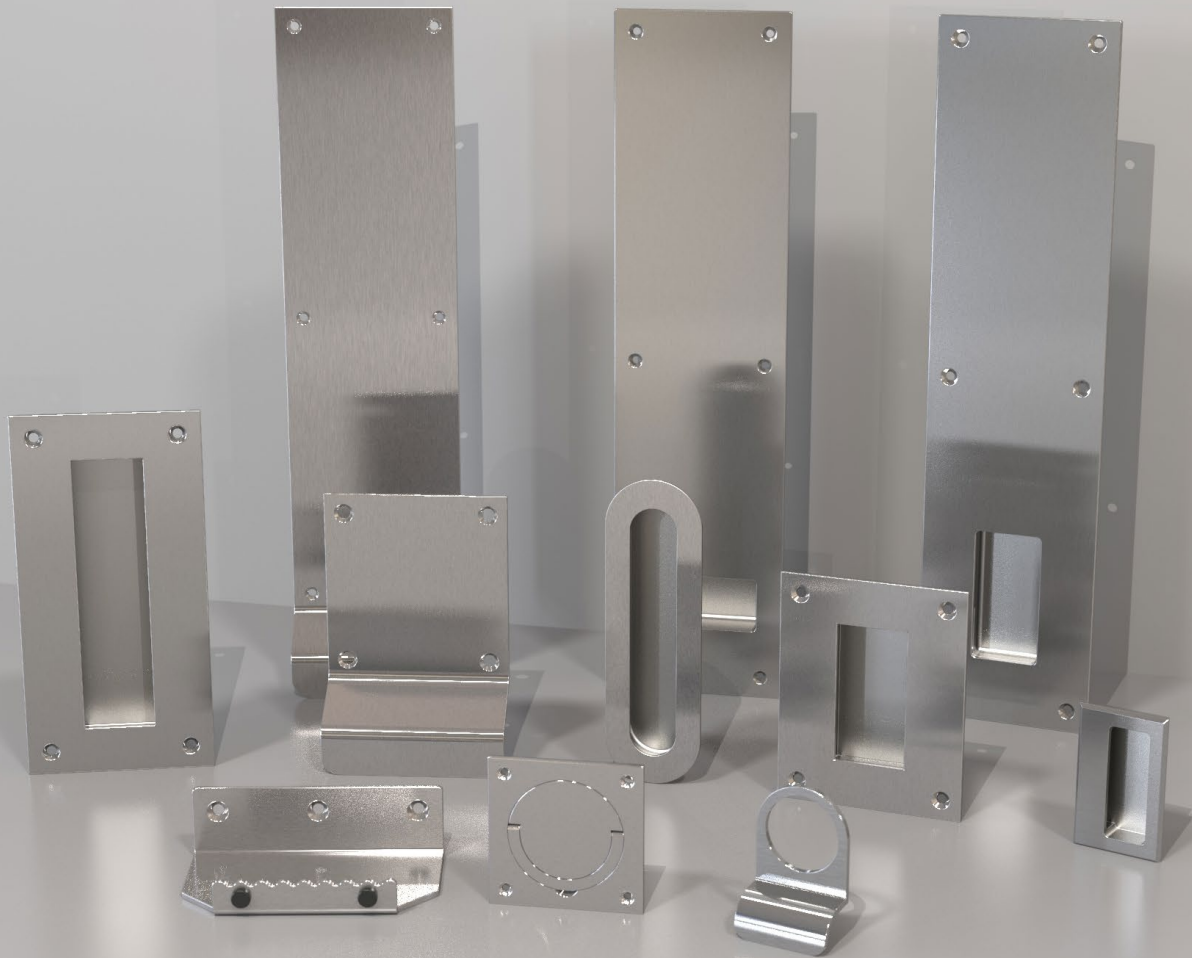

**136** RING PULLS

**137** FLUSH PULLS

**141** CYLINDER PULLS

**143** PULL PLATES

**146** EDGE PULLS

**147** FOOT PULLS





# FLUSH PULLS & PULL PLATES

## RING PULLS

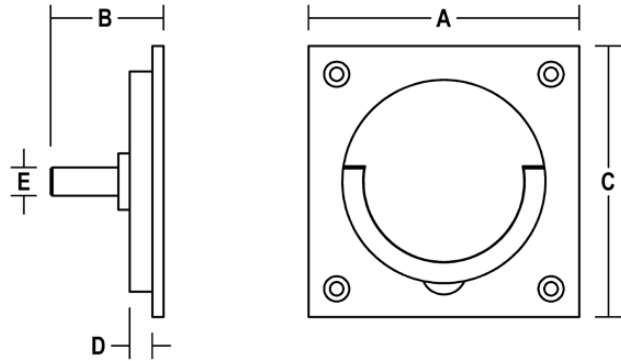

**H400**  
**SQUASH COURT RING PULL**

NO.	A	B	C	D	E
H400	3"	1.375"	3"	0.225"	□ 0.312"

**FEATURED FINISHES:** Satin Chrome (26D)

**FINISHES:** 26D, 32D

**MATERIALS:** Cast Stainless Steel

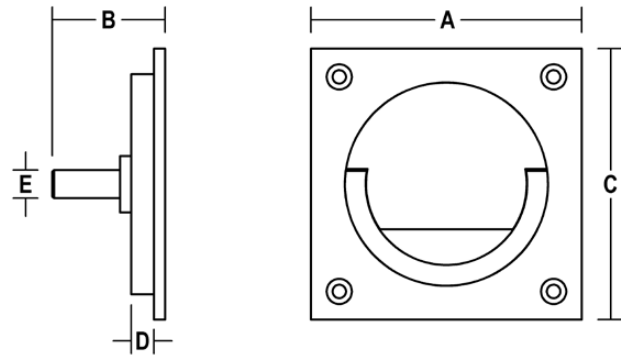

**H401**  
**DROP RING PULL**

NO.	A	B	C	D	E
H401	3"	1.375"	3"	0.225"	□ 0.312"

**FEATURED FINISHES:** Satin Chrome (26D)

**FINISHES:** 26D, 32D

**MATERIALS:** Cast Stainless Steel





# FLUSH PULLS & PULL PLATES

## FLUSH PULLS

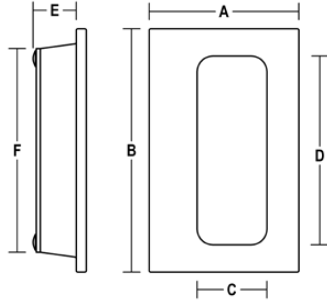

### H402 FLUSH PULL W/ CONCEALED MOUNTING

NO.	A	B	C	D	E	F
H402	1.9375"	3.0625"	0.88"	2.35"	0.55"	1.5" x 2.75"

**FEATURED FINISHES:** Flat Black (19), Satin Chrome (26D), Antimicrobial (AM)

**FINISHES:** 3, 10BE, 19, 26D, PC

**MATERIALS:** Cast Brass, Bronze, Aluminum

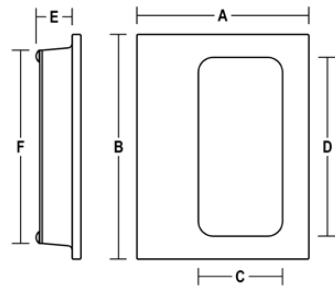

### H403 FLUSH PULL W/ CONCEALED MOUNTING

NO.	A	B	C	D	E	F
H403	2.9062"	3.8125"	1.5"	3"	0.625"	2.5" x 3.5"

**FEATURED FINISHES:** Flat Black (19), Satin Chrome (26D), Antimicrobial (AM)

**FINISHES:** 3, 10BE, 19, 26D, PC

**MATERIALS:** Cast Brass, Bronze, Aluminum

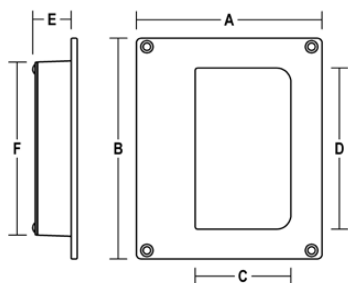

### H404 FLUSH PULL

NO.	A	B	C	D	E	F
H404	3.875"	4.5625"	2.0625"	3.375"	0.75"	3.125" x 3.75"

**FEATURED FINISHES:** Flat Black (19), Satin Chrome (26D), Antimicrobial (AM)

**FINISHES:** 3, 10BE, 19, 26D, PC

**MATERIALS:** Cast Brass, Bronze, Aluminum



# FLUSH PULLS & PULL PLATES

## FLUSH PULLS

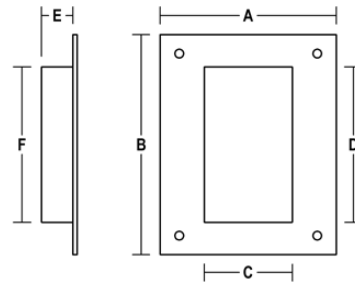

### H406 RECTANGULAR FLUSH PULL

NO.	A	B	C	D	E	F
H406	4"	5"	1.5"	3"	0.875"	2.0625" x 3.25"

**FEATURED FINISHES:** Flat Black (19), Satin Stainless (32D), Antimicrobial (AM)

**FINISHES:** Standard & Custom Available (See Pages 16 & 17)

**MATERIAL:** Stainless Steel

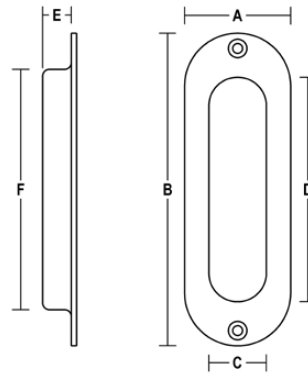

### H428 OVAL FLUSH PULL

NO.	A	B	C	D	E	F
H428	1.625"	4.625"	0.875"	3.375"	0.4375"	1.125" x 3.6875"

**FEATURED FINISHES:** Flat Black (19), Satin Stainless (32D), Antimicrobial (AM)

**FINISHES:** 10BE, 19, 32D, PC

**MATERIAL:** Stainless Steel



# FLUSH PULLS & PULL PLATES

## FLUSH PULLS

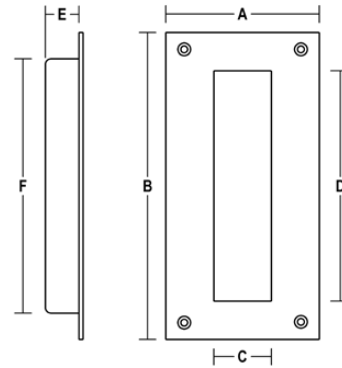
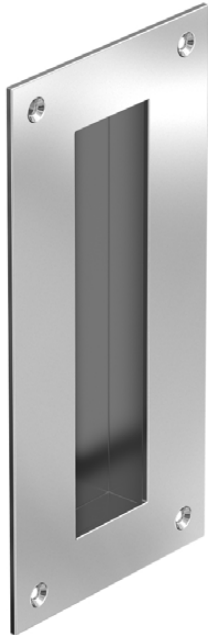

### H429

#### TALL RECTANGULAR FLUSH PULL

NO.	A	B	C	D	E	F
H429	4"	8"	1.5"	6"	0.875"	2.125" x 6.625"

**FEATURED FINISHES:** Flat Black (19), Satin Stainless (32D), Antimicrobial (AM)

**FINISHES:** Standard & Custom Available (See Pages 16 & 17)

**MATERIAL:** Stainless Steel

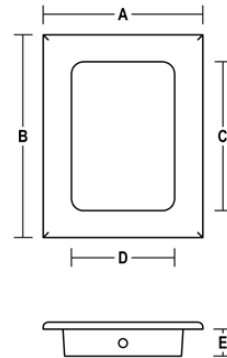

### H485

#### FLUSH PULL W/ CONCEALED MOUNTING

NO.	A	B	C	D	E
H485	3.25"	4.125"	3"	2"	0.5625"

**FEATURED FINISHES:** Flat Black (19), Satin Chrome (26D), Antimicrobial (AM)

**FINISHES:** 10BE, 19, 26D, PC

**MATERIALS:** Cast Brass, Bronze, Aluminum



# FLUSH PULLS & PULL PLATES

## FLUSH PULLS

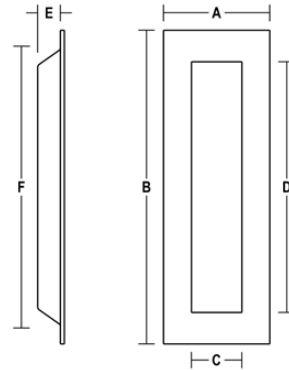

### H462 6" MODERN RECTANGULAR FLUSH PULL

NO.	A	B	C	D	E	F
H462	2"	6"	0.9375"	4.6875"	0.4375"	1.625" x 5.1875"

**FEATURED FINISHES:** Flat Black (19), Satin Stainless (32D),  
Antimicrobial (AM)

**FINISHES:** 10BE, 19, 32D, PC

**MATERIALS:** Stainless Steel

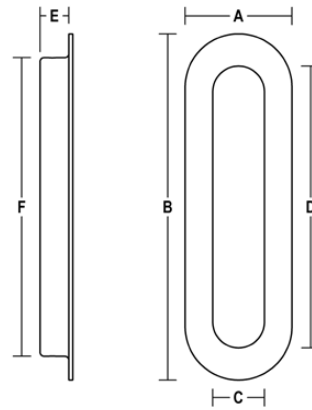
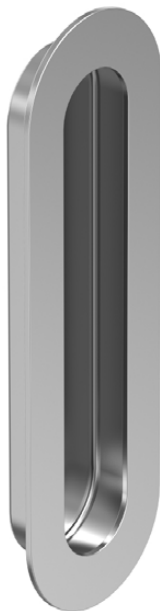

### H472 OVAL FLUSH PULL W/ CONCEALED MOUNTING

NO.	A	B	C	D	E	F
H472	2.25"	6.75"	1"	5.5"	0.5625"	1.5" x 5.875"

**FEATURED FINISHES:** Flat Black (19), Satin Stainless (32D),  
Antimicrobial (AM)

**FINISHES:** 10BE, 19, 32D, PC

**MATERIALS:** Stainless Steel



# FLUSH PULLS & PULL PLATES

## CYLINDER PULLS

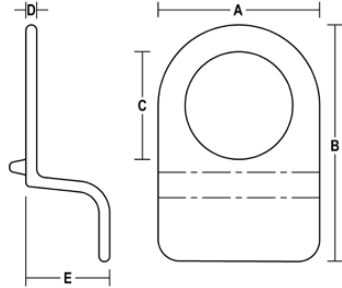

### H407

#### Ø 1-1/4" ROUND CYLINDER PULL

NO.	A	B	C	D	E
H407	1.8125"	2.75"	Ø 1.25"	0.125"	0.9375"

**FEATURED FINISHES:** Flat Black (19), Satin Chrome (26D), Antimicrobial (AM)

**FINISHES:** 3, 10BE, 19, 26D, PC

**MATERIALS:** Cast Brass, Bronze

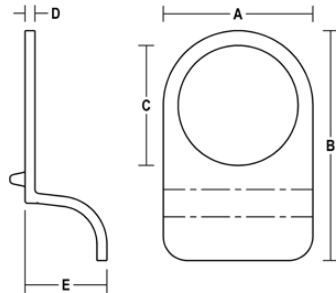
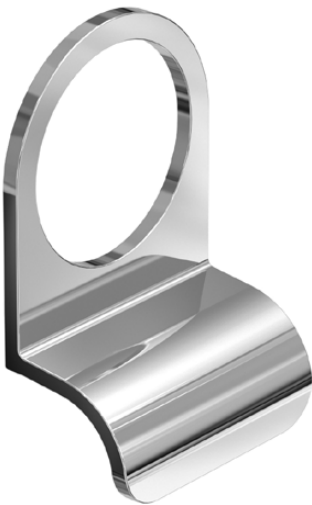

### H408

#### Ø 1-1/2" ROUND CYLINDER PULL

NO.	A	B	C	D	E
H408	1.8125"	2.75"	Ø 1.5"	0.125"	0.9375"

**FEATURED FINISHES:** Flat Black (19), Satin Chrome (26D), Antimicrobial (AM)

**FINISHES:** 3, 10BE, 19, 26D, PC

**MATERIALS:** Cast Brass, Bronze

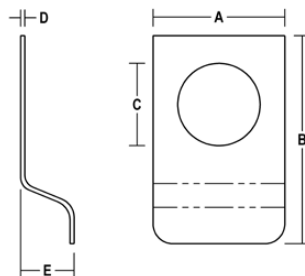

### H409

#### Ø 1-1/4" SQUARE CYLINDER PULL

NO.	A	B	C	D	E
H409	2"	3.125"	Ø 1.25"	0.125"	0.875"

**FEATURED FINISHES:** Flat Black (19), Satin Stainless (32D), Antimicrobial (AM)

**FINISHES:** Standard & Custom Available (See Pages 16 & 17)

**MATERIALS:** Aluminum, Brass, Bronze, Stainless Steel



# FLUSH PULLS & PULL PLATES

## CYLINDER PULLS

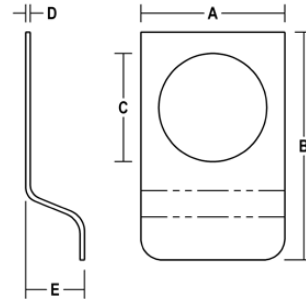

### H410

#### Ø 1-1/2" SQUARE CYLINDER PULL

NO.	A	B	C	D	E
H410	2"	3.125"	Ø 1.5"	0.125"	0.875"

**FEATURED FINISHES:** Flat Black (19), Satin Stainless (32D), Antimicrobial (AM)

**FINISHES:** Standard & Custom Available (See Pages 16 & 17)

**MATERIALS:** Aluminum, Brass, Bronze, Stainless Steel

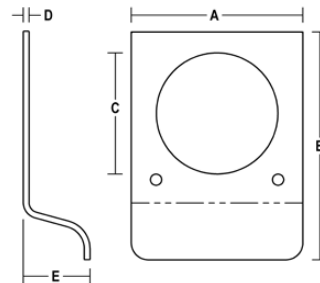

### H411

#### Ø 2-1/8" SQUARE CYLINDER PULL

NO.	A	B	C	D	E
H411	3"	4"	Ø 2.125"	0.125"	0.875"

**FEATURED FINISHES:** Flat Black (19), Satin Stainless (32D), Antimicrobial (AM)

**FINISHES:** Standard & Custom Available (See Pages 16 & 17)

**MATERIALS:** Aluminum, Brass, Bronze, Stainless Steel



# FLUSH PULLS & PULL PLATES

## PULL PLATES

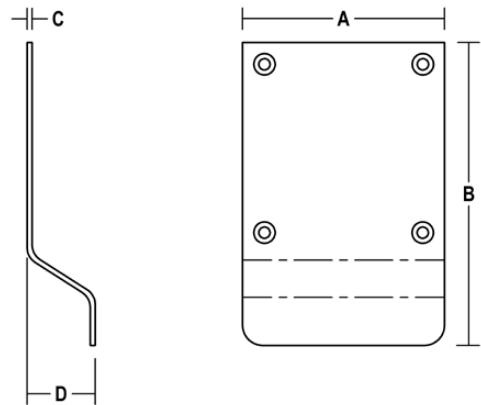

### H412 6" PULL PLATE

NO.	A	B	C	D
H412	4"	6"	0.125"	1.125"

**FEATURED FINISHES:** Flat Black (19), Satin Stainless (32D), Antimicrobial (AM)

**FINISHES:** Standard & Custom Available (See Pages 16 & 17)

**MATERIALS:** Aluminum, Brass, Bronze, Stainless Steel



# FLUSH PULLS & PULL PLATES

## PULL PLATES

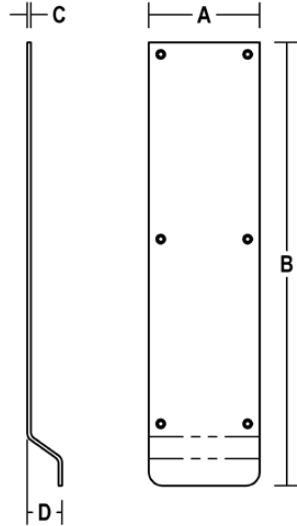

### H413 16" PULL PLATE

NO.	A	B	C	D
H413	4"	16"	0.125"	1.125"

**FEATURED FINISHES:** Flat Black (19), Satin Stainless (32D), Antimicrobial (AM)

**FINISHES:** Standard & Custom Available (See Pages 16 & 17)

**MATERIALS:** Aluminum, Brass, Bronze, Stainless Steel

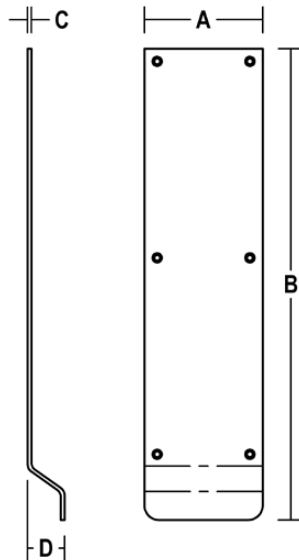

### H414 20" PULL PLATE

NO.	A	B	C	D
H414	4"	20"	0.125"	1.125"

**FEATURED FINISHES:** Flat Black (19), Satin Stainless (32D), Antimicrobial (AM)

**FINISHES:** Standard & Custom Available (See Pages 16 & 17)

**MATERIALS:** Aluminum, Brass, Bronze, Stainless Steel





# FLUSH PULLS & PULL PLATES

## PULL PLATES

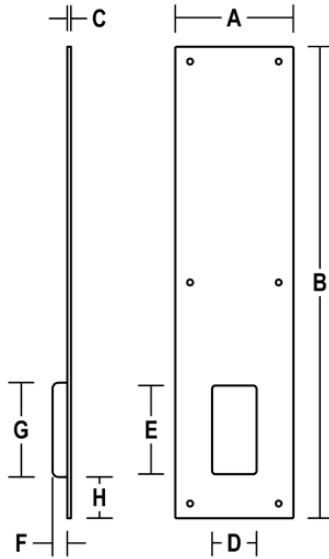

### H415 PULL PLATE

NO.	A	B	C	D	E	F	G	H
H415	4"	16"	0.125"	1.5"	3"	0.875"	2.0625" x 3.25"	1.5"

**FEATURED FINISHES:** Flat Black (19), Satin Stainless (32D),  
Antimicrobial (AM)

**FINISHES:** Standard & Custom Available (See Pages 16 & 17)

**MATERIAL:** Stainless Steel

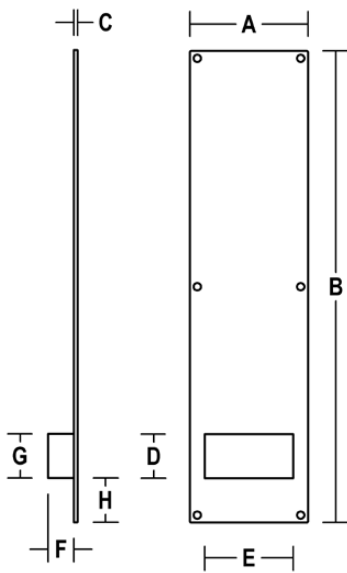

### H416 PULL PLATE

NO.	A	B	C	D	E	F	G	H
H416	4"	16"	0.125"	1.5"	3"	0.875"	2.0625" x 3.25"	1.5"

**FEATURED FINISHES:** Flat Black (19), Satin Stainless (32D),  
Antimicrobial (AM)

**FINISHES:** Standard & Custom Available (See Pages 16 & 17)

**MATERIAL:** Stainless Steel



# FLUSH PULLS & PULL PLATES

## EDGE PULL

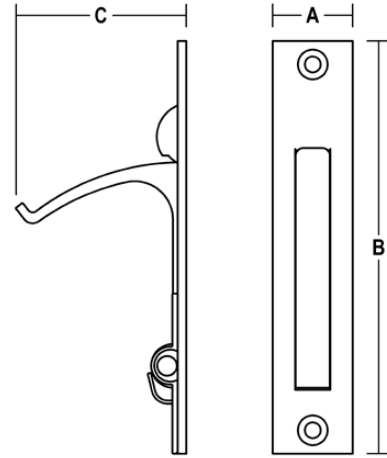

### H426 EDGE PULL

NO.	A	B	C
H426	0.75"	3.875"	1.6875"

**FEATURED FINISHES:** Satin Chrome (26D)

**FINISHES:** 3, 10BE, 19, 26D, PC

**MATERIALS:** Brass



# FLUSH PULLS & PULL PLATES

## FOOT PULLS

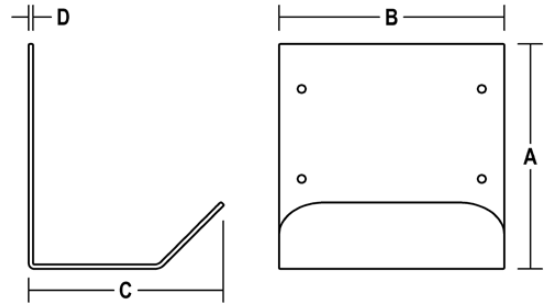

### H435 FOOT PULL

NO.	A	B	C	D
H435	5"	5"	4.375"	0.1"

**FEATURED FINISHES:** Flat Black (19), Satin Stainless (32D), Antimicrobial (AM)

**FINISHES:** Standard & Custom Available (See Pages 16 & 17)

**MATERIAL:** Stainless Steel

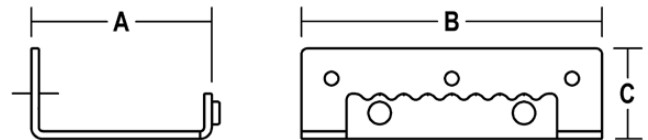

### H444 STEP PULL

NO.	A	B	C	D
H444	3"	5"	1.5"	0.125"

**FEATURED FINISHES:** Flat Black (19), Satin Stainless (32D), Antimicrobial (AM)

**FINISHES:** Standard & Custom Available (See Pages 16 & 17)

**MATERIAL:** Stainless Steel



# PROTECTION PLATES

---



**150** KICK PLATES

**152** ANGLE PLATES

**154** U-CHANNELS

**156** PUSH PLATES

**159** CAST PUSH PLATES





# PROTECTION PLATES

## KICK PLATES

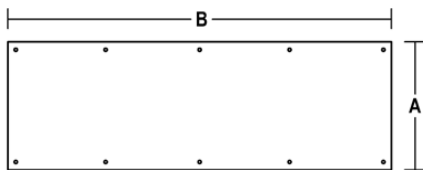

### K08 CLEAR ACRYLIC PLATE

NO.	A	B
K08	SPECIFY	SPECIFY

**MATERIAL:** Clear Acrylic

**NOTES:** 0.125" Thickness, Beveled Edges, Countersunk Screw Holes

**MOUNTING OPTIONS:** SMS (**Standard**), MS, TEK (SDS), Torx, Tape, No Holes/No Tape (Recommended)

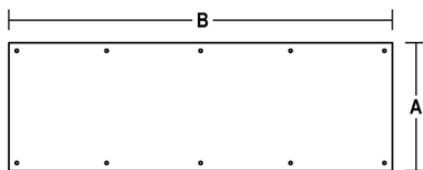

### K09 KYDEX PLATE

NO.	A	B (GRAIN DIRECTION)
K09	SPECIFY	SPECIFY

**MATERIAL:** Kydex

**NOTES:** PVC & Acrylic Textured Finish, 0.060 Thickness, Beveled Edges

**MOUNTING OPTIONS:** SMS (**Standard**), MS, TEK (SDS), Torx, Tape, No Holes/No Tape (Recommended)

**PRODUCT OPTIONS:** Over 30 Colours Available

**STOCK COLOURS:** Black, Beige, Blue, Grey, & White



# PROTECTION PLATES

## KICK PLATES

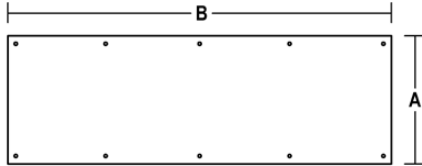

### K10 METAL DOOR PLATE

NO.	A	B (GRAIN DIRECTION)
K10	SPECIFY	SPECIFY

**FEATURED FINISHES:** Flat Black (19), Satin Stainless (32D), Antimicrobial (AM)

**FINISHES:** Standard & Custom Available (See Pages 16 & 17)

**MATERIALS:** Aluminum, Brass, Bronze, Stainless Steel

**NOTES:** Countersunk Screw Holes, Protective Plastic Film

**MOUNTING OPTIONS:** SMS (**Standard**), MS, TEK (SDS), Torx, Tape, No Holes/No Tape

**PRODUCT OPTIONS:**

- **FIRE RATED 18GA AVAILABLE:** Use suffix code F (K10F)
- **MATERIAL THICKNESS:** K10A = 0.050", K10B = 0.062", K10C = 0.10"
- **ESCUTCHEON CUT OUTS:** Specify hole diameter and location
- **ENGRAVING:** Specify type and location

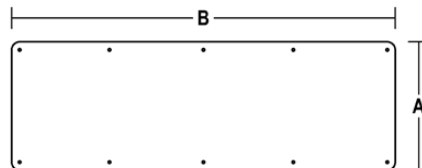
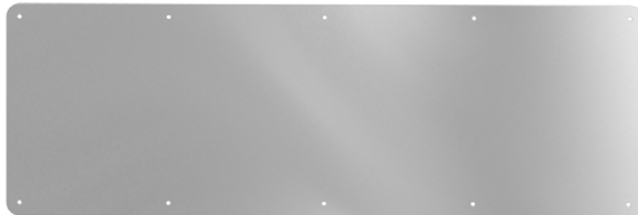

### K10R METAL DOOR PLATE W/ RADIUS CORNERS

NO.	A	B (GRAIN DIRECTION)
K10R	SPECIFY	SPECIFY

**FEATURED FINISHES:** Flat Black (19), Satin Stainless (32D), Antimicrobial (AM)

**FINISHES:** Standard & Custom Available (See Pages 16 & 17)

**MATERIALS:** Aluminum, Brass, Bronze, Stainless Steel

**NOTES:** Countersunk Screw Holes, Protective Plastic Film

**MOUNTING OPTIONS:** SMS (**Standard**), MS, TEK (SDS), Torx, Tape, No Holes/No Tape

**PRODUCT OPTIONS:**

- **FIRE RATED 18GA AVAILABLE:** Use suffix code F (K10RF)
- **MATERIAL THICKNESS:** K10A = 0.050", K10B = 0.062", K10C = 0.10"
- **ESCUTCHEON CUT OUTS:** Specify hole diameter and location
- **ENGRAVING:** Specify type and location



# PROTECTION PLATES

## ANGLE PLATES

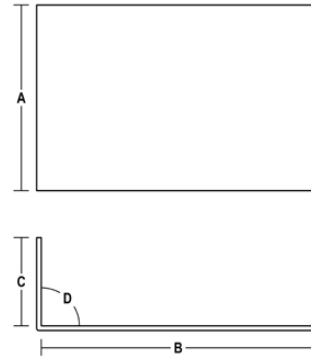
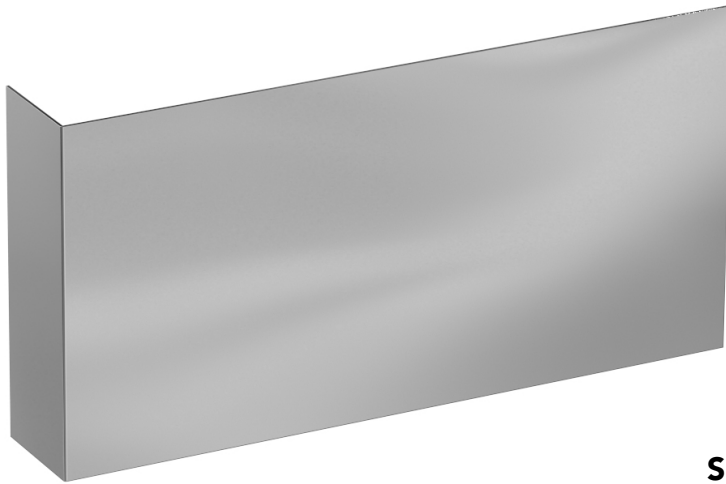

**K32**  
**SINGLE SIDE ANGLE PLATE**

NO.	A	B	C	D
<b>K32</b>	SPECIFY	SPECIFY (ID)	SPECIFY (ID)	SPECIFY

**FEATURED FINISHES:** Flat Black (19), Satin Stainless (32D)

**FINISHES:** Standard & Custom Available (See Pages 16 & 17)

**MATERIALS:** Aluminum, Brass, Bronze, Stainless Steel

**PRODUCT OPTIONS:** Lock and Hinge Cutouts Available (Specify Size and Location)

**MOUNTING OPTIONS:** SMS (**Standard**), MS, TEK (SDS), Torx, Tape, No Holes/No Tape

**NOTES:** Specify Door Thickness • Specify Door Width • Custom sizes available • Comes Standard with Countersunk Holes for Screw MTG & Protective Plastic Film

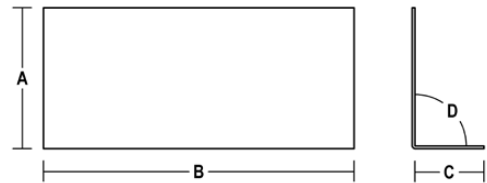
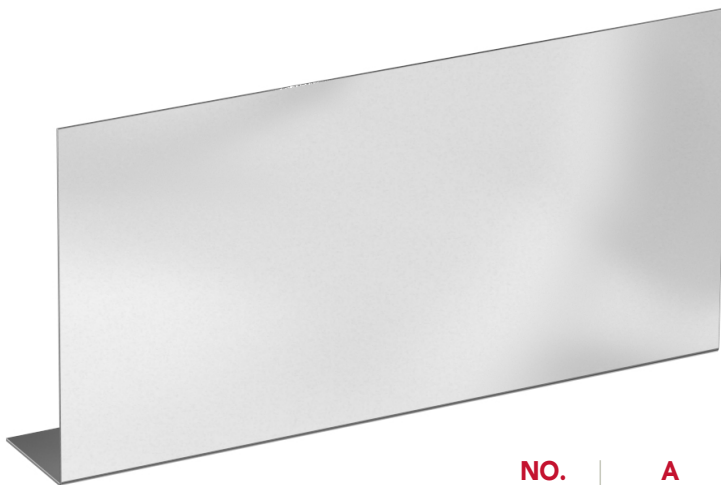

**K33**  
**BOTTOM ANGLE PLATE**

NO.	A	B	C	D
<b>K33</b>	SPECIFY	SPECIFY	SPECIFY (ID)	SPECIFY

**FEATURED FINISHES:** Flat Black (19), Satin Stainless (32D)

**FINISHES:** Standard & Custom Available (See Pages 16 & 17)

**MATERIALS:** Aluminum, Brass, Bronze, Stainless Steel

**PRODUCT OPTIONS:** Lock and Hinge Cutouts Available (Specify Size and Location)

**MOUNTING OPTIONS:** SMS (**Standard**), MS, TEK (SDS), Torx, Tape, No Holes/No Tape

**NOTES:** Specify Door Thickness • Specify Door Width • Custom sizes available • Comes Standard with Countersunk Holes for Screw MTG & Protective Plastic Film





# PROTECTION PLATES

## ANGLE PLATES

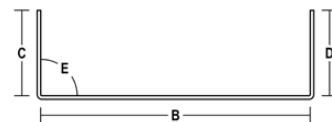
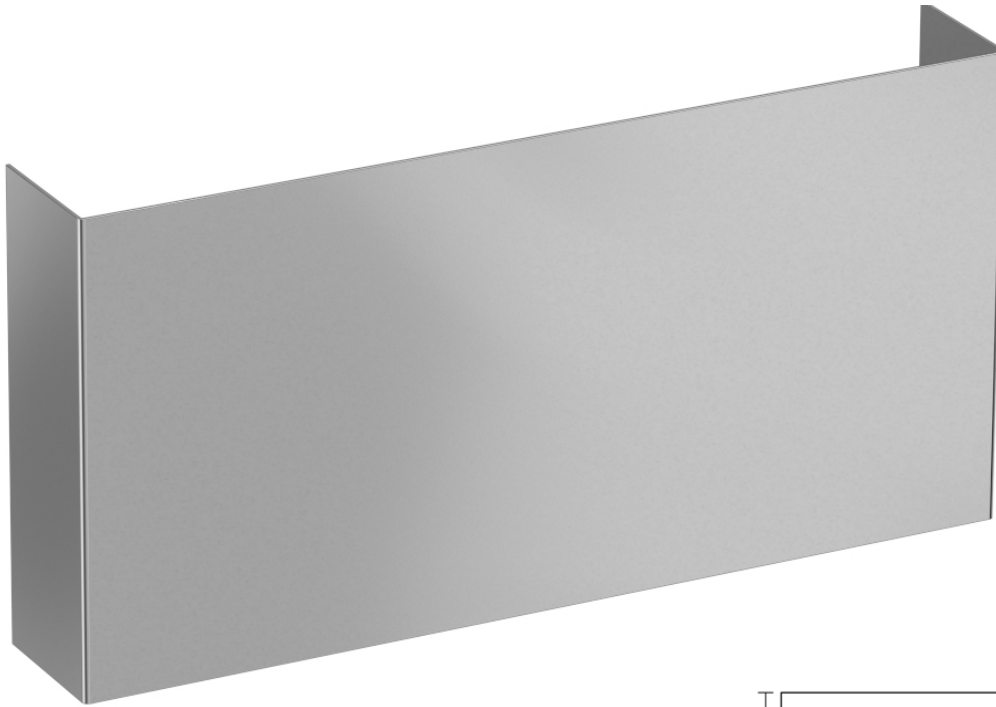

### K34 DOUBLE SIDE ANGLE PLATE

NO.	A	B	C	D	E
K34	SPECIFY	SPECIFY (ID)	SPECIFY (ID)	SPECIFY (ID)	SPECIFY

**FEATURED FINISHES:** Flat Black (19), Satin Stainless (32D)

**FINISHES:** Standard & Custom Available (See Pages 16 & 17)

**MATERIALS:** Aluminum, Brass, Bronze, Stainless Steel

**PRODUCT OPTIONS:** Lock and Hinge Cutouts Available (Specify Size and Location)

**MOUNTING OPTIONS:** SMS (**Standard**), MS, TEK (SDS), Torx, Tape, No Holes/No Tape

**NOTES:** Specify Door Thickness • Specify Door Width • Custom sizes available • Comes Standard with Countersunk Holes for Screw MTG & Protective Plastic Film



# PROTECTION PLATES

## U-CHANNELS

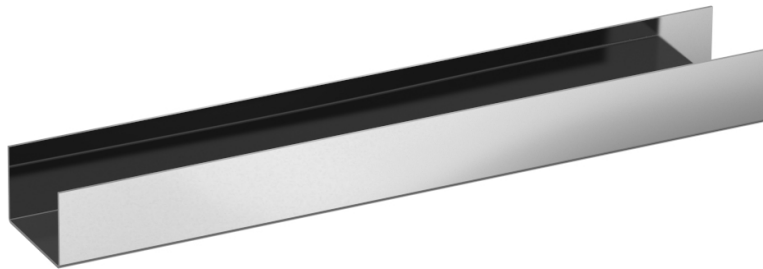

### K30 U-CHANNEL

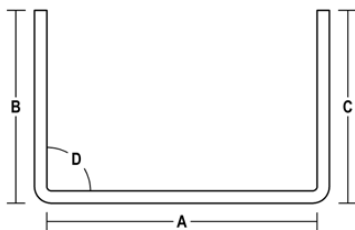

NO.	A	B	C	D
K30	1.75" (ID)	1.25"	1.25"	90°

**FEATURED FINISHES:** Flat Black (19), Satin Stainless (32D)

**FINISHES:** Standard & Custom Available (See Pages 16 & 17)

**MATERIALS:** Aluminum, Brass, Bronze, Stainless Steel, Kydex

**MOUNTING OPTIONS:** SMS (**Standard**), MS, TEK (SDS), Torx, Tape, No Holes/No Tape

**NOTES:** Used for Door Bottom • Specify Door Thickness • Specify Door Width •

Custom sizes available • Comes Standard with Countersunk Holes for Screw MTG & Protective Plastic Film



# PROTECTION PLATES

## U-CHANNELS



### K31

#### U-CHANNEL W/ KICKPLATE EXTENSION

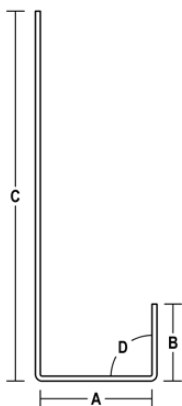

NO.	A	B	C	D
K31	1.75" (ID)	1.25"	SPECIFY	90°

**FEATURED FINISHES:** Flat Black (19), Satin Stainless (32D)

**FINISHES:** Standard & Custom Available (See Pages 16 & 17)

**MATERIALS:** Aluminum, Brass, Bronze, Stainless Steel, Kydex

**MOUNTING OPTIONS:** SMS (**Standard**), MS, TEK (SDS), Torx, Tape, No Holes/No Tape

**NOTES:** Used for Door Bottom • Specify Door Thickness • Specify Door Width • Custom sizes available • Comes Standard with Countersunk Holes for Screw MTG & Protective Plastic Film

**PRODUCT OPTIONS:**

- **FIRE RATED 18GA AVAILABLE:** Use suffix code F (K31F)



# PROTECTION PLATES

## PUSH PLATES

### K11 METAL PUSH PLATE

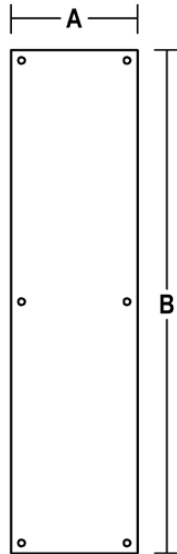
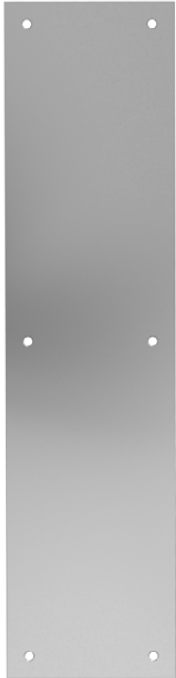

NO.	A	B (GRAIN DIRECTION)
K11	SPECIFY	SPECIFY
K11A-1	3"	12"
K11A-2	3.5"	15"
K11A-3	4"	16"
K11A-4	4"	20"
K11A-5	5"	15"
K11A-6	5"	20"
K11F (FEMALE)	5"	20"
K11H (WHEEL CHAIR)	5"	20"
K11M (MALE)	5"	20"

**FEATURED FINISHES:** Flat Black (19), Satin Stainless (32D), Antimicrobial (AM)

**FINISHES:** Standard & Custom Available (See Pages 16 & 17)

**MATERIALS:** Aluminum, Brass, Bronze, Stainless Steel

**NOTES:** Countersunk Screw Holes, Protective Plastic Film, Custom Sizes Available

**MOUNTING OPTIONS:** SMS (**Standard**), MS, TEK (SDS), Torx, Tape, No Holes/No Tape

**PRODUCT OPTIONS:**

- **MATERIAL THICKNESS:** K11A = 0.050" , K11B = 0.062" , K11C = 0.10"
- **ESCUTCHEON CUT OUTS:** Specify hole diameter and location
- **ENGRAVING:** Specify type and location
- **FIRE RATED 18GA AVAILABLE:** Use suffix code F (K11F)

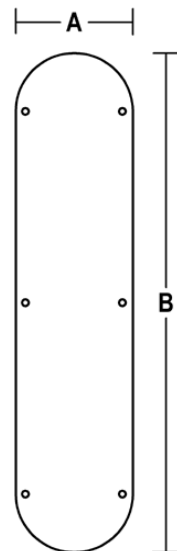
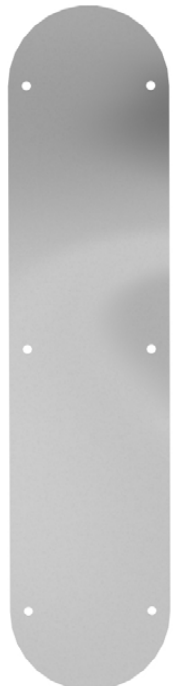

### K12 METAL PUSH PLATE W/ ROUND ENDS

NO.	A	B (GRAIN DIRECTION)
K12	SPECIFY	SPECIFY

**FEATURED FINISHES:** Flat Black (19), Satin Stainless (32D), Antimicrobial (AM)

**FINISHES:** Standard & Custom Available (See Pages 16 & 17)

**MATERIALS:** Aluminum, Brass, Bronze, Stainless Steel

**NOTES:** Countersunk Screw Holes, Protective Plastic Film

**MOUNTING OPTIONS:** SMS (**Standard**), MS, TEK (SDS), Torx, Tape, No Holes/No Tape

**PRODUCT OPTIONS:**

- **MATERIAL THICKNESS:** K12A = 0.050" , K12B = 0.062" , K12C = 0.10"
- **ESCUTCHEON CUT OUTS:** Specify hole diameter and location
- **ENGRAVING:** Specify type and location
- **FIRE RATED 18GA AVAILABLE:** Use suffix code F (K12F)



# PROTECTION PLATES

## PUSH PLATES

### K13

#### SEMI-CIRCULAR METAL PUSH PLATE

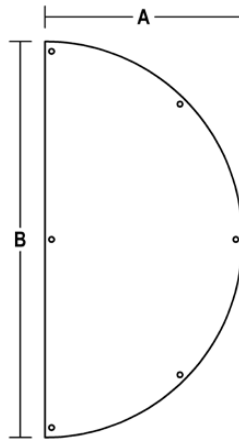
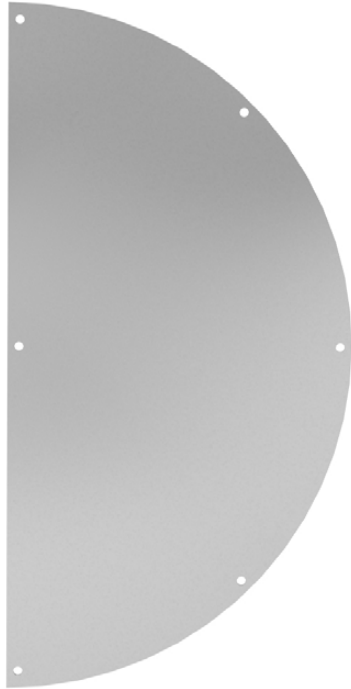

NO.	A	B (GRAIN DIRECTION)
K13	SPECIFY	SPECIFY

**FEATURED FINISHES:** Flat Black (19), Satin Stainless (32D), Antimicrobial (AM)

**FINISHES:** Standard & Custom Available (See Pages 16 & 17)

**MATERIALS:** Aluminum, Brass, Bronze, Stainless Steel

**NOTES:** Countersunk Screw Holes, Protective Plastic Film

**MOUNTING OPTIONS:** SMS (**Standard**), MS, TEK (SDS), Torx, Tape, No Holes/No Tape

**PRODUCT OPTIONS:**

- **MATERIAL THICKNESS:** K13A = 0.050", K13B = 0.062", K13C = 0.10"
- **ESCUTCHEON CUT OUTS:** Specify hole diameter and location
- **ENGRAVING:** Specify type and location
- **FIRE RATED 18GA AVAILABLE:** Use suffix code F (K13F)

### K14

#### METAL PUSH PLATE W/ ROUNDED CORNERS

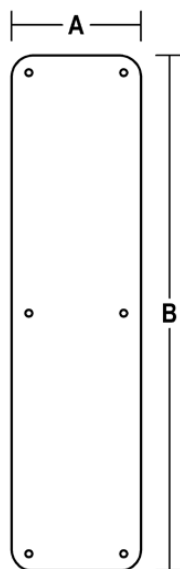

NO.	A	B (GRAIN DIRECTION)
K14	SPECIFY	SPECIFY
K14A-1	3"	12"
K14A-2	3.5"	15"
K14A-3	4"	16"
K14A-4	4"	20"
K14A-5	5"	15"
K14A-6	5"	20"

**FEATURED FINISHES:** Flat Black (19), Satin Stainless (32D), Antimicrobial (AM)

**FINISHES:** Standard & Custom Available (See Pages 16 & 17)

**MATERIALS:** Aluminum, Brass, Bronze, Stainless Steel

**NOTES:** Countersunk Screw Holes, Protective Plastic Film

**MOUNTING OPTIONS:** SMS (**Standard**), MS, TEK (SDS), Torx, Tape, No Holes/No Tape

**PRODUCT OPTIONS:**

- **MATERIAL THICKNESS:** K14A = 0.050", K14B = 0.062", K14C = 0.10"
- **ESCUTCHEON CUT OUTS:** Specify hole diameter and location
- **ENGRAVING:** Specify type and location
- **FIRE RATED 18GA AVAILABLE:** Use suffix code F (K14F)



# PROTECTION PLATES

## PUSH PLATES

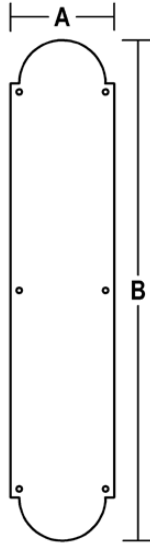

### K15

#### COLONIAL METAL PUSH PLATE

NO.	A	B (GRAIN DIRECTION)
K15	SPECIFY	SPECIFY

**FEATURED FINISHES:** Flat Black (19), Satin Stainless (32D), Antimicrobial (AM)

**FINISHES:** Standard & Custom Available (See Pages 16 & 17)

**MATERIALS:** Aluminum, Brass, Bronze, Stainless Steel

**NOTES:** Countersunk Screw Holes, Protective Plastic Film

**MOUNTING OPTIONS:** SMS (**Standard**), MS, TEK (SDS), Torx, Tape, No Holes/No Tape

**PRODUCT OPTIONS:**

- **MATERIAL THICKNESS:** K15A = 0.050" , K15B = 0.062" , K15C = 0.10"
- **ESCUTCHEON CUT OUTS:** Specify hole diameter and location
- **ENGRAVING:** Specify type and location
- **FIRE RATED 18GA AVAILABLE:** Use suffix code F (K15F)

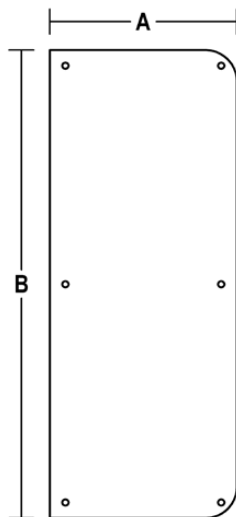
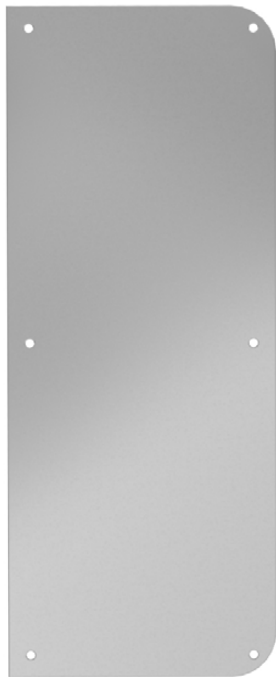

### K16

#### D-SHAPE METAL PUSH PLATE

NO.	A	B (GRAIN DIRECTION)
K16	SPECIFY	SPECIFY
K16A-1	3"	12"
K16A-2	3.5"	15"
K16A-3	4"	16"
K16A-4	4"	20"
K16A-5	5"	15"
K16A-6	5"	20"

**FEATURED FINISHES:** Flat Black (19), Satin Stainless (32D), Antimicrobial (AM)

**FINISHES:** Standard & Custom Available (See Pages 16 & 17)

**MATERIALS:** Aluminum, Brass, Bronze, Stainless Steel

**NOTES:** Countersunk Screw Holes, Protective Plastic Film

**MOUNTING OPTIONS:** SMS (**Standard**), MS, TEK (SDS), Torx, Tape, No Holes/No Tape

**PRODUCT OPTIONS:**

- **MATERIAL THICKNESS:** K16A = 0.050" , K16B = 0.062" , K16C = 0.10"
- **ESCUTCHEON CUT OUTS:** Specify hole diameter and location
- **ENGRAVING:** Specify type and location
- **FIRE RATED 18GA AVAILABLE:** Use suffix code F (K16F)



# PROTECTION PLATES

## CAST PUSH PLATES

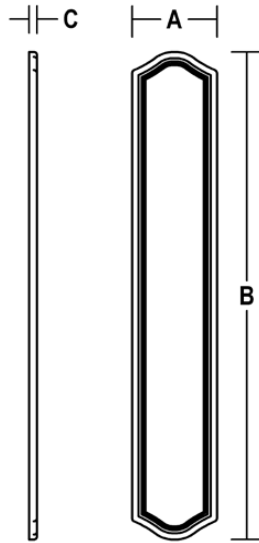

### K17 CAST PUSH PLATE

NO.	A	B	C
K17	2.625"	15.5"	0.25"

**FEATURED FINISHES:** Flat Black (19), Antimicrobial (AM)

**FINISHES:** Standard & Custom Available (See Pages 16 & 17)

**MATERIALS:** Cast Brass, Bronze

**NOTES:** Countersunk Screw Holes

**MOUNTING OPTIONS:** SMS (**Standard**), MS, TEK (SDS), Torx, Tape, No Holes/No Tape

**PRODUCT OPTIONS:** ESCUTCHEON CUT OUTS: Specify hole diameter and location • ENGRAVING: Specify type and location

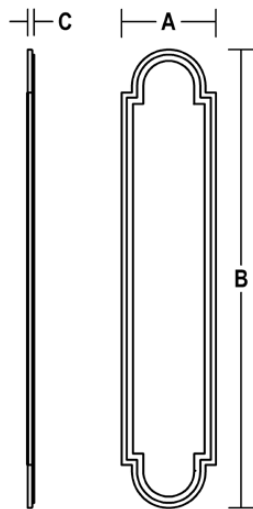

### K22 CAST PUSH PLATE

NO.	A	B	C
K22	3.75"	18.25"	0.25"

**FEATURED FINISHES:** Flat Black (19), Antimicrobial (AM)

**FINISHES:** Standard & Custom Available (See Pages 16 & 17)

**MATERIALS:** Cast Brass, Bronze

**NOTES:** Countersunk Screw Holes

**MOUNTING OPTIONS:** SMS (**Standard**), MS, TEK (SDS), Torx, Tape, No Holes/No Tape

**PRODUCT OPTIONS:** ESCUTCHEON CUT OUTS: Specify hole diameter and location • ENGRAVING: Specify type and location



# ENGRAVINGS, CUTOUTS & ESCUTCHEON PLATES

WE OFFER CUSTOM ENGRAVING AND CUTOUTS FOR ALL OF OUR DOOR PLATES

## ENGRAVINGS

- Numbers, letters, pictos and logos available
- Standard font is 1" single stroke (Other fonts and sizes available upon request)
- Engraving comes standard laser engraved  
(Paint filled in black or other colours available upon request)
- Available in all materials and finishes
- Available with braille translation

## STANDARD ENGRAVING CODES

**(MALE PICTO)** = Use suffix code "M" to your product code — ex. K12M

**(FEMALE PICTO)** = Use suffix code "F" to your product code — ex. K11F

**(WHEELCHAIR PICTO)** = Use suffix code "H" to your product code — ex. K14H

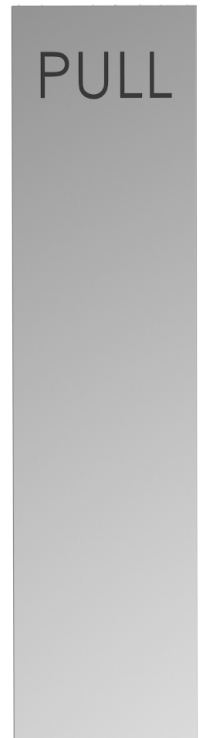





# ENGRAVINGS, CUTOUTS & ESCUTCHEON PLATES

WE OFFER CUSTOM ENGRAVING AND CUTOUTS FOR ALL OF OUR DOOR PLATES

## CUTOUTS

- Custom cutouts available in any size or shape
- Provide size and location of cutout
- Available in all materials and finishes

## ESCUTCHEONS

- Provide hole cutout details including diameter and location
- Provide engraving details (see Engravings details for available options)
- Available in all materials and finishes

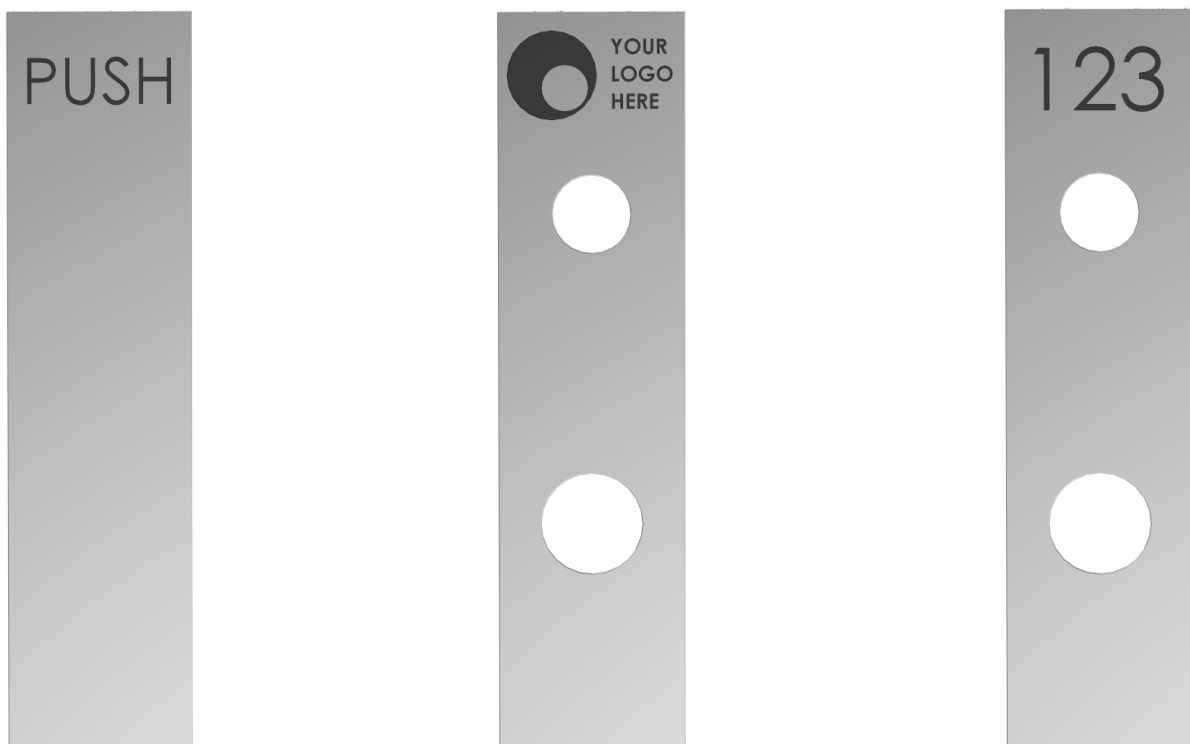

EMPLOYEES ONLY



# GUARDS & ASTRAGALS

---

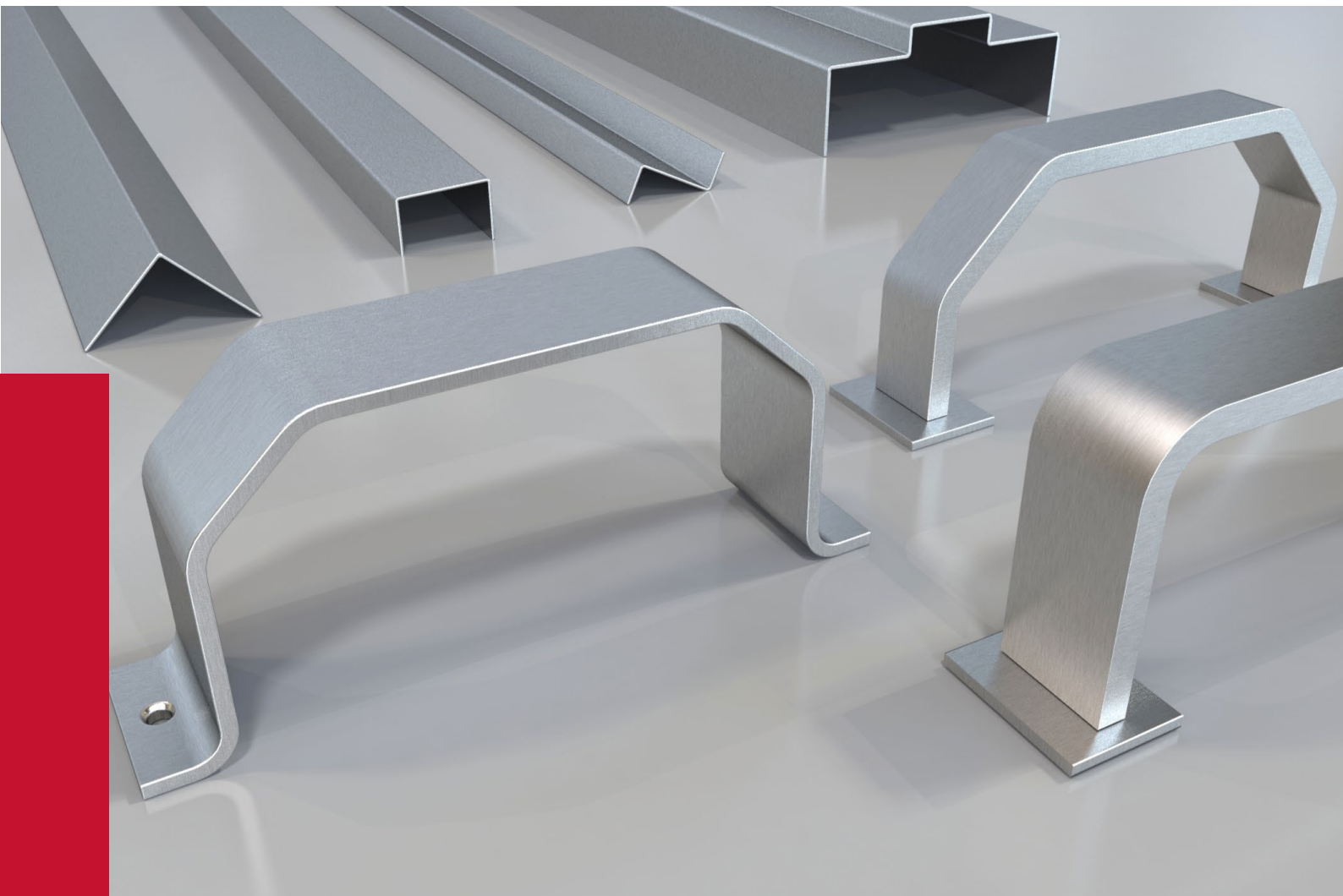

**164** EDGE GUARDS

**168** CORNER GUARDS

**169** ASTRAGALS

**172** FRAME GUARDS

**174** TRIM GUARDS





# GUARDS & ASTRAGALS

## EDGE GUARDS

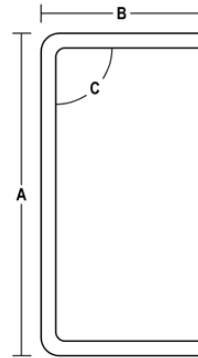

### K37

#### 90° MORTISE EDGE GUARD

NO.	A	B	C
K37	1.75" (OD)	0.875"	90°

**FEATURED FINISHES:** Flat Black (19), Satin Stainless (32D)

**FINISHES:** Standard & Custom Available (See Pages 16 & 17)

**MATERIALS:** Aluminum, Brass, Bronze, Stainless Steel

**PRODUCT OPTIONS:** Cutouts Available (Complete PDF Form to Specify),

**FIRE RATED 18GA AVAILABLE:** Use suffix code F (K37F)

**MOUNTING OPTIONS:** SMS (**Standard**), MS, TEK (SDS), Torx, Tape, No Holes/No Tape

**NOTES:** Complete PDF Form to Specify Cutouts • Custom sizes available • Comes Standard with Countersunk Holes for Screw MTG & Protective Plastic Film

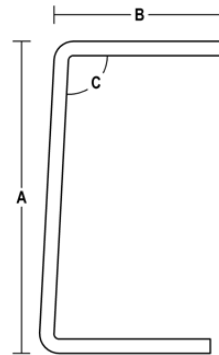

### K38

#### 93° MORTISE EDGE GUARD

NO.	A	B	C
K38	1.75" (OD)	0.875"	93°

**MATERIALS:** Aluminum, Brass, Bronze, Stainless Steel

**FEATURED FINISHES:** Flat Black (19), Satin Stainless (32D)

**PRODUCT OPTIONS:** Cutouts Available (Complete PDF Form to Specify),

**FIRE RATED 18GA AVAILABLE:** Use suffix code F (K38F)

**MOUNTING OPTIONS:** SMS (**Standard**), MS, TEK (SDS), Torx, Tape, No Holes/No Tape

**NOTES:** Complete PDF Form to Specify Cutouts • Custom sizes available • Comes Standard with Countersunk Holes for Screw MTG & Protective Plastic Film



# GUARDS & ASTRAGALS

## EDGE GUARDS

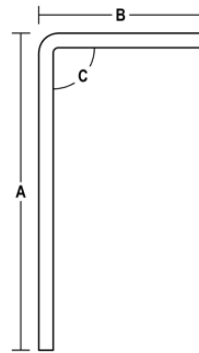

### K39

#### 90° MORTISE EDGE GUARD - HALF

NO.	A	B	C
K39	1.75" (OD)	0.875"	90°

**FEATURED FINISHES:** Flat Black (19), Satin Stainless (32D)

**FINISHES:** Standard & Custom Available (See Pages 16 & 17)

**MATERIALS:** Aluminum, Brass, Bronze, Stainless Steel

**PRODUCT OPTIONS:** Cutouts Available (Complete PDF Form to Specify),

**FIRE RATED 18GA AVAILABLE:** Use suffix code F (K39F)

**MOUNTING OPTIONS:** SMS (**Standard**), MS, TEK (SDS), Torx, Tape, No Holes/No Tape

**NOTES:** Complete PDF Form to Specify Cutouts • Custom sizes available • Comes Standard with Countersunk Holes for Screw MTG & Protective Plastic Film

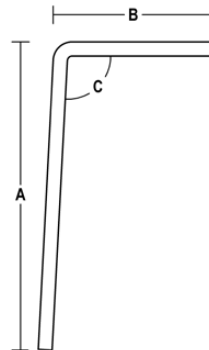

### K40

#### 93° MORTISE EDGE GUARD - HALF

NO.	A	B	C
K40	1.75" (OD)	0.875"	93°

**FEATURED FINISHES:** Flat Black (19), Satin Stainless (32D)

**FINISHES:** Standard & Custom Available (See Pages 16 & 17)

**MATERIALS:** Aluminum, Brass, Bronze, Stainless Steel

**PRODUCT OPTIONS:** Cutouts Available (Complete PDF Form to Specify),

**FIRE RATED 18GA AVAILABLE:** Use suffix code F (K40F)

**MOUNTING OPTIONS:** SMS (**Standard**), MS, TEK (SDS), Torx, Tape, No Holes/No Tape

**NOTES:** Complete PDF Form to Specify Cutouts • Custom sizes available • Comes Standard with Countersunk Holes for Screw MTG & Protective Plastic Film



# GUARDS & ASTRAGALS

## EDGE GUARDS

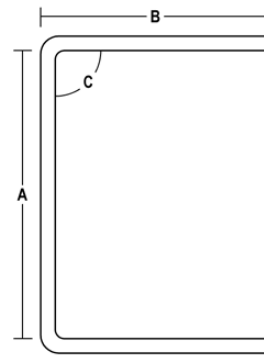

### K41

#### 90° SURFACE EDGE GUARD

NO.	A	B	C
K41	1.75" (ID)	1.25"	90°

**FEATURED FINISHES:** Flat Black (19), Satin Stainless (32D)

**FINISHES:** Standard & Custom Available (See Pages 16 & 17)

**MATERIALS:** Aluminum, Brass, Bronze, Stainless Steel

**PRODUCT OPTIONS:** Cutouts Available (Complete PDF Form to Specify),

**FIRE RATED 18GA AVAILABLE:** Use suffix code F (K41F)

**MOUNTING OPTIONS:** SMS (**Standard**), MS, TEK (SDS), Torx, Tape, No Holes/No Tape

**NOTES:** Complete PDF Form to Specify Cutouts • Custom sizes available • Comes Standard with Countersunk Holes for Screw MTG & Protective Plastic Film

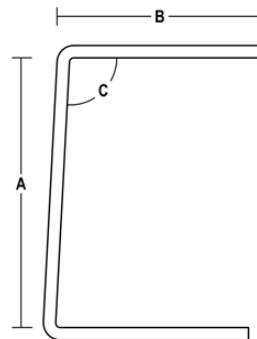

### K42

#### 93° SURFACE EDGE GUARD

NO.	A	B	C
K42	1.75" (ID)	1.25"	93°

**FEATURED FINISHES:** Flat Black (19), Satin Stainless (32D)

**FINISHES:** Standard & Custom Available (See Pages 16 & 17)

**MATERIALS:** Aluminum, Brass, Bronze, Stainless Steel

**PRODUCT OPTIONS:** Cutouts Available (Complete PDF Form to Specify),

**FIRE RATED 18GA AVAILABLE:** Use suffix code F (K42F)

**MOUNTING OPTIONS:** SMS (**Standard**), MS, TEK (SDS), Torx, Tape, No Holes/No Tape

**NOTES:** Complete PDF Form to Specify Cutouts • Custom sizes available • Comes Standard with Countersunk Holes for Screw MTG & Protective Plastic Film



# GUARDS & ASTRAGALS

## EDGE GUARDS

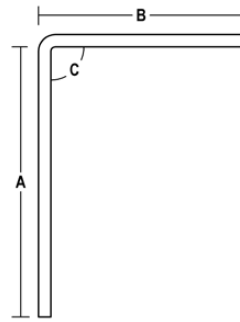

### K43

#### 90° SURFACE EDGE GUARD - HALF

NO.	A	B	C
K43	1.75" (ID)	1.25"	90°

**FEATURED FINISHES:** Flat Black (19), Satin Stainless (32D)

**FINISHES:** Standard & Custom Available (See Pages 16 & 17)

**MATERIALS:** Aluminum, Brass, Bronze, Stainless Steel

**PRODUCT OPTIONS:** Cutouts Available (Complete PDF Form to Specify),

**FIRE RATED 18GA AVAILABLE:** Use suffix code F (K43F)

**MOUNTING OPTIONS:** SMS (**Standard**), MS, TEK (SDS), Torx, Tape, No Holes/No Tape

**NOTES:** Complete PDF Form to Specify Cutouts • Custom sizes available • Comes Standard with Countersunk Holes for Screw MTG & Protective Plastic Film

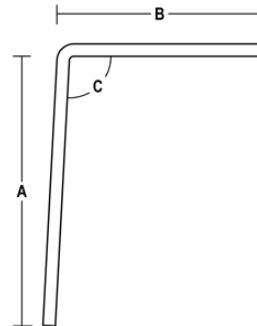

### K44

#### 93° SURFACE EDGE GUARD - HALF

NO.	A	B	C
K44	1.75" (ID)	1.25"	93°

**FEATURED FINISHES:** Flat Black (19), Satin Stainless (32D)

**FINISHES:** Standard & Custom Available (See Pages 16 & 17)

**MATERIALS:** Aluminum, Brass, Bronze, Stainless Steel

**PRODUCT OPTIONS:** Cutouts Available (Complete PDF Form to Specify),

**FIRE RATED 18GA AVAILABLE:** Use suffix code F (K44F)

**MOUNTING OPTIONS:** SMS (**Standard**), MS, TEK (SDS), Torx, Tape, No Holes/No Tape

**NOTES:** Complete PDF Form to Specify Cutouts • Custom sizes available • Comes Standard with Countersunk Holes for Screw MTG & Protective Plastic Film



# GUARDS & ASTRAGALS

## CORNER GUARDS

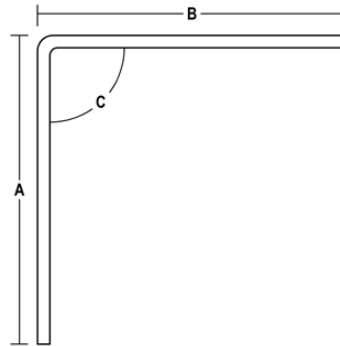

### K28 1.25" CORNER GUARD

NO.	A	B	C
K28	1.25"	1.25"	90°

**FEATURED FINISHES:** Flat Black (19), Satin Stainless (32D)

**FINISHES:** Standard & Custom Available (See Pages 16 & 17)

**MATERIALS:** Aluminum, Brass, Bronze, Stainless Steel, Kydex, Acrylic

**MOUNTING OPTIONS:** SMS (Standard), MS, TEK (SDS), Torx, Tape, No Holes/No Tape

**NOTES:** Standard Length is 40" • Custom sizes available • Comes Standard with Countersunk Holes for Screw MTG & Protective Plastic Film

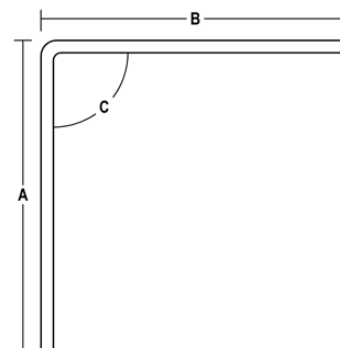

### K29 3" CORNER GUARD

NO.	A	B	C
K29	3"	3"	90°

**FEATURED FINISHES:** Flat Black (19), Satin Stainless (32D)

**FINISHES:** Standard & Custom Available (See Pages 16 & 17)

**MATERIALS:** Aluminum, Brass, Bronze, Stainless Steel, Kydex, Acrylic

**MOUNTING OPTIONS:** SMS (Standard), MS, TEK (SDS), Torx, Tape, No Holes/No Tape

**NOTES:** Standard Length is 40" • Custom sizes available • Comes Standard with Countersunk Holes for Screw MTG & Protective Plastic Film





# GUARDS & ASTRAGALS

## ASTRAGALS

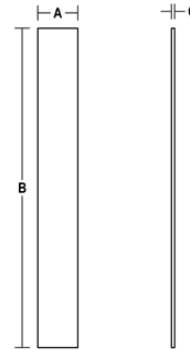

### K35

#### 1.5" ASTRAGAL

NO.	A	B	C
K35	1.5"	SPECIFY	0.125"

**FEATURED FINISHES:** Flat Black (19), Satin Stainless (32D)

**FINISHES:** Standard & Custom Available (See Pages 16 & 17)

**MATERIAL:** Stainless Steel

**MOUNTING OPTIONS:** SMS (Standard), MS, TEK (SDS), Torx, Tape, No Holes/No Tape

**NOTES:** Specify Door Height • Custom sizes available • Comes Standard with Countersunk Holes for Screw MTG & Protective Plastic Film

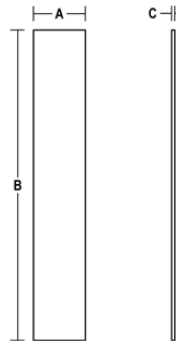

### K36

#### 2" ASTRAGAL

NO.	A	B	C
K36	2"	SPECIFY	0.125"

**FEATURED FINISHES:** Flat Black (19), Satin Stainless (32D)

**FINISHES:** Standard & Custom Available (See Pages 16 & 17)

**MATERIAL:** Stainless Steel

**MOUNTING OPTIONS:** SMS (Standard), MS, TEK (SDS), Torx, Tape, No Holes/No Tape

**NOTES:** Specify Door Height • Custom sizes available • Comes Standard with Countersunk Holes for Screw MTG & Protective Plastic Film



# GUARDS & ASTRAGALS

## ASTRAGALS

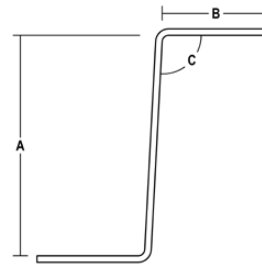

### K61

#### 93° BEVELED EDGE Z ASTRAGAL - ACTIVE LEAF

NO.	DOOR HEIGHT	A	B	C
K61	SPECIFY	1.75 (ID)	0.875"	93°

**FEATURED FINISHES:** Flat Black (19), Satin Stainless (32D)

**FINISHES:** Standard & Custom Available (See Pages 16 & 17)

**MATERIAL:** Aluminum, Brass, Bronze, Stainless Steel

**MOUNTING OPTIONS:** SMS (**Standard**), MS, TEK (SDS), Torx, Tape, No Holes/No Tape

**PRODUCT OPTIONS:** Cutouts Available (Specify Size and Location)

**NOTES:** Specify Door Height • Specify Door Thickness • Custom sizes available •

Comes Standard with Countersunk Holes for Screw MTG & Protective Plastic Film

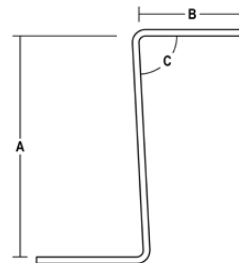

### K62

#### 87° BEVELED EDGE Z ASTRAGAL - INACTIVE LEAF

NO.	DOOR HEIGHT	A	B	C
K62	SPECIFY	1.75 (ID)	0.875"	87°

**FEATURED FINISHES:** Flat Black (19), Satin Stainless (32D)

**FINISHES:** Standard & Custom Available (See Pages 16 & 17)

**MATERIAL:** Aluminum, Brass, Bronze, Stainless Steel

**PRODUCT OPTIONS:** Cutouts Available (Specify Size and Location)

**MOUNTING OPTIONS:** SMS (**Standard**), MS, TEK (SDS), Torx, Tape, No Holes/No Tape

**NOTES:** Specify Door Height • Specify Door Thickness • Custom sizes available •

Comes Standard with Countersunk Holes for Screw MTG & Protective Plastic Film



# GUARDS & ASTRAGALS

## ASTRAGALS

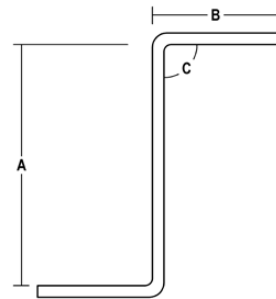

### K60 SQUARE EDGE Z ASTRAGAL

NO.	DOOR HEIGHT	A	B	C
K60	SPECIFY	1.75 (ID)	0.875"	90°

**FEATURED FINISHES:** Flat Black (19), Satin Stainless (32D)

**FINISHES:** Standard & Custom Available (See Pages 16 & 17)

**MATERIALS:** Aluminum, Brass, Bronze, Stainless Steel

**MOUNTING OPTIONS:** SMS (**Standard**), MS, TEK (SDS), Torx, Tape, No Holes/No Tape

**PRODUCT OPTIONS:** Cutouts Available (Specify Size and Location)

**NOTES:** Specify Door Height • Specify Door Thickness • Custom sizes available •

Comes Standard with Countersunk Holes for Screw MTG & Protective Plastic Film



# GUARDS & ASTRAGALS

## FRAME GUARDS

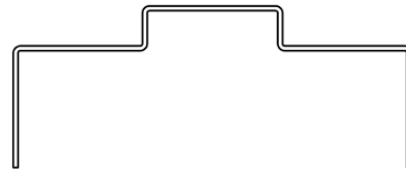

### K50 FRAME GUARD - FULL

NO.	
K50	SPECIFY USING ORDER FORM

- FEATURED FINISHES:** Flat Black (19), Satin Stainless (32D)
- FINISHES:** Standard & Custom Available (See Pages 16 & 17)
- MATERIAL:** Aluminum, Brass, Bronze, Stainless Steel
- PRODUCT OPTIONS:** Cutouts Available (Specify Size and Location)
- FIRE RATED 18GA AVAILABLE:** Use suffix code F (K50F)
- MOUNTING OPTIONS:** SMS (**Standard**), MS, TEK (SDS), Torx, Tape, No Holes/No Tape
- NOTES:** Complete PDF Form to Specify Sizes • Custom sizes available • Comes Standard with Countersunk Holes for Screw MTG & Protective Plastic Film



# GUARDS & ASTRAGALS

## FRAME GUARDS

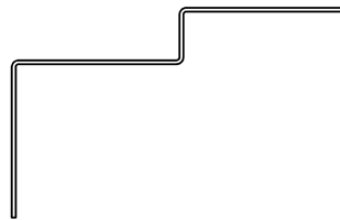

### **K51** FRAME GUARD - HALF

<b>NO.</b>	
<b>K51</b>	SPECIFY USING ORDER FORM

**MATERIAL:** Aluminum, Brass, Bronze, Stainless Steel

**FEATURED FINISHES:** Flat Black (19), Satin Stainless (32D)

**PRODUCT OPTIONS:** Cutouts Available (Specify Size and Location)

**FIRE RATED 18GA AVAILABLE:** Use suffix code F (K51F)

**MOUNTING OPTIONS:** SMS (**Standard**), MS, TEK (SDS), Torx, Tape, No Holes/No Tape

**NOTES:** Complete PDF Form to Specify Sizes • Custom sizes available • Comes Standard with Countersunk Holes for Screw MTG & Protective Plastic Film



# GUARDS & ASTRAGALS

## TRIM GUARDS

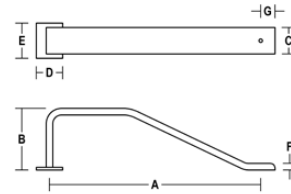
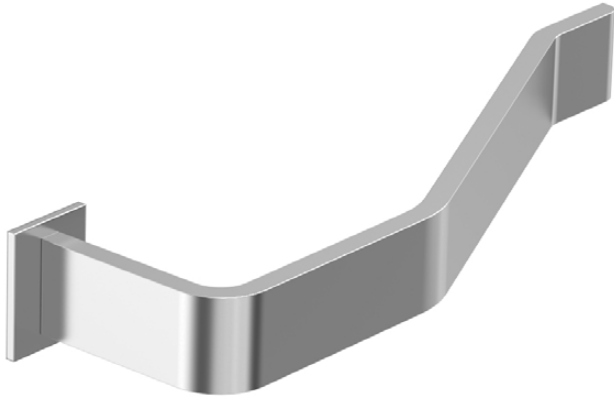

### B318

#### 12" HEAVY DUTY TRIM GUARD

NO.	A	B	C	D	E	F	G
<b>B318</b>	12"	3.25"	1.5"	1.5"	2.25"	0.375"	0.75"

**FEATURED FINISHES:** Flat Black (19), Satin Stainless (32D)

**FINISHES:** Standard & Custom Available (See Pages 16 & 17)

**MATERIALS:** Aluminum, Stainless Steel

**MOUNTING OPTIONS:** 1/4-20 Thru Bolts & Finishing Washer

**NOTES:** Custom Sizes Available

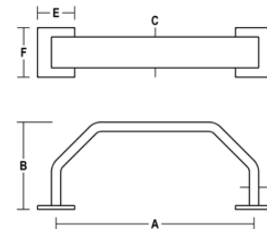
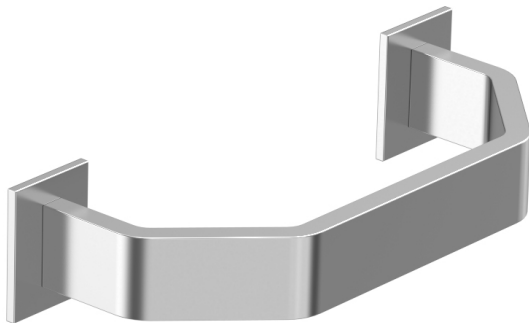

### B319

#### HEAVY DUTY TRIM GUARD - 3.25" PROJ

NO.	A	B	C	D	E	F
<b>B319</b>	8"	3.25"	1.5"	0.375"	1.5"	2.25"

**FEATURED FINISHES:** Flat Black (19), Satin Stainless (32D)

**FINISHES:** Standard & Custom Available (See Pages 16 & 17)

**MATERIALS:** Aluminum, Stainless Steel

**MOUNTING OPTIONS:** 1/4-20 Thru Bolts & Finishing Washer

**NOTES:** Custom Sizes Available

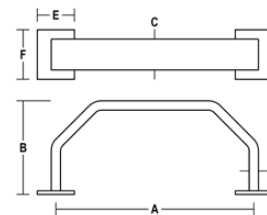
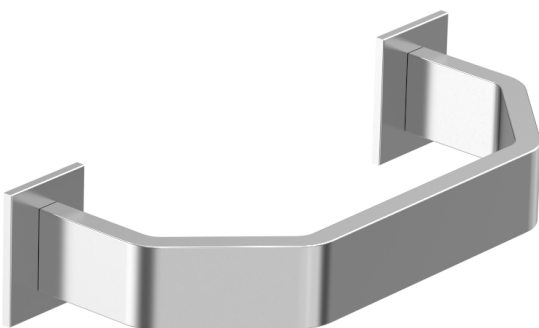

### B320

#### HEAVY DUTY TRIM GUARD - 3.75" PROJ

NO.	A	B	C	D	E	F
<b>B320</b>	8"	3.75"	1.5"	0.375"	1.5"	2.25"

**FEATURED FINISHES:** Flat Black (19), Satin Stainless (32D)

**FINISHES:** Standard & Custom Available (See Pages 16 & 17)

**MATERIALS:** Aluminum, Stainless Steel

**MOUNTING OPTIONS:** 1/4-20 Thru Bolts & Finishing Washer

**NOTES:** Custom Sizes Available



# GUARDS & ASTRAGALS

## TRIM GUARDS

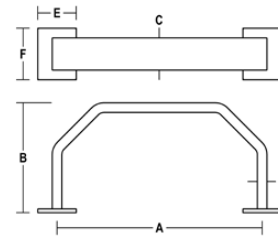
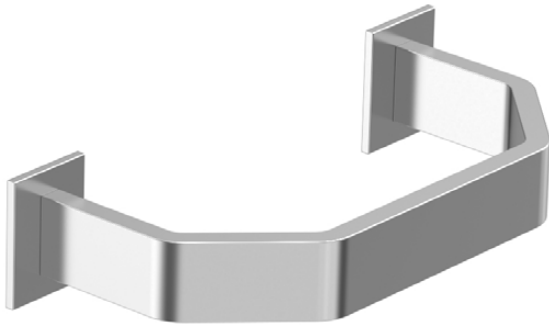

### B321

#### HEAVY DUTY TRIM GUARD - 4.25" PROJ

NO.	A	B	C	D	E	F
B321	8"	4.25"	1.5"	0.375"	1.5"	2.25"

**FEATURED FINISHES:** Flat Black (19), Satin Stainless (32D)

**FINISHES:** Standard & Custom Available (See Pages 16 & 17)

**MATERIALS:** Aluminum, Stainless Steel

**MOUNTING OPTIONS:** 1/4-20 Thru Bolts & Finishing Washer

**NOTES:** Custom Sizes Available

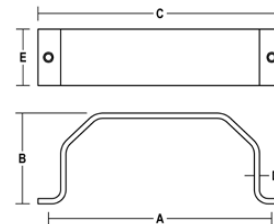
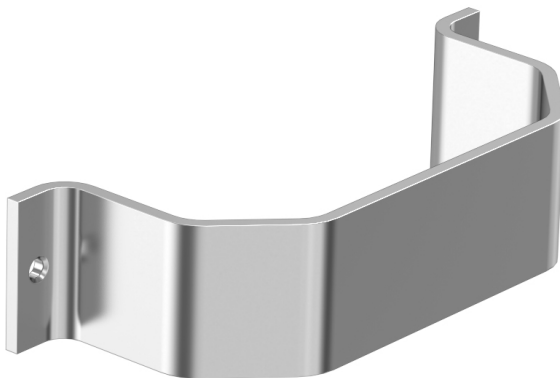

### B322

#### STANDARD DUTY TRIM GUARD - 3.25" PROJ

NO.	A	B	C	D	E
B322	8"	3.25"	8.75"	0.1875"	2"

**FEATURED FINISHES:** Flat Black (19), Satin Stainless (32D)

**FINISHES:** Standard & Custom Available (See Pages 16 & 17)

**MATERIALS:** Aluminum, Stainless Steel

**MOUNTING OPTIONS:** #10-24 Flat Head Machine Screw & Sex Bolt

**NOTES:** Custom Sizes Available



# GUARDS & ASTRAGALS

## TRIM GUARDS

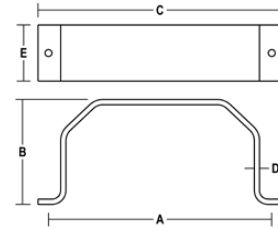
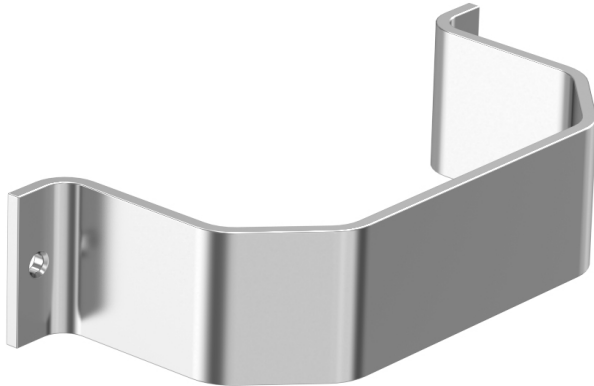

**B323**  
**STANDARD DUTY TRIM GUARD**  
**- 3.75" PROJ**

NO.	A	B	C	D	E
<b>B323</b>	8"	3.75"	8.75"	0.1875"	2"

**FEATURED FINISHES:** Flat Black (19), Satin Stainless (32D)

**FINISHES:** Standard & Custom Available (See Pages 16 & 17)

**MATERIALS:** Aluminum, Stainless Steel

**MOUNTING OPTIONS:** #10-24 Flat Head Machine Screw & Sex Bolt

**NOTES:** Custom Sizes Available

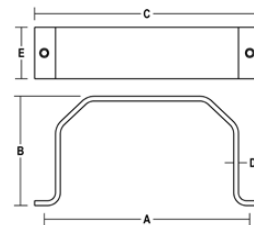
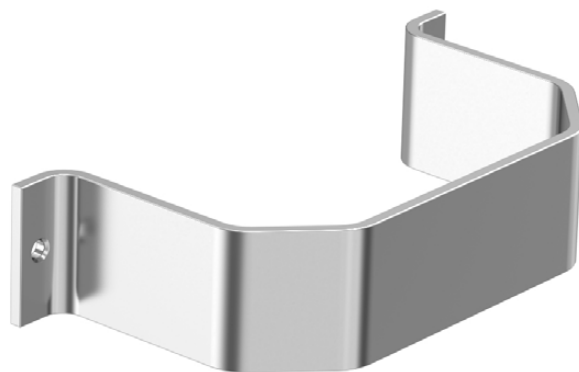

**B324**  
**TANDARD DUTY TRIM GUARD**  
**- 4.25" PROJ**

NO.	A	B	C	D	E
<b>B324</b>	8"	4.25"	8.75"	0.1875"	2"

**FEATURED FINISHES:** Flat Black (19), Satin Stainless (32D)

**FINISHES:** Standard & Custom Available (See Pages 16 & 17)

**MATERIALS:** Aluminum, Stainless Steel

**MOUNTING OPTIONS:** #10-24 Flat Head Machine Screw & Sex Bolt

**NOTES:** Custom Sizes Available





# GUARDS & ASTRAGALS

## TRIM GUARDS

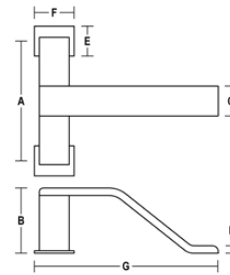
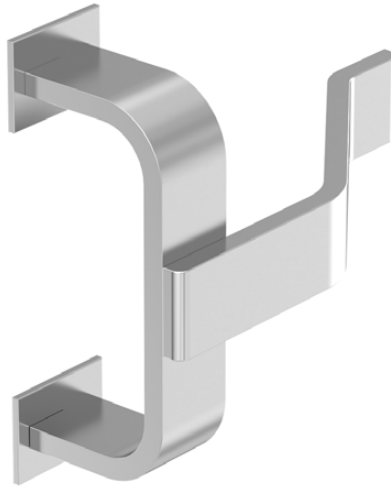

### **B325**

#### HEAVY DUTY EXIT DEVICE GUARD - 3.25" PROJ

NO.	A	B	C	D	E	F	G
<b>B325</b>	6"	3.25"	1.5"	0.375"	1.5"	2"	9.25"

**FEATURED FINISHES:** Flat Black (19), Satin Stainless (32D)

**FINISHES:** Standard & Custom Available (See Pages 16 & 17)

**MATERIALS:** Aluminum, Stainless Steel

**MOUNTING OPTIONS:** 1/4-20 Thru Bolts & Finishing Washer

**NOTES:** Custom Sizes Available

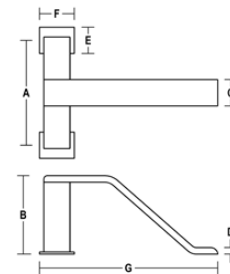
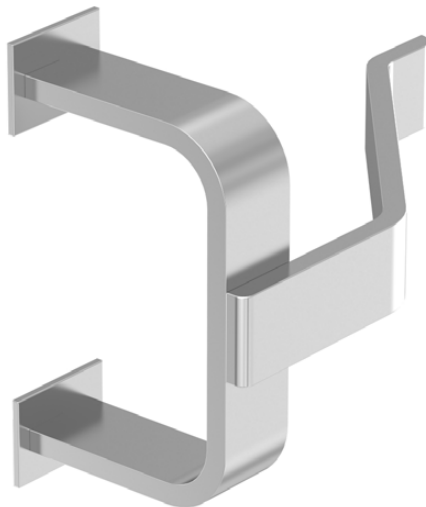

### **B326**

#### HEAVY DUTY EXIT DEVICE GUARD - 4.5" PROJ

NO.	A	B	C	D	E	F	G
<b>B326</b>	6"	4.5"	1.5"	0.375"	1.5"	2"	10.25"

**FEATURED FINISHES:** Flat Black (19), Satin Stainless (32D)

**FINISHES:** Standard & Custom Available (See Pages 16 & 17)

**MATERIALS:** Aluminum, Stainless Steel

**MOUNTING OPTIONS:** 1/4-20 Thru Bolts & Finishing Washer

**NOTES:** Custom Sizes Available



# GRAB BARS

---



**180** Ø 1-1/4" - STRAIGHT GRAB BARS

**181** Ø 1-1/4" - ANGLED GRAB BARS

**185** Ø 1-1/4" - LIFT UP GRAB BARS

**186** Ø 1-1/2" - STRAIGHT GRAB BARS

**187** Ø 1-1/2" - ANGLED GRAB BARS





# GRAB BARS

## Ø 1-1/4" - STRAIGHT GRAB BARS

### STRAIGHT GRAB BAR - Ø 1-1/4"

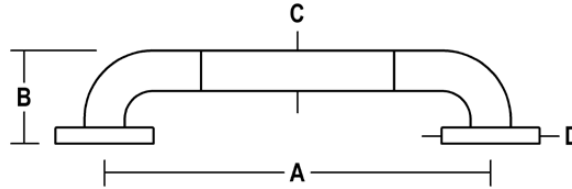

NO.	A	B	C	D
<b>G200-70-P</b>	12" CTC	2.875"	Ø 1.25"	Ø 3"
<b>G201-70-P</b>	16" CTC	2.875"	Ø 1.25"	Ø 3"
<b>G202-70-P</b>	18" CTC	2.875"	Ø 1.25"	Ø 3"
<b>G203-70-P</b>	24" CTC	2.875"	Ø 1.25"	Ø 3"
<b>G204-70-P</b>	30" CTC	2.875"	Ø 1.25"	Ø 3"
<b>G205-70-P</b>	32" CTC	2.875"	Ø 1.25"	Ø 3"
<b>G206-70-P</b>	36" CTC	2.875"	Ø 1.25"	Ø 3"
<b>G260-70-P</b>	42" CTC	2.875"	Ø 1.25"	Ø 3"
<b>G207-70-P</b>	48" CTC	2.875"	Ø 1.25"	Ø 3"

**FEATURED FINISHES:** Flat Black TexGrip (19TEX), Satin Stainless (32D)

**FINISHES:** Standard & Custom Available (See Pages 16 & 17)

**MATERIAL:** Stainless Steel

**NOTES:** Ø 1.25" Stainless Steel Tubing

### STRAIGHT GRAB BAR W/ MID POST - Ø 1-1/4"

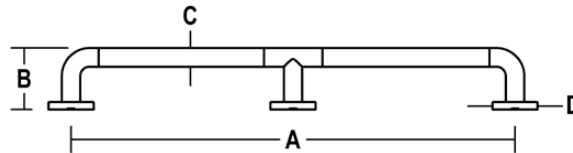

NO.	A	B	C	D
<b>G214-70-P</b>	24" CTC	2.875"	Ø 1.25"	Ø 3"
<b>G215-70-P</b>	30" CTC	2.875"	Ø 1.25"	Ø 3"
<b>G216-70-P</b>	36" CTC	2.875"	Ø 1.25"	Ø 3"
<b>G217-70-P</b>	48" CTC	2.875"	Ø 1.25"	Ø 3"

**FEATURED FINISHES:** Flat Black TexGrip (19TEX), Satin Stainless (32D)

**FINISHES:** Standard & Custom Available (See Pages 16 & 17)

**MATERIAL:** Stainless Steel

**NOTES:** Ø 1.25" Stainless Steel Tubing



# GRAB BARS

## Ø 1-1/4" - ANGLED GRAB BARS

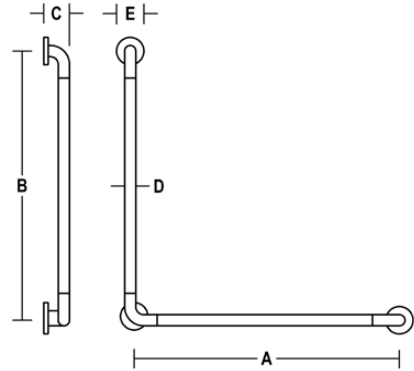
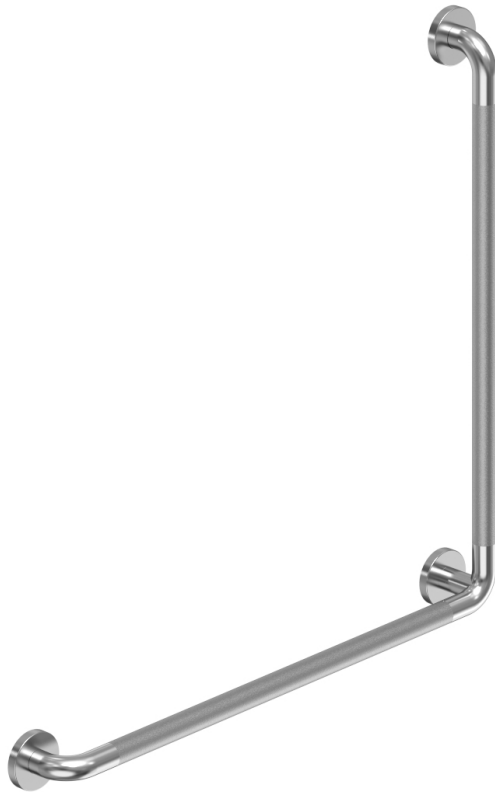

### G218-70-P

#### 30" X 30" X 90° GRAB BAR - Ø 1-1/4"

NO.	A	B	C	D	E
G218-70-P	30"	30"	2.875"	Ø 1.25"	Ø 3"

**FEATURED FINISHES:** Flat Black TexGrip (19TEX),  
Satin Stainless (32D),

**FINISHES:** Standard & Custom Available (See Pages 16 & 17)

**MATERIAL:** Stainless Steel

**NOTES:** Ø 1.25" Stainless Steel Tubing

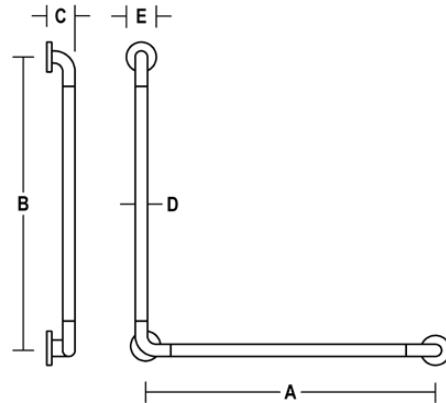

### G219-70-P

#### 36" X 36" X 90° GRAB BAR - Ø 1-1/4"

NO.	A	B	C	D	E
G219-70-P	36"	36"	2.875"	Ø 1.25"	Ø 3"

**FEATURED FINISHES:** Flat Black TexGrip (19TEX),  
Satin Stainless (32D)

**FINISHES:** Standard & Custom Available (See Pages 16 & 17)

**MATERIAL:** Stainless Steel

**NOTES:** Ø 1.25" Stainless Steel Tubing



# GRAB BARS

## Ø 1-1/4" - ANGLED GRAB BARS

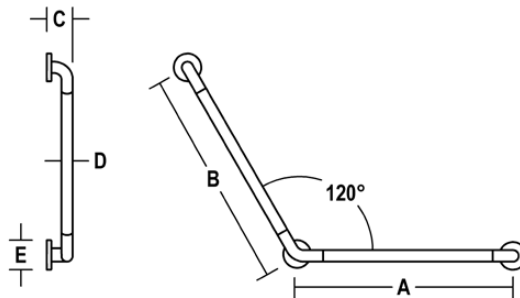

### G220-70-P

#### 24" X 24" X 120° GRAB BAR - Ø 1-1/4"

NO.	A	B	C	D	E
G220-70-P	24"	24"	2.875"	Ø 1.25"	Ø 3"

**FEATURED FINISHES:** Flat Black TexGrip (19TEX),  
Satin Stainless (32D)

**FINISHES:** Standard & Custom Available (See Pages 16 & 17)

**MATERIAL:** Stainless Steel

**NOTES:** Ø 1.25" Stainless Steel Tubing



# GRAB BARS

## Ø 1-1/4" - ANGLED GRAB BARS

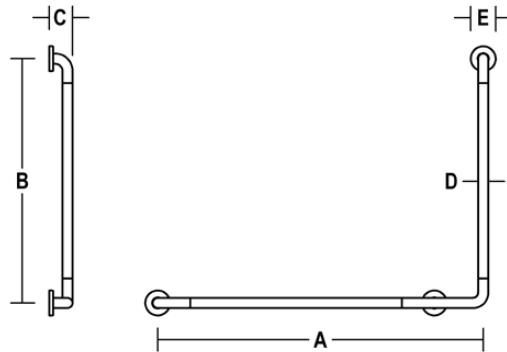

### **G240-70-P**

#### **40" X 30" X 90° X GRAB BAR - Ø 1-1/4"**

<b>NO.</b>	<b>A</b>	<b>B</b>	<b>C</b>	<b>D</b>	<b>E</b>
<b>G240-70-P</b>	40"	30"	2.875"	Ø 1.25"	Ø 3"

**FEATURED FINISHES:** Flat Black TexGrip (19TEX),  
Satin Stainless (32D)

**FINISHES:** Standard & Custom Available (See Pages 16 & 17)

**MATERIAL:** Stainless Steel

**NOTES:** Ø 1.25" Stainless Steel Tubing



# GRAB BARS

## Ø 1-1/4" - ANGLED GRAB BARS

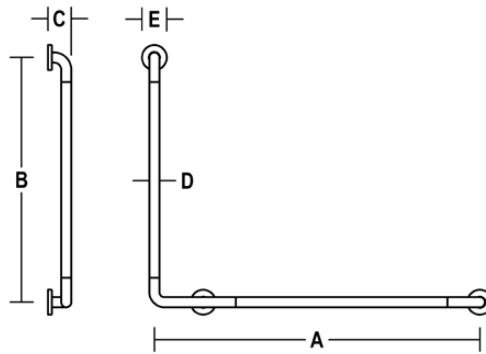

### **G241-70-P**

#### **40" X 30" X 90° X GRAB BAR - Ø 1-1/4"**

NO.	A	B	C	D	E
G241-70-P	40"	30"	2.875"	Ø 1.25"	Ø 3"

**FEATURED FINISHES:** Flat Black TexGrip (19TEX),  
Satin Stainless (32D)

**FINISHES:** Standard & Custom Available (See Pages 16 & 17)

**MATERIAL:** Stainless Steel

**NOTES:** Ø 1.25" Stainless Steel Tubing





# GRAB BARS

## Ø 1-1/4" - LIFT UP GRAB BARS

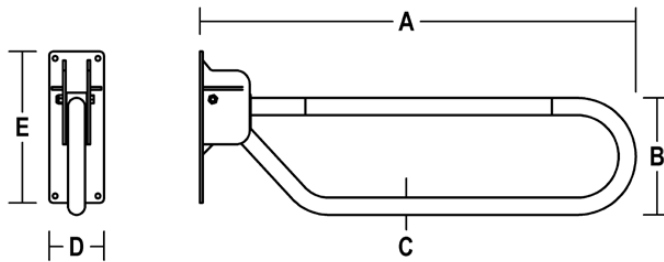

Carrier Bar Available

### G227-P

#### 32" LIFT UP GRAB BAR - Ø 1-1/4"

NO.	A	B	C	D	E
G227-P	32"	8.5"	Ø 1.25"	4"	11"

**FEATURED FINISHES:** Flat Black TexGrip (19TEX), Satin Stainless (32D)

**FINISHES:** Standard & Custom Available (See Pages 16 & 17)

**MATERIAL:** Stainless Steel

**NOTES:** Aluminum Cast Powdercoat White • Ø 1.25" Stainless Steel Tubing

**PRODUCT OPTIONS:** Optional Toilet Paper Holder (G227-P-T) • Carrier Bar Available



# GRAB BARS

## Ø 1-1/2" - STRAIGHT GRAB BARS

### STRAIGHT GRAB BAR - Ø 1-1/2"

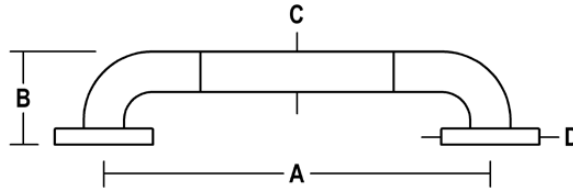

NO.	A	B	C	D
G300-70-P	12" CTC	3"	Ø 1.5"	Ø 3"
G301-70-P	16" CTC	3"	Ø 1.5"	Ø 3"
G302-70-P	18" CTC	3"	Ø 1.5"	Ø 3"
G303-70-P	24" CTC	3"	Ø 1.5"	Ø 3"
G304-70-P	30" CTC	3"	Ø 1.5"	Ø 3"
G305-70-P	32" CTC	3"	Ø 1.5"	Ø 3"
G306-70-P	36" CTC	3"	Ø 1.5"	Ø 3"
G307-70-P	48" CTC	3"	Ø 1.5"	Ø 3"

**FEATURED FINISHES:** Flat Black TexGrip (19TEX), Satin Stainless (32D)

**FINISHES:** Standard & Custom Available (See Pages 16 & 17)

**MATERIAL:** Stainless Steel

**NOTES:** Ø 1.5" Stainless Steel Tubing

### STRAIGHT GRAB BAR W/ MID POST - Ø 1-1/2"

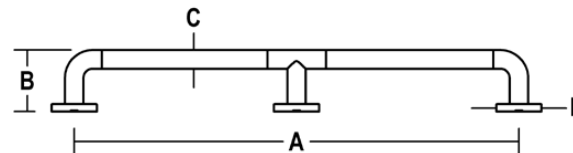
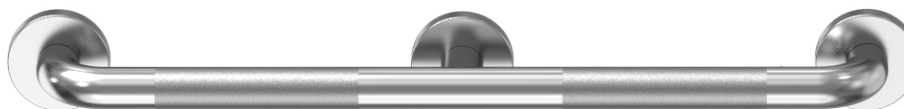

NO.	A	B	C	D
G314-70-P	24" CTC	3"	Ø 1.5"	Ø 3"
G315-70-P	30" CTC	3"	Ø 1.5"	Ø 3"
G316-70-P	36" CTC	3"	Ø 1.5"	Ø 3"
G317-70-P	48" CTC	3"	Ø 1.5"	Ø 3"

**FEATURED FINISHES:** Flat Black TexGrip (19TEX), Satin Stainless (32D)

**FINISHES:** Standard & Custom Available (See Pages 16 & 17)

**MATERIAL:** Stainless Steel

**NOTES:** Ø 1.5" Stainless Steel Tubing



# GRAB BARS

## Ø 1-1/2" - ANGLED GRAB BARS

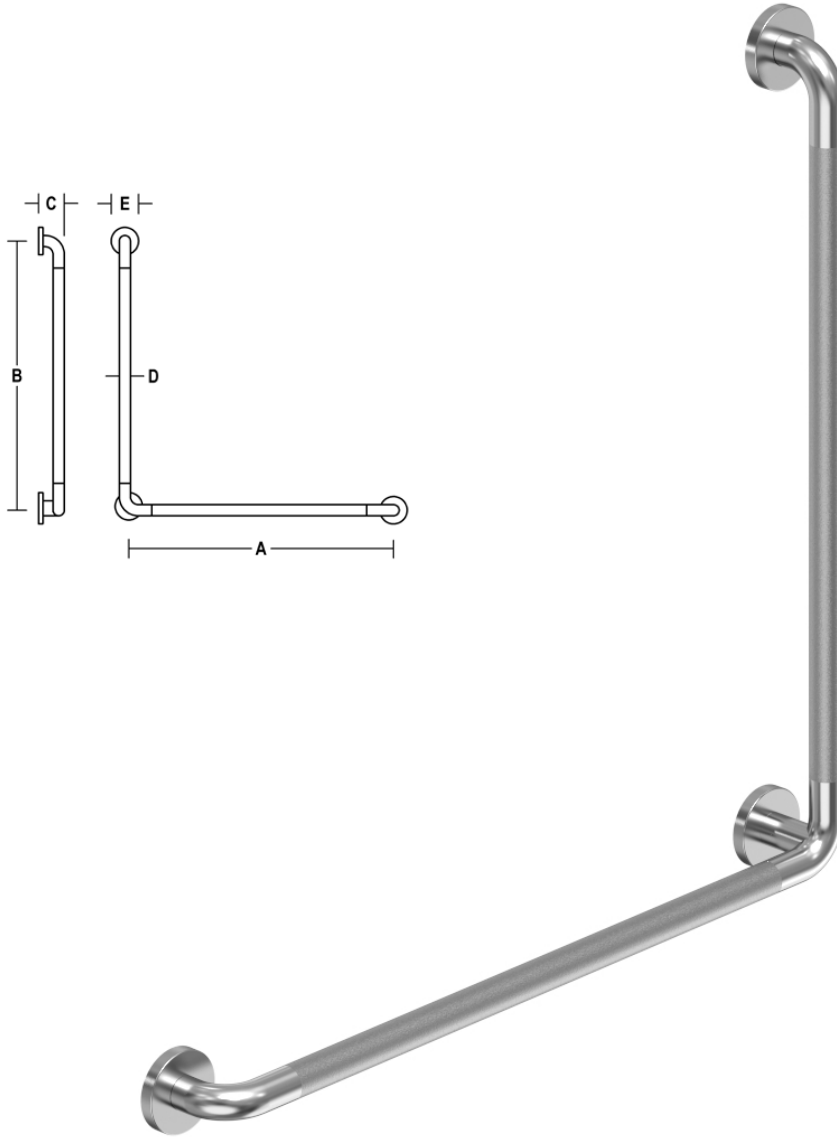

**G318-70-P**  
**30" X 30" X 90° GRAB BAR - Ø 1-1/2"**

NO.	A	B	C	D	E
G318-70-P	30"	30"	3"	Ø 1.5"	Ø 3"

**FEATURED FINISHES:** Flat Black TexGrip (19TEX),  
 Satin Stainless (32D)

**FINISHES:** Standard & Custom Available (See Pages 16 & 17)

**MATERIAL:** Stainless Steel

**NOTES:** Ø 1.5" Stainless Steel Tubing



# GRAB BARS

## Ø 1-1/2" - ANGLED GRAB BARS

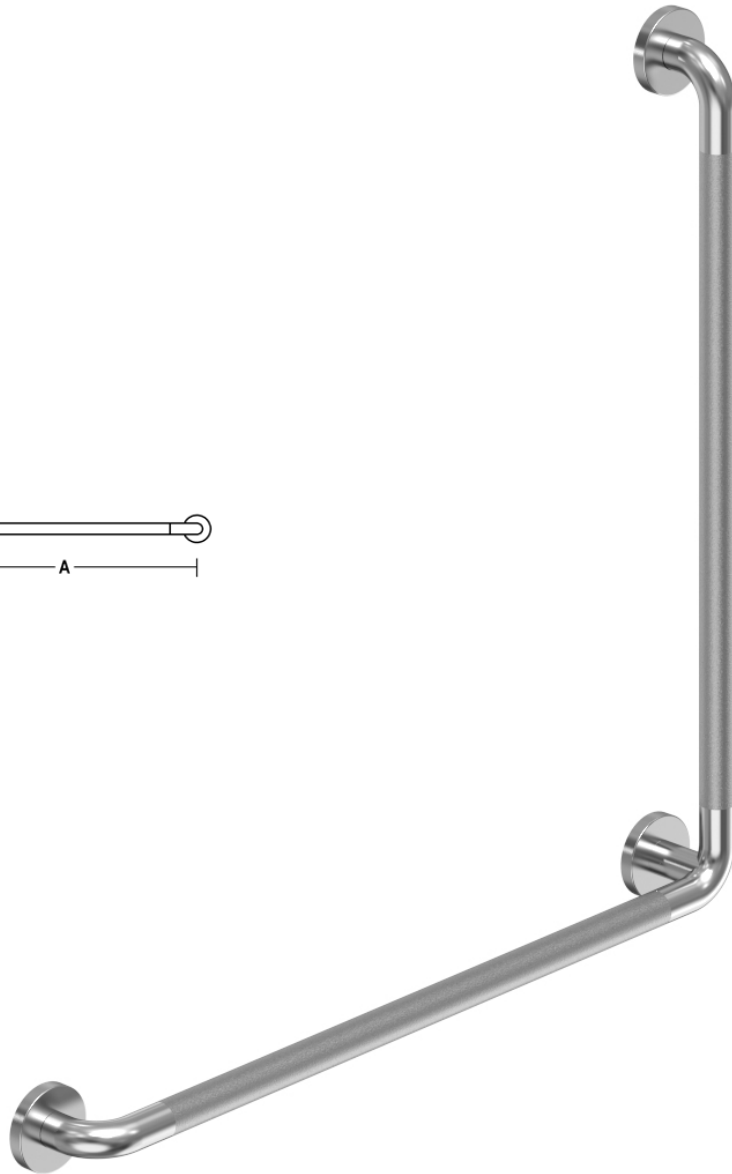
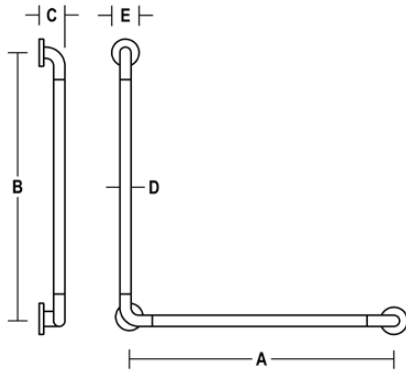

### G319-70-P

#### 36" X 36" X 90° GRAB BAR - Ø 1-1/2"

NO.	A	B	C	D	E
G319-70-P	36"	36"	3"	Ø 1.5"	Ø 3"

**FEATURED FINISHES:** Flat Black TexGrip (19TEX),  
Satin Stainless (32D)

**FINISHES:** Standard & Custom Available (See Pages 16 & 17)

**MATERIAL:** Stainless Steel

**NOTES:** Ø 1.5" Stainless Steel Tubing



# GRAB BARS

## Ø 1-1/2" - ANGLED GRAB BARS

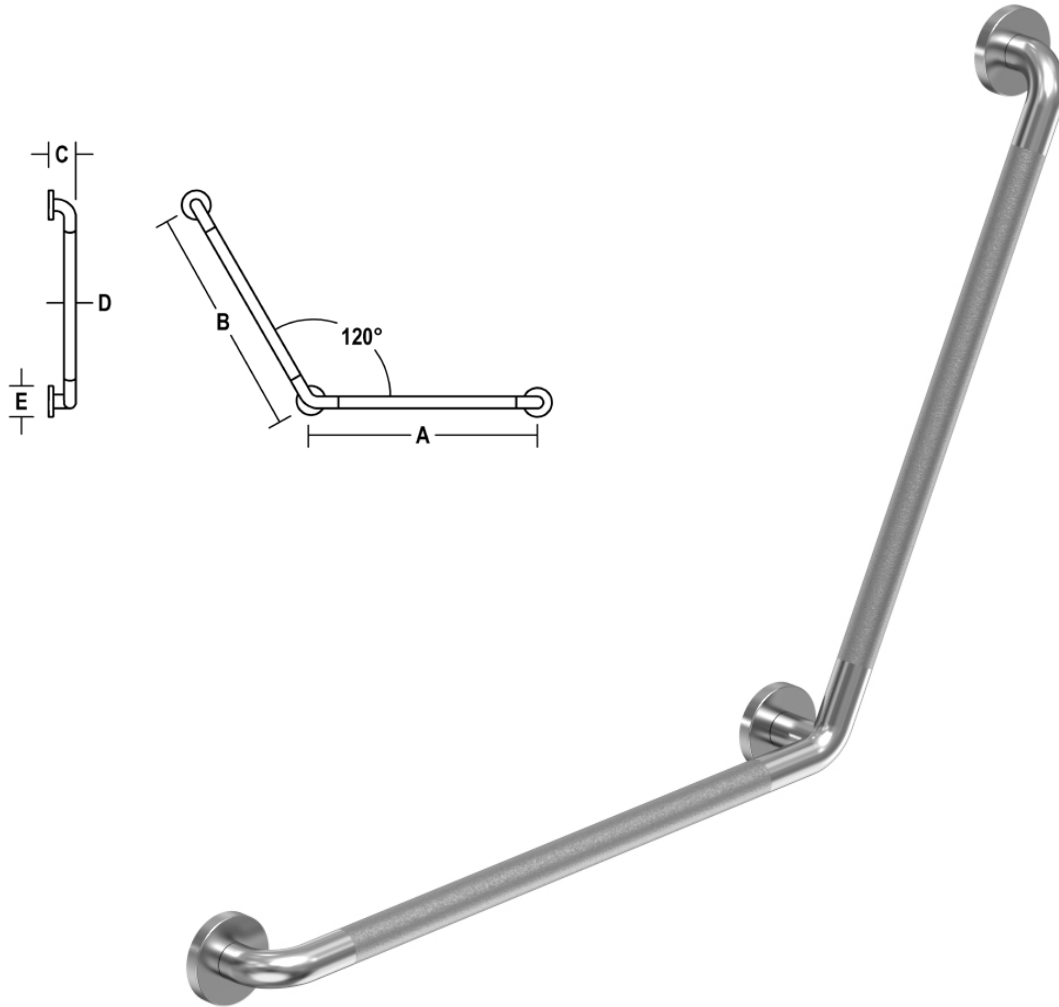

### **G320-70-P**

#### **24" X 24" X 120° GRAB BAR - Ø 1-1/2"**

<b>NO.</b>	<b>A</b>	<b>B</b>	<b>C</b>	<b>D</b>	<b>E</b>
<b>G320-70-P</b>	24"	24"	3"	Ø 1.5"	Ø 3"

**FEATURED FINISHES:** Flat Black TexGrip (19TEX),

Satin Stainless (32D)

**FINISHES:** Standard & Custom Available (See Pages 16 & 17)

**MATERIAL:** Stainless Steel

**NOTES:** Ø 1.5" Stainless Steel Tubing



# DOOR STOPS

---

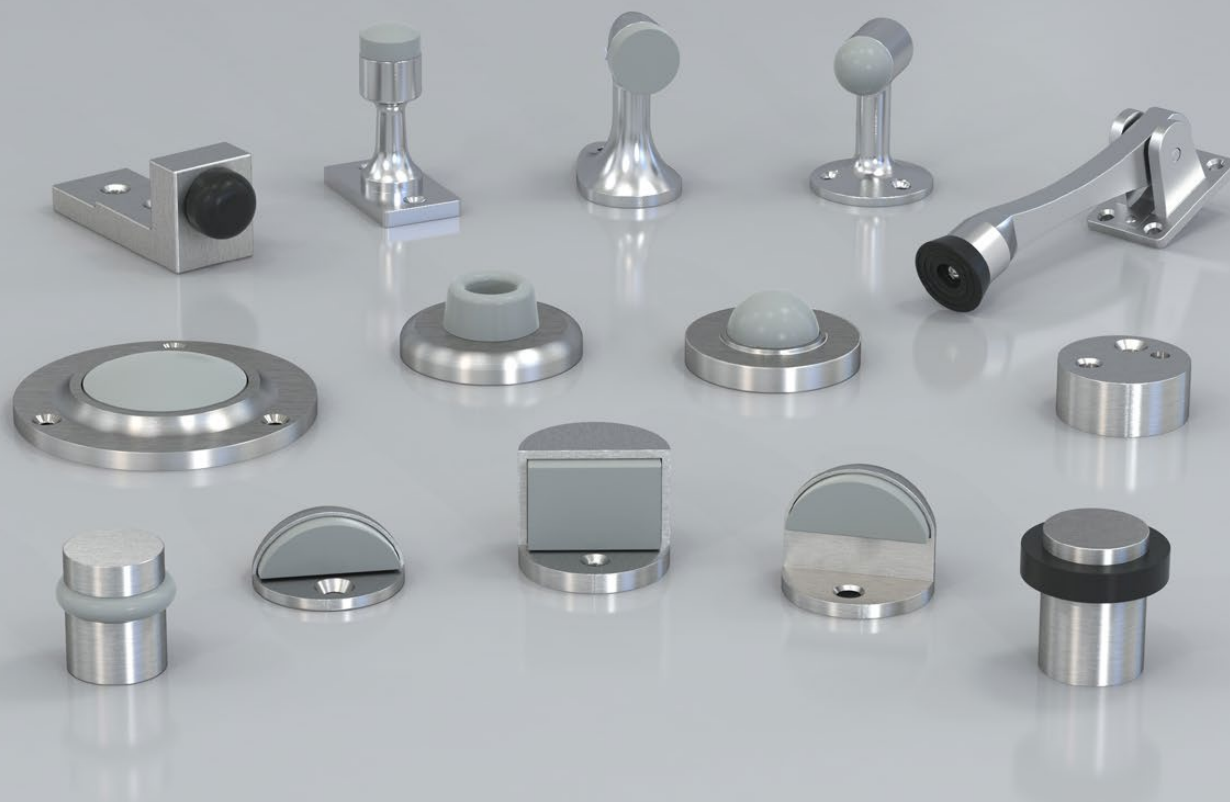

**192** FLOOR STOPS

**199** WALL STOPS

**202** BASEBOARD STOPS

**203** DOOR HOLDERS





# DOOR STOPS

## FLOOR STOPS



### S100

#### DOME FLOOR STOP

NO.	A	B	C
S100	1"	0.1875"	Ø 1.75"

**FEATURED FINISHES:** Flat Black (19), Satin Chrome (26D)

**FINISHES:** 3, 4, 10B, 15, 19, 26, 26D

**MATERIAL:** Zinc Die Cast

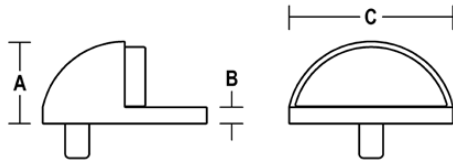

### S101

#### HEAVY DUTY DOME FLOOR STOP

NO.	A	B	C
S101	1.125"	0.1875"	Ø 1.875"

**FEATURED FINISHES:** Flat Black (19), Satin Chrome (26D)

**FINISHES:** 10BE, 19, 26D, PC

**MATERIALS:** Cast Brass, Bronze

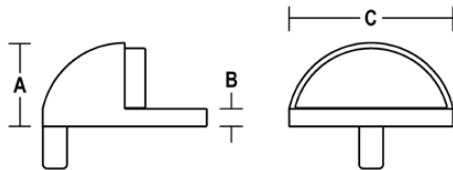

### S102

#### HIGH RISE DOME FLOOR STOP

NO.	A	B	C
S102	1.3125"	0.5"	Ø 1.75"

**FEATURED FINISHES:** Flat Black (19), Satin Chrome (26D)

**FINISHES:** 3, 4, 10B, 15, 19, 26, 26D

**MATERIALS:** Zinc Die Cast

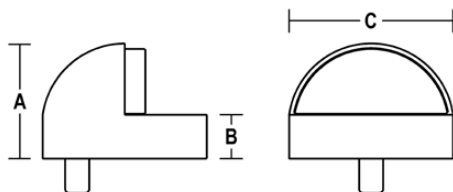





# DOOR STOPS

## FLOOR STOPS



### S102L

#### HIGH RISE LOW PROFILE DOME FLOOR STOP

NO.	A	B	C
S102L	1.5625"	0.1875"	Ø 1.75"

**FEATURED FINISHES:** Flat Black (19), Satin Chrome (26D)

**FINISHES:** 4, 10B, 15, 19, 26, 26D

**MATERIAL:** Zinc Die Cast

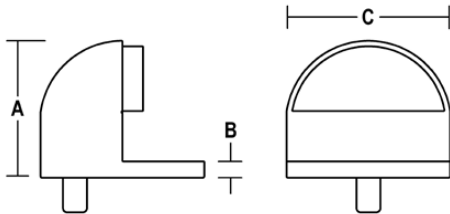

### S102LF

#### HIGH RISE LOW PROFILE SPRING LOADED FLOOR STOP

NO.	A	B	C
S102LF	1.5"	0.25"	Ø 1.875"

**FEATURED FINISHES:** Flat Black (19), Satin Chrome (26D)

**FINISHES:** 10B, 19, 26D

**MATERIALS:** Zinc Die Cast

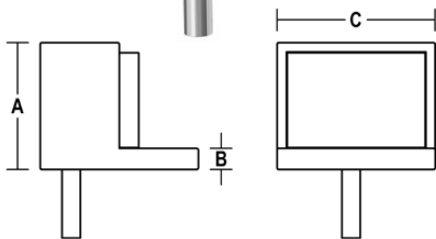

### S103

#### HIGH RISE HEAVY DUTY DOME FLOOR STOP

NO.	A	B	C
S103	1.3125"	0.5"	Ø 1.875"

**FEATURED FINISHES:** Flat Black (19), Satin Chrome (26D)

**FINISHES:** 10BE, 19, 26D, PC

**MATERIALS:** Cast Brass, Bronze

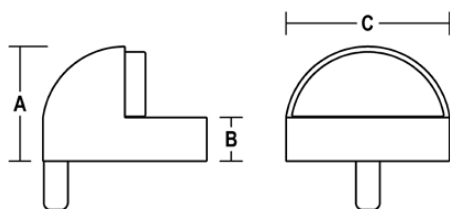



# DOOR STOPS

## FLOOR STOPS

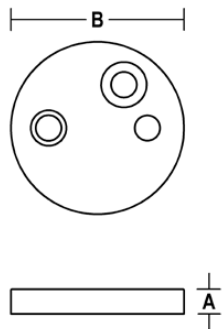
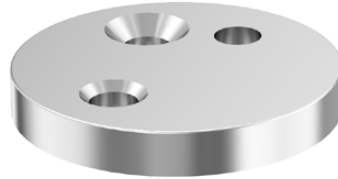

### S104

#### 1/4" DOME FLOOR STOP RISER

NO.	A	B
S104	0.25"	Ø 1.75"

**FEATURED FINISHES:** Flat Black (19), Satin Chrome (26D)

**FINISHES:** 10BE, 19, 26D, PC

**MATERIAL:** Zinc Die Cast

**NOTES:** Compatible With: S100, S101, S102, S102L, S103

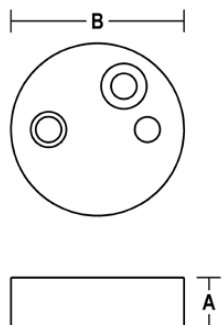
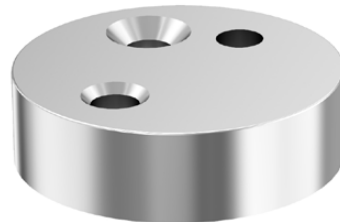

### S105

#### 1/2" DOME FLOOR STOP RISER

NO.	A	B
S105	0.5"	Ø 1.75"

**FEATURED FINISHES:** Flat Black (19), Satin Chrome (26D)

**FINISHES:** 10BE, 19, 26D, PC

**MATERIAL:** Zinc Die Cast

**NOTES:** Compatible With: S100, S101, S102, S102L, S103



# DOOR STOPS

## FLOOR STOPS

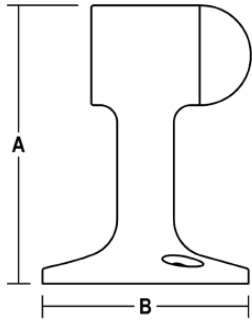

### S107

#### HEAVY DUTY FLOOR STOP

NO.	A	B
S107	2.375"	Ø 1.8125"

**FEATURED FINISHES:** Flat Black (19), Satin Chrome (26D)

**FINISHES:** 10BE, 19, 26D, PC

**MATERIALS:** Cast Brass, Bronze

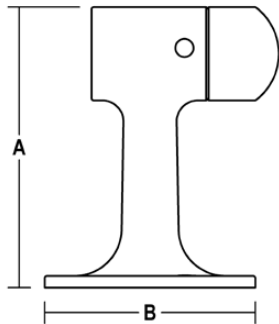

### S109

#### HEAVY DUTY FLOOR STOP

NO.	A	B
S109	3"	Ø 2.5"

**FEATURED FINISHES:** Flat Black (19), Satin Chrome (26D)

**FINISHES:** 10BE, 19, 26D, PC

**MATERIALS:** Cast Brass, Bronze

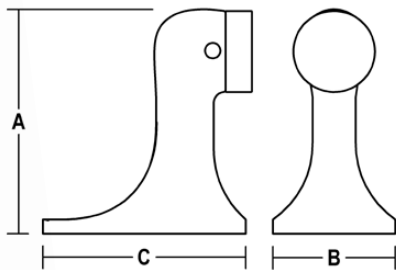

### S110

#### HEAVY DUTY FLOOR STOP

NO.	A	B	C
S110	2.625"	1.5625"	2.5"

**FEATURED FINISHES:** Flat Black (19), Satin Chrome (26D)

**FINISHES:** 10BE, 19, 26D, PC

**MATERIALS:** Cast Brass, Bronze



# DOOR STOPS

## FLOOR STOPS

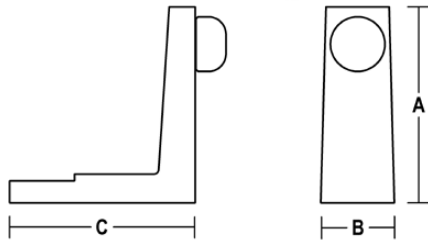

### S113

#### HEAVY DUTY FLOOR STOP

NO.	A	B	C
S113	3.5"	1.3125"	3.375"

**FEATURED FINISHES:** Flat Black (19), Satin Chrome (26D)

**FINISHES:** 10BE, 19, 26D, PC

**MATERIALS:** Cast Brass, Bronze

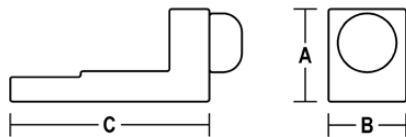

### S114

#### HEAVY DUTY FLOOR STOP

NO.	A	B	C
S114	1.5"	1.3125"	3.375"

**FEATURED FINISHES:** Flat Black (19), Satin Chrome (26D)

**FINISHES:** 10BE, 19, 26D, PC

**MATERIALS:** Cast Brass, Bronze

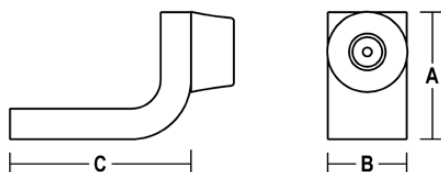

### S115

#### HEAVY DUTY FLOOR STOP

NO.	A	B	C
S115	1.625"	1	2.25"

**FEATURED FINISHES:** Flat Black (19), Satin Stainless (32D)

**FINISHES:** Standard & Custom Available (See Pages 16 & 17)

**MATERIALS:** Aluminum, Brass, Bronze, Stainless Steel



# DOOR STOPS

## FLOOR STOPS

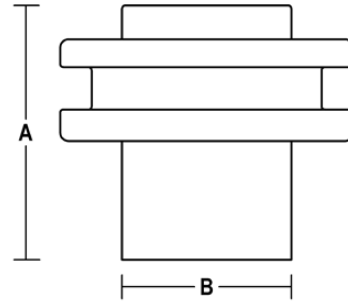

### S116

#### HEAVY DUTY DECORATIVE FLOOR STOP - WIDE DOUBLE RUBBER

NO.	A	B
S116	1.5"	Ø 1"

**FEATURED FINISHES:** Flat Black (19), Satin Stainless (32D)

**FINISHES:** Standard & Custom Available (See Pages 16 & 17)

**MATERIALS:** Aluminum, Brass, Bronze, Stainless Steel

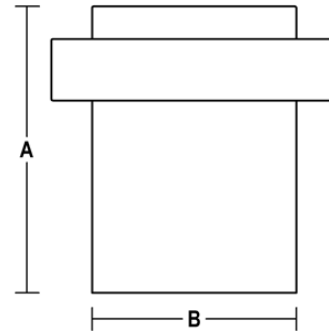

### S117

#### HEAVY DUTY DECORATIVE FLOOR STOP - FLAT BLACK RUBBER

NO.	A	B
S117	1.75"	Ø 1.25"

**FEATURED FINISHES:** Flat Black (19), Satin Stainless (32D)

**FINISHES:** Standard & Custom Available (See Pages 16 & 17)

**MATERIALS:** Aluminum, Brass, Bronze, Stainless Steel



# DOOR STOPS

## FLOOR STOPS

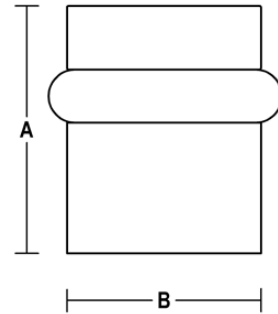

### S118

#### HEAVY DUTY DECORATIVE FLOOR STOP - ROUNDED GREY RUBBER

NO.	A	B
S118	1.5"	Ø 1.1875"

**FEATURED FINISHES:** Flat Black (19), Satin Chrome (26D)

**FINISHES:** Standard & Custom Available (See Pages 16 & 17)

**MATERIALS:** Aluminum, Brass, Bronze, Stainless Steel

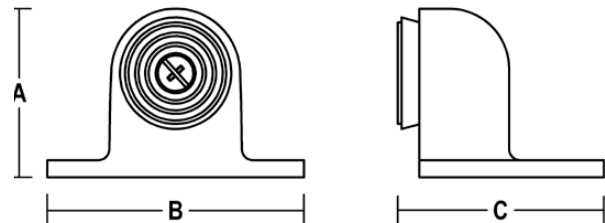

### S142

#### HEAVY DUTY FLOOR STOP

NO.	A	B	C
S142	1.625"	1.75"	2.5"

**FEATURED FINISHES:** Flat Black (19), Satin Chrome (26D)

**FINISHES:** 10BE, 19, 26, 26D, PC

**MATERIALS:** Cast Brass, Rubber



# DOOR STOPS

## WALL STOPS

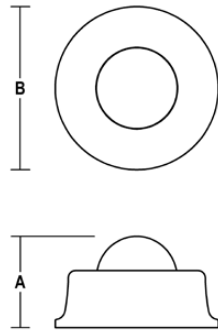

### S119

#### BUTTON WALL STOP

NO.	A	B
S119	0.5625"	Ø 1"

**FEATURED FINISHES:** Flat Black (19), Satin Chrome (26D)

**FINISHES:** 10BE, 19, 26D, PC

**MATERIAL:** Brass

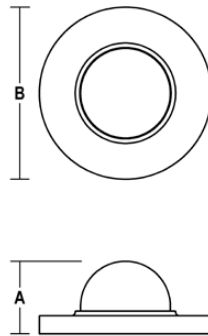

### S120

#### CONVEX CAST WALL STOP

NO.	A	B
S120	1"	Ø 2.5"

**FEATURED FINISHES:** Flat Black (19), Satin Chrome (26D)

**FINISHES:** 3, 4, 10B, 15, 19, 26, 26D

**MATERIAL:** Zinc Die Cast

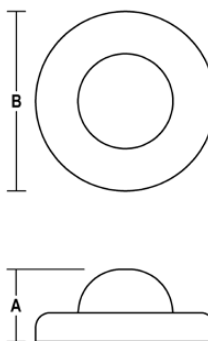

### S121

#### CONVEX WROUGHT WALL STOP

NO.	A	B
S121	1"	Ø 2.5"

**FEATURED FINISHES:** Flat Black (19), Satin Stainless (32D)

**FINISHES:** 19, 26D, 32D

**MATERIALS:** Wrought Brass, Stainless



# DOOR STOPS

## WALL STOPS

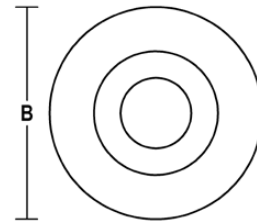

### S122

#### CONCAVE CAST WALL STOP

NO.	A	B
S122	1"	Ø 2.5"

**FEATURED FINISHES:** Flat Black (19), Satin Chrome (26D)

**FINISHES:** 3, 4, 10B, 15, 19, 26, 26D

**MATERIAL:** Zinc Die Cast

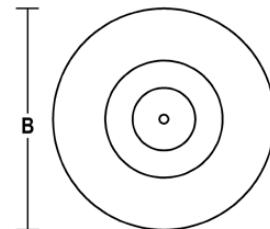

### S123

#### CONCAVE WROUGHT WALL STOP

NO.	A	B
S123	1"	Ø 2.5"

**FEATURED FINISHES:** Flat Black (19), Satin Stainless (32D)

**FINISHES:** 19, 26D, 32D

**MATERIALS:** Wrought Brass, Stainless





# DOOR STOPS

## WALL STOPS

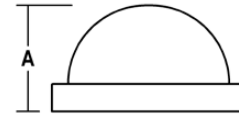
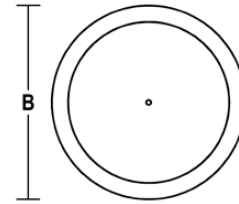

### S128

#### CONVEX RUBBER WALL STOP

NO.	A	B
S128	0.937"	Ø 1.5"

**MATERIAL:** Rubber

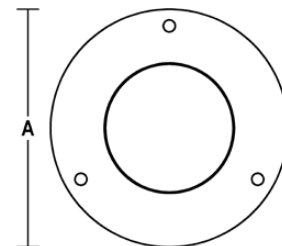

### S147

#### 4" LARGE WALL STOP

NO.	A	B
S147	4"	0.75"

**FEATURED FINISHES:** Flat Black (19), Satin Chrome (26D)

**FINISHES:** Standard & Custom Available (See Pages 16 & 17)

**MATERIALS:** Cast Brass, Rubber



# DOOR STOPS

## BASEBOARD STOPS

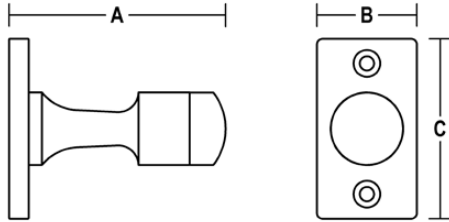

### S129

#### HEAVY DUTY BASEBOARD STOP

NO.	A	B	C
S129	2.75"	1.25"	2.25"

**FEATURED FINISHES:** Flat Black (19), Satin Chrome (26D)

**FINISHES:** 10BE, 19, 26D, PC

**MATERIALS:** Cast Brass, Bronze

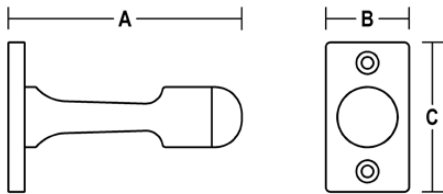

### S130

#### HEAVY DUTY BASEBOARD STOP

NO.	A	B	C
S130	3.5"	1.25"	2.25"

**FEATURED FINISHES:** Flat Black (19), Satin Chrome (26D)

**FINISHES:** 10BE, 19, 26, 26D, PC

**MATERIALS:** Cast Brass, Bronze

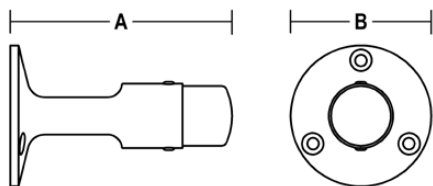

### S131

#### HEAVY DUTY BASEBOARD STOP

NO.	A	B
S131	3.75"	Ø 2.5"

**FEATURED FINISHES:** Flat Black (19), Satin Chrome (26D)

**FINISHES:** 10BE, 19, 26, 26D, PC

**MATERIAL:** Cast Brass



# DOOR STOPS

## DOOR HOLDER

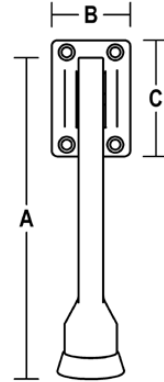

### S111

#### HEAVY DUTY DOOR HOLDER

NO.	A	B	C
S111	5"	1.375"	2"

**FEATURED FINISHES:** Flat Black (19), Satin Chrome (26D)

**FINISHES:** 3, 4, 10BE, 15, 19, 26D, PC

**MATERIAL:** Cast Brass

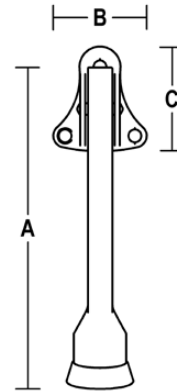
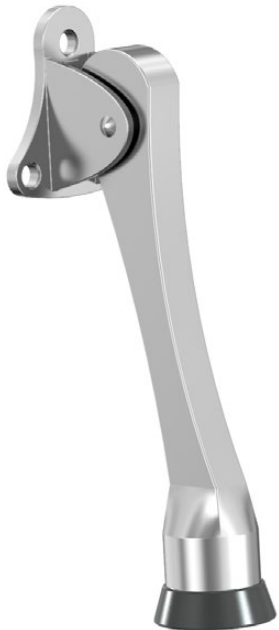

### S112

#### DOOR HOLDER

NO.	A	B	C
S112	4"	1.5"	1.8125"

**FEATURED FINISHES:** Flat Black (19), Satin Chrome (26D)

**FINISHES:** 10BE, 19, 26D, PC

**MATERIAL:** Zinc Die Cast



# FANTOM HARDWARE

---



**206** FANTOM DOOR STOP

**207** FANTOM FIRE DOOR STOP





# FANTOM HARDWARE

## FANTOM DOOR STOP

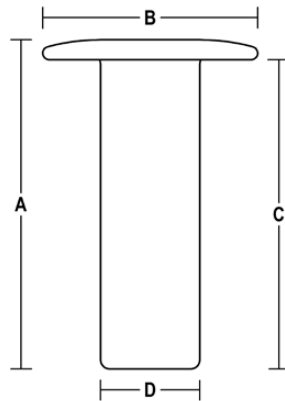

### FANTOM-DS FANTOM DOOR STOP

NO.	A	B	C	D	E
FANTOM-DS	1.8125" (45.75)	1.125" (28)	1.75" (43)	0.5625" (13.8)	Strike: 1.3125" (33) x 3.15" (80)

**FEATURED FINISHES:** Satin, Black, Clear

**FINISHES:** Satin, Chrome, Brass, Black, White, Clear

**NOTES:** Trip-Hazard Free, Fully Concealed, Hold-Open Feature, Magnetic Doorstop



# FANTOM HARDWARE

## FANTOM FIRE DOOR STOP

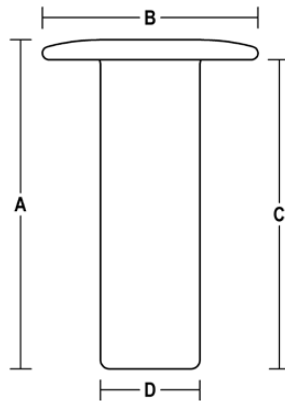

### FANTOM-F FANTOM FIRE DOOR STOP

NO.	A	B	C	D	E
FANTOM-F	1.8125" (45.75)	1.125" (28)	1.75" (43)	0.5625" (13.8)	Strike: 1.93" (49) x 2.36" (60)

**FEATURED FINISHES:** Satin, Chrome, Clear

**FINISHES:** Satin, Chrome, Clear

**NOTES:** Fire-Rated, Trip-Hazard Free, No Hold-Open, Magnetic Doorstop





# DOOR ACCESSORIES

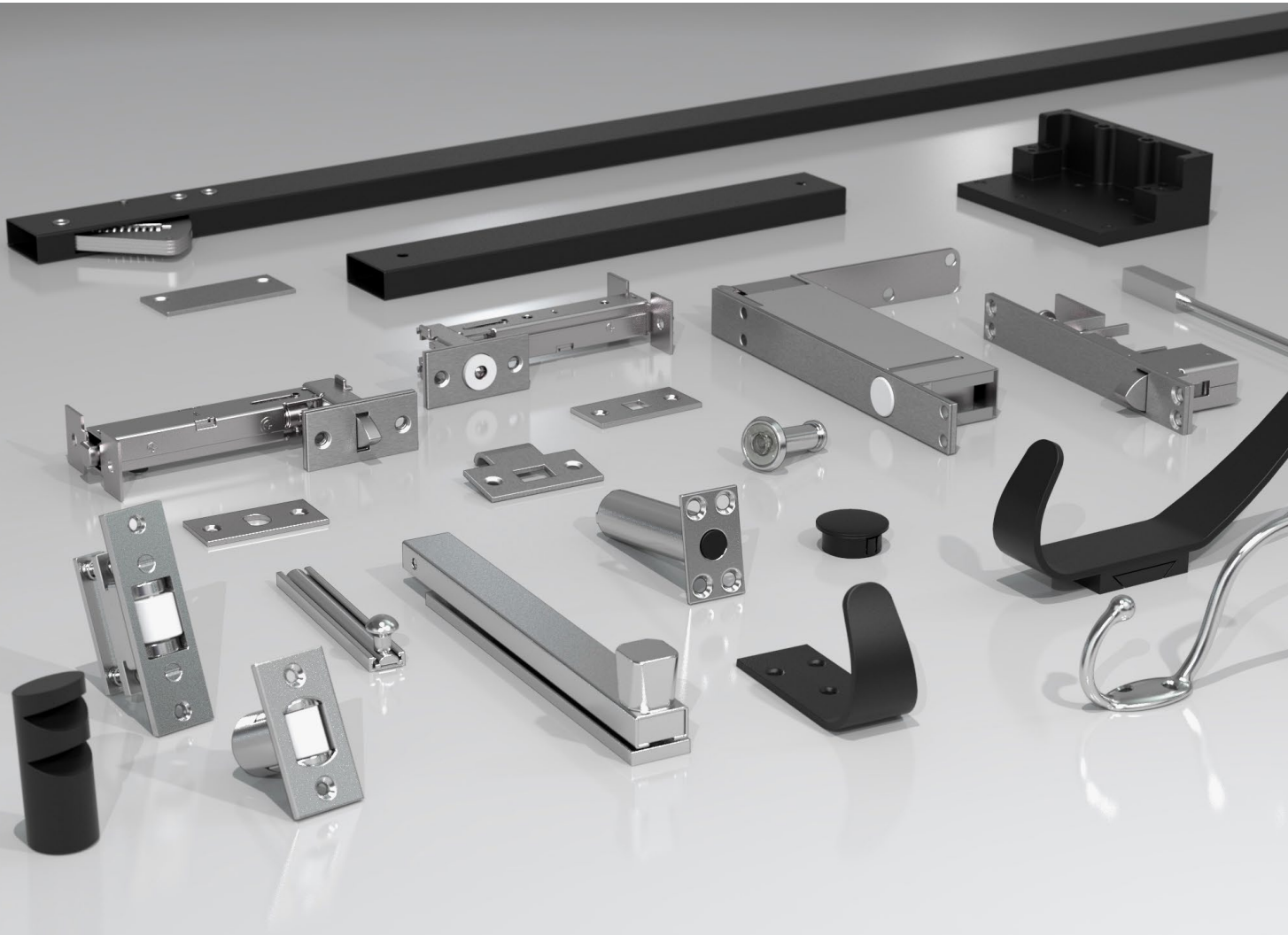

**210** FLUSH BOLTS

**219** DOOR COORDINATORS

**222** SURFACE BOLTS

**224** ROLLER LATCHES

**228** DOOR VIEWERS

**229** COAT HOOKS





# DOOR ACCESSORIES

## FLUSH BOLTS



### F64UL

#### MANUAL FLUSH BOLT - WOOD DOORS

**FEATURED FINISHES:** Flat Black (19), Satin Chrome (26D)

**FINISHES:** Standard & Custom Available (See Pages 16 & 17)

**NOTES:** UL Listed

NO	FACE	PLATE THICKNESS	BOLT LENGTH	THROW	STRIKE
F64UL	1" X 6.75"	0.125"	1.125"	0.875"	0.9375" X 2.25"



### F65UL

#### MANUAL FLUSH BOLT - METAL DOORS

**FEATURED FINISHES:** Flat Black (19), Satin Chrome (26D)

**FINISHES:** Standard & Custom Available (See Pages 16 & 17)

**NOTES:** UL Listed • Available rod lengths: 12" (Standard), 24", 36", and custom

NO	FACE	STRIKE 1	STRIKE 2	ROD	THROW	PLATE THICKNESS	BOLT LENGTH
F65UL	1" X 6.75"	1" X 2"	0.9375" X 2.25"	12"	0.875"	0.085"	1.125"



# DOOR ACCESSORIES

## FLUSH BOLTS

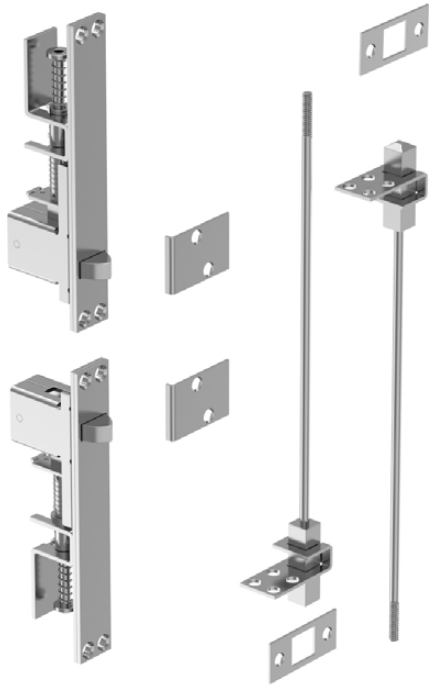

### F7842 AUTOMATIC FLUSH BOLT SET - METAL DOORS

- FEATURED FINISHES:** Flat Black (19), Satin Chrome (26D)  
**FINISHES:** Standard & Custom Available (See Pages 16 & 17)  
**NOTES:** Sold in Pairs • UL Listed • Non Handed • Min 5lbs of Force Needed to Drive Bolt • Bolts Are Adjustable for Unusual Clearance  
 • Auto Thermal Lock is Triggered Under High Heat Conditions  
 • Reversible Top and Bottom Bolt Guide

NO	FACE	STRIKE 1	STRIKE 2	GUIDE	ROD	PLATE THICKNESS	THROW	BOLT LENGTH
F7842	1" X 6.75"	0.9375" X 2.25"	1.3125" X 1.8125"	1" X 2" X 0.6"	9"	0.125"	0.75"	2"

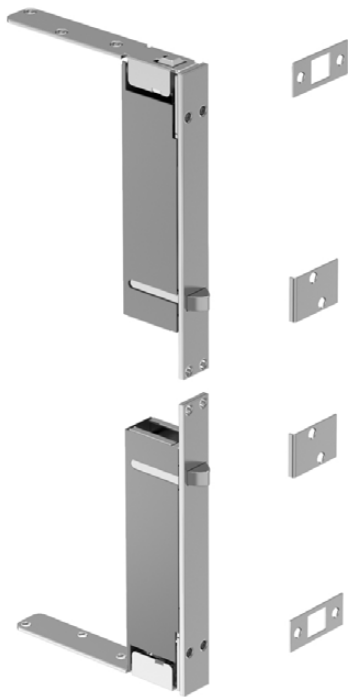

### F7942 AUTOMATIC FLUSH BOLT SET - WOOD DOORS

- FEATURED FINISHES:** Flat Black (19), Satin Chrome (26D)  
**FINISHES:** Standard & Custom Available (See Pages 16 & 17)  
**NOTES:** Sold in Pairs • UL Listed • Non Handed • Min 5lbs of Force Needed to Drive Bolt • Bolts Are Adjustable for Unusual Clearance  
 • Auto Thermal Lock is Triggered Under High Heat Conditions • Top and Bottom Bolt Guide

NO	FACE	TOP PLATE	STRIKE 1	STRIKE 2	PLATE THICKNESS	THROW	DUST COVER
F7942	1" X 8.4375"	1" X 6"	0.9375" X 2.25"	1.25" X 1.75"	0.125"	0.75"	2" X 7"



# DOOR ACCESSORIES

## FLUSH BOLTS

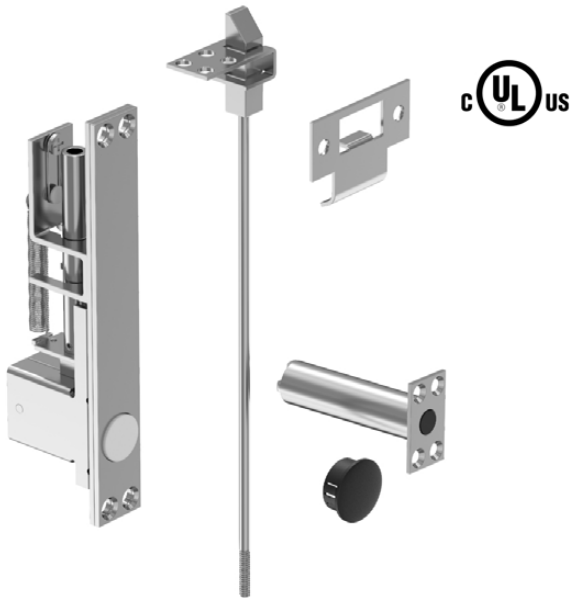

### F7805/FB

#### SELF-LATCHING FLUSH BOLT & FIRE BOLT - METAL DOORS

**FEATURED FINISHES:** Flat Black (19), Satin Chrome (26D)

**FINISHES:** Standard & Custom Available (See Pages 16 & 17)

• Fire Bolt: 26D

**NOTES:** UL Listed • Latches automatically when inactive door is closed • Bolt stays latched until button is pressed on the bolt face • The fire bolt replaces the need for a bottom automatic flush bolt and dust proof strike

NO	FACE	STRIKE	GUIDE	ROD	PLATE THICKNESS	THROW	BOLT LENGTH
F7805/FB	1" X 6.75"	1.125" X 2.75" (0.75" X 1.5" LIP)	1" X 2" X 0.6"	9"	0.125"	0.75"	1.875"



### F7840/FB

#### AUTOMATIC FLUSH BOLT & FIRE BOLT - METAL DOORS

**FEATURED FINISHES:** Flat Black (19), Satin Chrome (26D)

**FINISHES:** Standard & Custom Available (See Pages 16 & 17)

• Fire Bolt: 26D

**NOTES:** UL Listed • Non Handed • Min 5lbs of Force Needed to Drive Bolt • Bolts Are Adjustable for Unusual Clearance • Auto Thermal Lock is Triggered Under High Heat Conditions • The fire bolt replaces the need for a bottom automatic flush bolt and dust proof strike

NO	FACE	STRIKE 1	STRIKE 2	GUIDE	ROD	PLATE THICKNESS	THROW	BOLT LENGTH
F7840/FB	1" X 6.75"	0.9375" X 2.25"	1.3125" X 1.8125"	1" X 2" X 0.6"	9"	0.125"	0.75"	2"



# DOOR ACCESSORIES

## FLUSH BOLTS



### F7905/FB

#### SELF-LATCHING FLUSH BOLT & FIRE BOLT - WOOD DOORS

**FEATURED FINISHES:** Flat Black (19), Satin Chrome (26D)

**FINISHES:** Standard & Custom Available (See Pages 16 & 17)

• Fire Bolt: 26D

**NOTES:** UL Listed • Latches automatically when inactive door is closed • Bolt stays latched until button is pressed on the bolt face  
• The fire bolt replaces the need for a bottom automatic flush bolt and dust proof strike

NO	FACE	TOP PLATE	STRIKE	PLATE THICKNESS	THROW	DUST COVER
F7905/FB	1" X 8.4375"	1" X 6"	1.125" X 2.75" (0.75" X 1.5" LIP)	0.125"	0.75"	2" X 7"



### F7940/FB

#### AUTOMATIC FLUSH BOLT & FIRE BOLT - WOOD DOORS

**FEATURED FINISHES:** Flat Black (19), Satin Chrome (26D)

**FINISHES:** Standard & Custom Available (See Pages 16 & 17)

• Fire Bolt: 26D

**NOTES:** UL Listed • Non Handed • Min 5lbs of Force Needed to Drive Bolt • Bolts Are Adjustable for Unusual Clearance • Auto Thermal Lock is Triggered Under High Heat Conditions  
• The fire bolt replaces the need for a bottom automatic flush bolt and dust proof strike

NO	FACE	TOP PLATE	STRIKE 1	STRIKE 2	PLATE THICKNESS	THROW	DUST COVER
F7940/FB	1" x 8.4375"	1" X 6"	0.9375" X 2.25"	1.25" X 1.75"	0.125"	0.75"	2" X 7"



# DOOR ACCESSORIES

## FLUSH BOLTS

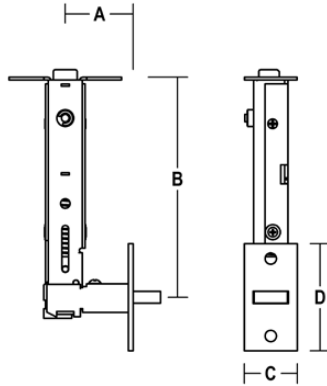

### F7960/FB

#### UNIVERSAL AUTOMATIC FLUSH BOLT & FIRE BOLT - WOOD OR METAL DOORS

**FEATURED FINISHES:** Flat Black (19),  
Satin Chrome (26D)

**FINISHES:** Standard & Custom Available  
(See Pages 16 & 17) • Fire Bolt: 26D

**NOTES:** UL Listed • Bolt automatically retracts when active door is opened • Fire bolt replaces the need for a bottom automatic flush bolt and dust proof strike • Intended for use with: Hollow-metal doors rated up to 3 hours; wood/plastic-covered composite doors rated up to and including 1-1/2 hours; and wood core doors rated 20 mins. • For applications of more than 1-1/2 hours, hollow-metal doors shall be provided with an overlapping astragal.

NO	A	B	C	D	FRAME STRIKE	ACTIVE DOOR STRIKE
F7960/FB	1.5"	4.7187"	1.0937"	2.25"	1.0937" X 2.25"	1.125" X 1.75"

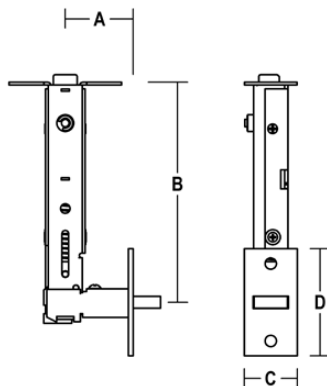

### F7962

#### UNIVERSAL AUTOMATIC FLUSH BOLT SET

**FEATURED FINISHES:** Flat Black (19),  
Satin Chrome (26D)

**FINISHES:** Standard & Custom Available  
(See Pages 16 & 17)

**NOTES:** UL Listed • Bolt automatically retracts when active door is opened. • Intended for use with: Hollow-metal doors rated up to 3 hours; wood/plastic-covered composite doors rated up to and including 1-1/2 hours; and wood core doors rated 20 mins. • For applications of more than 1-1/2 hours, hollow-metal doors shall be provided with an overlapping astragal.

NO	A	B	C	D	FRAME STRIKE	ACTIVE DOOR STRIKE
F7962	1.5"	4.7187"	1.0937"	2.25"	1.0937" X 2.25"	1.125" X 1.75"



# DOOR ACCESSORIES

## FLUSH BOLTS

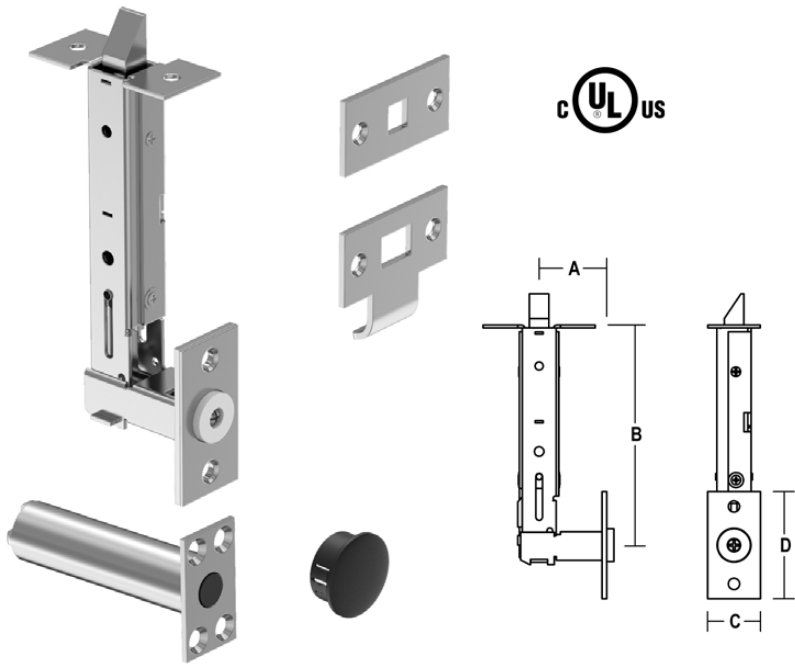

### F7970/FB

#### UNIVERSAL SINGLE SELF-LATCHING FLUSH BOLT & FIRE BOLT - WOOD OR METAL DOORS

**FEATURED FINISHES:** Flat Black (19), Satin Chrome (26D)

**FINISHES:** Standard & Custom Available (See Pages 16 & 17) • Fire Bolt: 26D

**NOTES:** UL Listed • Latches automatically when inactive door is closed • Bolt stays latched until button is pressed on the bolt face • Fire bolt replaces the need for a bottom automatic flush bolt and dust proof strike • Intended for use with: Hollow-metal doors rated up to 3 hours; wood/plastic-covered composite doors rated up to and including 1-1/2 hours; and wood core doors rated 20 mins. • For applications of more than 1-1/2 hours, hollow-metal doors shall be provided with an overlapping astragal.

NO	A	B	C	D	FRAME STRIKE	BOLT HEAD GUIDE
F7970/FB	1.5"	4.7187"	1.0937"	2.25"	1.0937" X 2.25" (LIP 1" X 0.75")	1.0937" X 2.25"

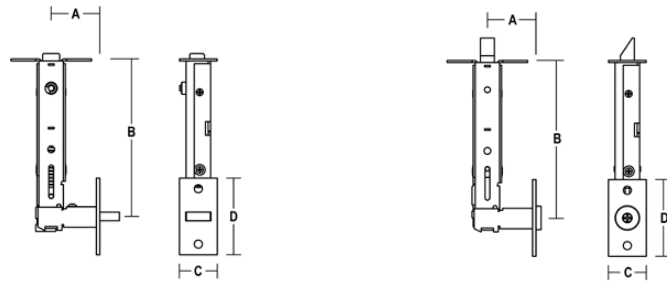

### F7975

#### COMBINATION UNIVERSAL FLUSH BOLTS

**FEATURED FINISHES:** Flat Black (19), Satin Chrome (26D)

**FINISHES:** Standard & Custom Available (See Pages 16 & 17)

**NOTES:** UL Listed • Top bolt latches automatically when inactive door is closed • Top bolt stays latched until button is pressed on the bolt face • Bottom bolt automatically retracts when active door is opened • Intended for use with: Hollow-metal doors rated up to 3 hours; wood/plastic-covered composite doors rated up to and including 1-1/2 hours; and wood core doors rated 20 mins. • For applications of more than 1-1/2 hours, hollow-metal doors shall be provided with an overlapping astragal.

#### TOP BOLT: SELF-LATCHING FLUSH BOLT

NO	A	B	C	D	FRAME STRIKE	BOLT HEAD GUIDE
F7970	1.5"	4.7187"	1.0937"	2.25"	1.0937" X 2.25" (LIP 1" X 0.75")	1.0937" X 2.25"

#### BOTTOM BOLT: AUTOMATIC FLUSH BOLT

NO	A	B	C	D	FRAME STRIKE	ACTIVE DOOR STRIKE
F7960	1.5"	4.7187"	1.0937"	2.25"	1.0937" X 2.25"	1.125" X 1.75"



# DOOR ACCESSORIES

## FLUSH BOLTS

### F7845

#### COMBINATION FLUSH BOLTS - METAL DOORS (F7805 + F7840)

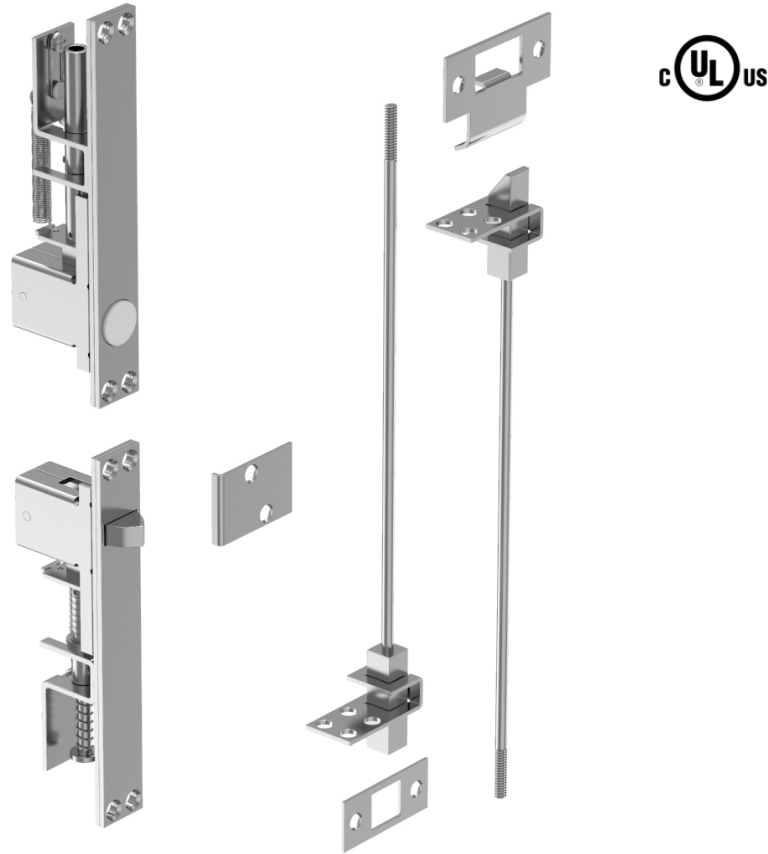

#### TOP BOLT: SELF LATCHING FLUSH BOLT

NO	FACE	STRIKE	GUIDE	ROD	PLATE THICKNESS	THROW	BOLT LENGTH
F7805	1" X 6.75"	1.125" X 2.75" (0.75" X 1.5" LIP)	1" X 2" X 0.6"	9"	0.125"	0.75"	2"

#### BOTTOM BOLT: AUTOMATIC FLUSH BOLT

NO	FACE	STRIKE 1	STRIKE 2	GUIDE	ROD	PLATE THICKNESS	THROW	BOLT LENGTH
F7840	1" X 6.75"	0.9375" X 2.25"	1.3125" X 1.8125"	1" X 2" X 0.6"	9"	0.125"	0.75"	2"

**FEATURED FINISHES:** Flat Black (19), Satin Chrome (26D)

**FINISHES:** Standard & Custom Available (See Pages 16 & 17)

**NOTES:** Sold in Pairs • UL Listed • Automatic Bolt on Bottom of Door, Self Latching Bolt at Top of Door • Latches automatically when inactive door is closed • Top bolt stays latched until button is pressed on the bolt face • Bottom bolt automatically retracts when active door is opened.





# DOOR ACCESSORIES

## FLUSH BOLTS

### F7945

### COMBINATION FLUSH BOLTS - WOOD DOORS (F7905 + F7940)

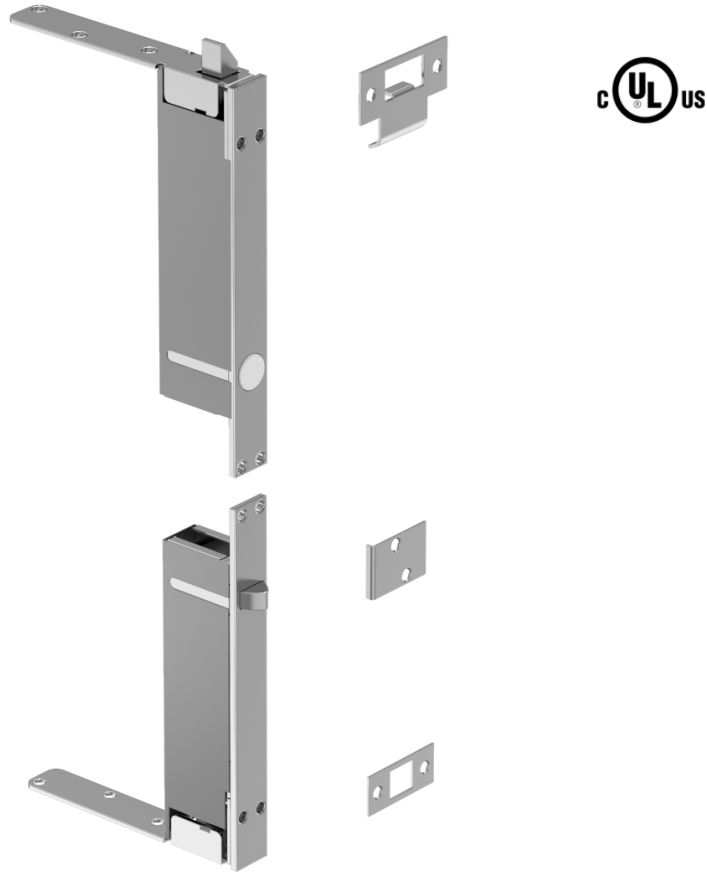

#### TOP BOLT: SELF LATCHING FLUSH BOLT

NO	FACE	TOP PLATE	STRIKE	PLATE THICKNESS	THROW	DUST COVER
F7905	1" X 8.4375"	1" X 6"	1.125" X 2.75" (0.75" X 1.5" LIP)	0.125"	0.75"	2" X 7"

#### BOTTOM BOLT: AUTOMATIC FLUSH BOLT

NO	FACE	TOP PLATE	STRIKE 1	STRIKE 2	PLATE THICKNESS	THROW	DUST COVER
F7940	1" X 8.4375"	1" X 6"	0.9375" X 2.25"	1.25" X 1.75"	0.125"	0.75"	2" X 7"

**FEATURED FINISHES:** Flat Black (19), Satin Chrome (26D)

**FINISHES:** Standard & Custom Available (See Pages 16 & 17)

**NOTES:** Sold in Pairs • UL Listed • Automatic Bolt on Bottom of Door, Self Latching Bolt at Top of Door • Latches automatically when inactive door is closed • Top bolt stays latched until button is pressed on the bolt face • Bottom bolt automatically retracts when active door is opened.



# DOOR ACCESSORIES

## FLUSH BOLTS

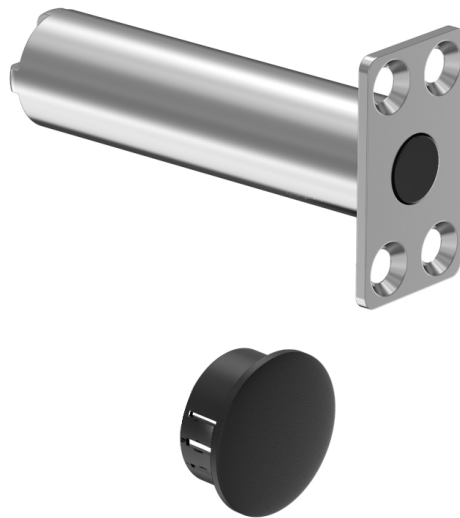

**FB**  
**UNIVERSAL AUXILIARY FIRE BOLT**  
**- WOOD OR METAL DOORS**

**FEATURED FINISHES:** Satin Chrome (26D)

**FINISHES:** 26D

**NOTES:** Replaces the need for a bottom automatic flush bolt and dust proof strike • When door is subjected to 230°F the plug and gray plastic cover will melt allowing the bolt to project, locking the leaves together • UL Listed only when used with automatic or self latching top bolt

NO	FACE	PLATE THICKNESS	LENGTH
FB	1" X 1.8"	0.085"	3.375"



# DOOR ACCESSORIES

## DOOR COORDINATORS

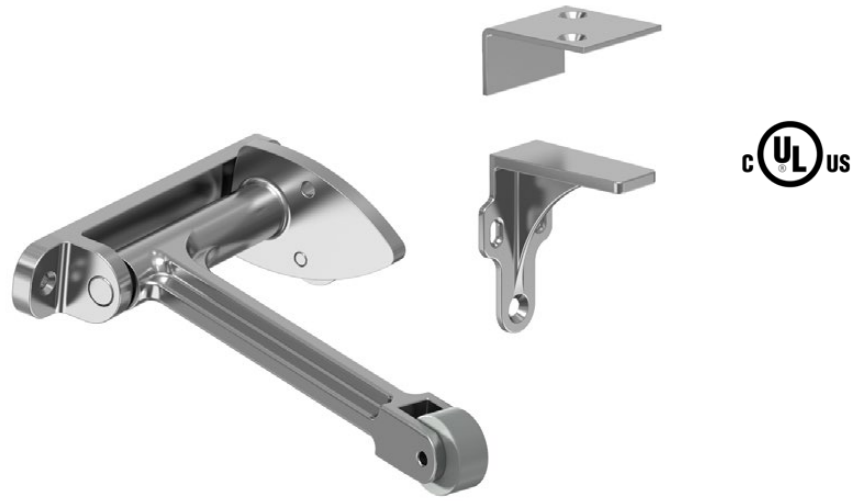

### **F500**

#### **GRAVITY TYPE DOOR COORDINATOR**

**FEATURED FINISHES:** Satin Chrome (26D)

**FINISHES:** 26D

**NOTES:** UL Listed

<b>NO</b>	<b>WIDTH</b>	<b>PROJECTION</b>	<b>L-STRIKE PLATE</b>	<b>ADJ DOOR BRACKET</b>
<b>F500</b>	5.5625"	6.5"	1.5" X 1.725" X 0.9"	1.35" X 2.5" X 2"



# DOOR ACCESSORIES

## DOOR COORDINATORS

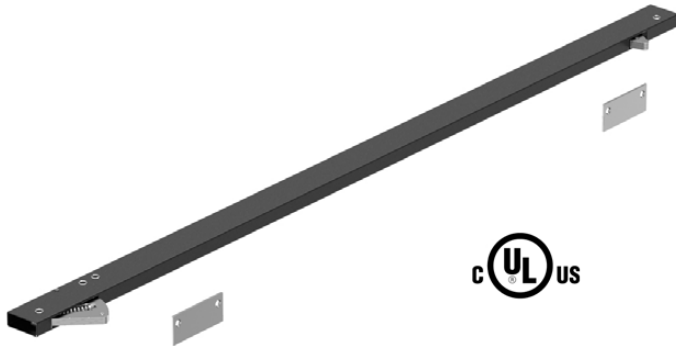

### F7600-NX

#### 42" SURFACE COORDINATOR W/ FILLER (48"-54" OPENING)

**FEATURED FINISHES:** Flat Black (19)

**FINISHES:** 10BE, 19, 34, P, PC

**NOTES:** UL Listed • Non-handed • Override protection to prevent damage in case of abnormal force on door • Mechanism and filler bar completely fill width of opening and when painted to match frame it becomes virtually invisible.

NO	PRODUCT NAME	LENGTH	WIDTH	HEIGHT
F7648-NX - F7654-NX	42" SURFACE COORDINATOR W/ FILLER	42"	1.65"	0.65"

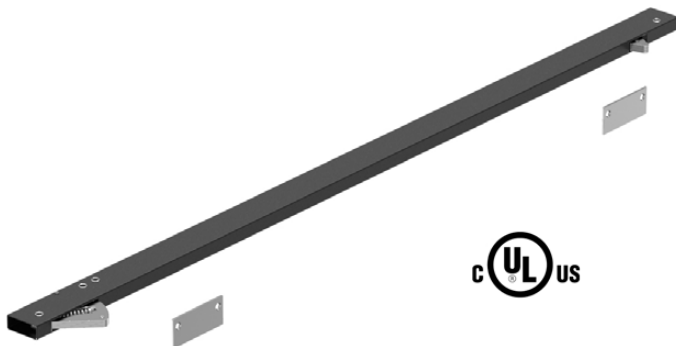

### F7600

#### 52" SURFACE COORDINATOR W/ FILLER (54" - 96" OPENING)

**FEATURED FINISHES:** Flat Black (19)

**FINISHES:** 10BE, 19, 34, P, PC

**NOTES:** UL Listed • Non-handed • Override protection to prevent damage in case of abnormal force on door • Mechanism and filler bar completely fill width of opening and when painted to match frame it becomes virtually invisible.

NO	PRODUCT NAME	LENGTH	WIDTH	HEIGHT
F7654-F7664	52" SURFACE COORDINATOR W/ 12" FILLER	52"	1.65"	0.65"
F7665-F7672	52" SURFACE COORDINATOR W/ 20" FILLER	52"	1.65"	0.65"
F7673-F7688	52" SURFACE COORDINATOR W/ 36" FILLER	52"	1.65"	0.65"
F7679-F7696	52" SURFACE COORDINATOR W/ 48" FILLER	52"	1.65"	0.65"



# DOOR ACCESSORIES

## DOOR COORDINATORS

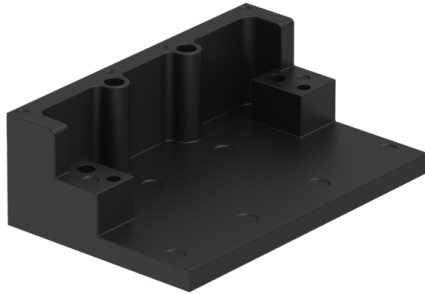

### F7601AB

#### AB MOUNTING BRACKET FOR TOP STOP / SOFFIT WIDTH 7/8" TO 2-1/4"

**FEATURED FINISHES:** Flat Black (19)

**FINISHES:** 10BE, 19, 34, P, PC

**NOTES:** UL Listed

NO	LENGTH	WIDTH	HEIGHT
F7601AB	3.25"	5"	1.65"

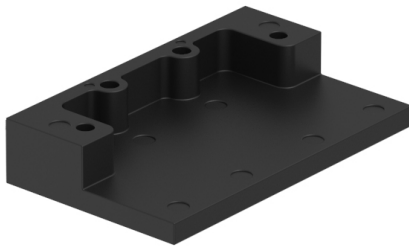

### F7601C

#### C MOUNTING BRACKET FOR TOP STOP / SOFFIT WIDTH OVER 2-1/4"

**FEATURED FINISHES:** Flat Black (19)

**FINISHES:** 10BE, 19, 34, P, PC

**NOTES:** UL Listed

NO	LENGTH	WIDTH	HEIGHT
F7601C	3"	5"	0.9687"

### FILLBAR FILLER BAR

**FEATURED FINISHES:** Flat Black (19)

**FINISHES:** 10BE, 19, 34, P, PC

**NOTES:** Filler bar is supplied no charge with the F7600 series coordinators



NO	LENGTH	WIDTH	HEIGHT
FILLBAR12	12"	1.65"	0.65"
FILLBAR20	20"	1.65"	0.65"
FILLBAR36	36"	1.65"	0.65"
FILLBAR48	48"	1.65"	0.65"



# DOOR ACCESSORIES

## SURFACE BOLTS



### F67UL HEAVY DUTY SURFACE BOLT

NO.	FACE	STRIKE1	STRIKE2	THROW
F67UL	0.9375" X 8"	1" X 3.375"	1" X 2.25"	1"

**FEATURED FINISHES:** Flat Black (19), Satin Chrome (26D), Antimicrobial (AM)

**FINISHES:** Standard & Custom Available (See Pages 16 & 17)

**NOTES:** UL Listed • Top and Bottom Strike Included



# DOOR ACCESSORIES

## SURFACE BOLTS



### F69 SURFACE BOLT

NO.	LENGTH	STRIKE1	STRIKE2	THROW
F69	4"	0.75" X 1"	0.5" X 1.5"	0.5"

**FEATURED FINISHES:** Flat Black (19), Satin Chrome (26D), Antimicrobial (AM)

**FINISHES:** Standard & Custom Available (See Pages 16 & 17)

**NOTES:** Universal and Mortise Strikes Included

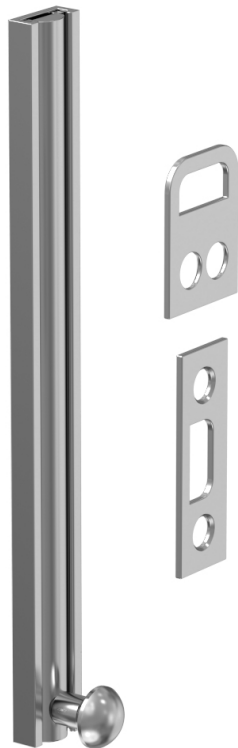

### F70 SURFACE BOLT

NO.	LENGTH	STRIKE1	STRIKE2	THROW
F70	6"	0.75" X 1"	0.5" X 1.5"	0.5"

**FEATURED FINISHES:** Flat Black (19), Satin Chrome (26D), Antimicrobial (AM)

**FINISHES:** Standard & Custom Available (See Pages 16 & 17)

**NOTES:** Universal and Mortise Strikes Included



# DOOR ACCESSORIES

## ROLLER LATCHES



### F75

#### HEAVY DUTY ROLLER LATCH W/ T-STRIKE

NO.	FACE	DEPTH	PLATE	
			THICKNESS	STRIKE
F75	1" X 3.4375"	1.625"	0.1562"	1.1562" X 2.7812"

**FEATURED FINISHES:** Flat Black (19), Satin Chrome (26D)

**FINISHES:** Standard & Custom Available (See Pages 16 & 17)

**MATERIAL:** Cast Brass

**PRODUCT OPTIONS:** Stainless Roller Optional

**NOTES:** Fully Adjustable Roller for Various Door Clearances, Nylon Roller



### F76

#### HEAVY DUTY ROLLER LATCH W/ ASA STRIKE

NO.	FACE	DEPTH	PLATE	
			THICKNESS	STRIKE
F76	1" X 3.4375"	1.625"	0.1562"	1.25" X 4.9062"

**FEATURED FINISHES:** Flat Black (19), Satin Chrome (26D)

**FINISHES:** Standard & Custom Available (See Pages 16 & 17)

**MATERIAL:** Cast Brass

**PRODUCT OPTIONS:** Stainless Roller Optional

**NOTES:** Fully Adjustable Roller for Various Door Clearances, Nylon Roller





# DOOR ACCESSORIES

## ROLLER LATCHES

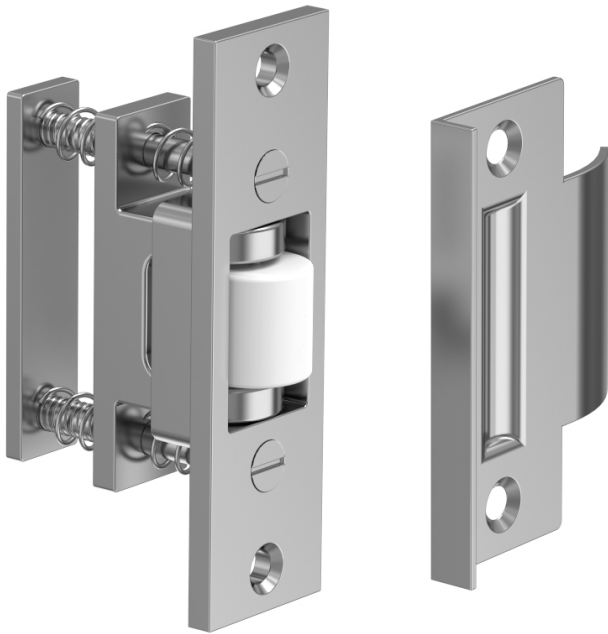

### F77

#### HEAVY DUTY ROLLER LATCH W/ ANGLE STOP STRIKE

NO.	FACE	DEPTH	PLATE	
			THICKNESS	STRIKE
F77	1" X 3.4375"	1.625"	0.1562"	1.625" X 2.75"

**FEATURED FINISHES:** Flat Black (19), Satin Chrome (26D)

**FINISHES:** Standard & Custom Available (See Pages 16 & 17)

**MATERIAL:** Cast Brass

**PRODUCT OPTIONS:** Stainless Roller Optional

**NOTES:** Fully Adjustable Roller for Various Door Clearances, Nylon Roller



### F78

#### HEAVY DUTY ROLLER LATCH W/ CAST STRIKE

NO.	FACE	DEPTH	PLATE	
			THICKNESS	STRIKE
F78	1" X 3.4375"	1.625"	0.1562"	1.6875" X 2.25"

**FEATURED FINISHES:** Flat Black (19), Satin Chrome (26D)

**FINISHES:** Standard & Custom Available (See Pages 16 & 17)

**MATERIAL:** Cast Brass

**PRODUCT OPTIONS:** Stainless Roller Optional

**NOTES:** Fully Adjustable Roller for Various Door Clearances, Nylon Roller



# DOOR ACCESSORIES

## ROLLER LATCHES



### F79

#### HEAVY DUTY ANGLE STOP ROLLER LATCH

NO.	FACE	DEPTH	PLATE	
			THICKNESS	STRIKE
F79	1.5" X 4.5"	1.625"	0.1875"	1.125" X 2.25"

**FEATURED FINISHES:** Flat Black (19), Satin Chrome (26D)

**FINISHES:** Standard & Custom Available (See Pages 16 & 17)

**MATERIAL:** Cast Brass

**PRODUCT OPTIONS:** Stainless Roller Optional

**NOTES:** Fully Adjustable Roller for Various Door Clearances, Nylon Roller

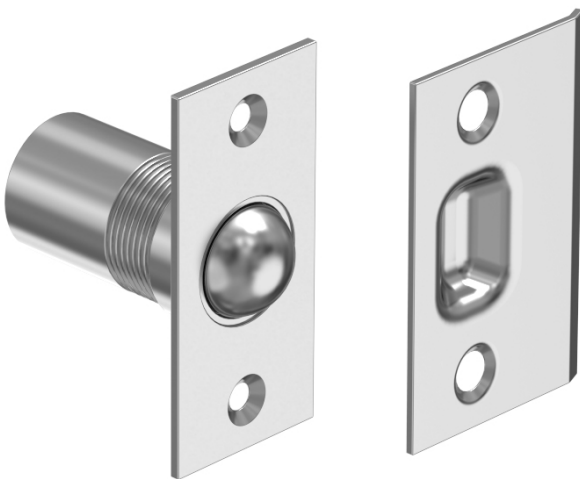

### F80

#### BALL CATCH

NO.	FACE	DEPTH	PLATE	
			THICKNESS	STRIKE
F80	1" X 2.125"	1.4375"	0.06"	2.125" X 1.375"

**FEATURED FINISHES:** Flat Black (19), Satin Chrome (26D)

**FINISHES:** Standard & Custom Available (See Pages 16 & 17)

**MATERIAL:** Cast Brass



# DOOR ACCESSORIES

## ROLLER LATCHES



### F89

#### ADJUSTABLE ROLLER LATCH W/ T-STRIKE

NO.	FACE	STRIKE
F89	1.1875" X 2.25"	1.125" X 2.75"

**FEATURED FINISHES:** Flat Black (19), Satin Chrome (26D)

**FINISHES:** Standard & Custom Available (See Pages 16 & 17)

**MATERIAL:** Cast Brass

**NOTES:** Fully Adjustable Roller for Various Door Clearances, Nylon Roller



### F90

#### ADJUSTABLE ROLLER LATCH W/ ASA STRIKE

NO.	FACE	STRIKE
F90	1.1875" X 2.25"	1.25" X 4.875"

**FEATURED FINISHES:** Flat Black (19), Satin Chrome (26D)

**FINISHES:** Standard & Custom Available (See Pages 16 & 17)

**MATERIAL:** Cast Brass

**NOTES:** Fully Adjustable Roller for Various Door Clearances, Nylon Roller



# DOOR ACCESSORIES

## DOOR VIEWERS

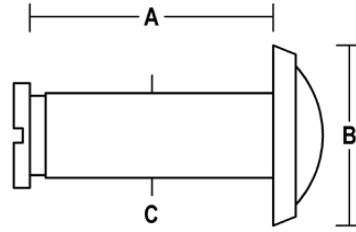

**F92**  
**DOOR VIEWER**

NO.	A	B	C
F92	ADJUSTABLE 1.375" - 2.25"	1"	Ø 0.47"

**FEATURED FINISHES:** Satin Chrome (26D)

**FINISHES:** Standard & Custom Available (See Pages 16 & 17)

**NOTES:** UL Listing Available, For 1.5" to 2.125" Door Thickness

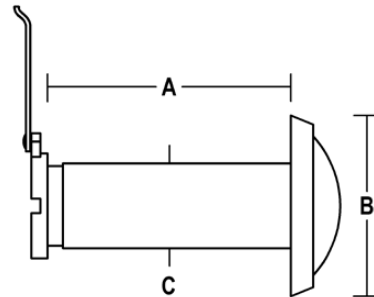

**F93**  
**DOOR VIEWER W/ PRIVACY COVER**

NO.	A	B	C
F93	ADJUSTABLE 1.375" - 2.25"	1"	Ø 0.47"

**FEATURED FINISHES:** Satin Chrome (26D)

**FINISHES:** Standard & Custom Available (See Pages 16 & 17)

**NOTES:** UL Listing Available, For 1.5" to 2.125" Door Thickness



# DOOR ACCESSORIES

## COAT HOOKS

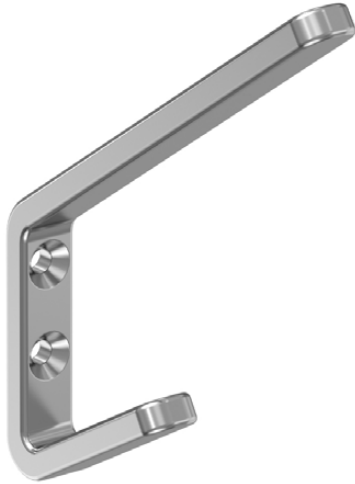

### P140

#### ANGLED HAT AND COAT HOOK

NO.	PROJECTION	HEIGHT	MATERIAL
P140	4"	4.5"	0.25" X 0.5"

**FEATURED FINISHES:** Flat Black (19), Satin Stainless (32D)

**FINISHES:** Standard & Custom Available (See Pages 16 & 17)

**MATERIALS:** Aluminum, Brass, Bronze, Stainless Steel



### P141

#### ANGLED COAT HOOK

NO.	PROJECTION	HEIGHT	MATERIAL
P141	1.875"	2.5"	0.25" X 0.5"

**FEATURED FINISHES:** Flat Black (19), Satin Stainless (32D)

**FINISHES:** Standard & Custom Available (See Pages 16 & 17)

**MATERIALS:** Aluminum, Brass, Bronze, Stainless Steel



# DOOR ACCESSORIES

## COAT HOOKS



### P142

#### CURVED HAT AND COAT HOOK - LARGE

NO.	PROJECTION	HEIGHT
P142	3.625"	4.5"

**FEATURED FINISHES:** Flat Black (19), Satin Chrome (26D)

**FINISHES:** Standard & Custom Available (See Pages 16 & 17)

**MATERIAL:** Zinc Die Cast



### P143

#### CURVED HAT AND COAT HOOK - SMALL

NO.	PROJECTION	HEIGHT
P143	2.375"	3.5"

**FEATURED FINISHES:** Flat Black (19), Satin Chrome (26D)

**FINISHES:** Standard & Custom Available (See Pages 16 & 17)

**MATERIAL:** Zinc Die Cast



# DOOR ACCESSORIES

## COAT HOOKS



**P146**  
**MODERN HAT AND COAT HOOK**  
**W/ EXPOSED MTG**

NO.	PROJECTION	HEIGHT
P146	2.5"	6.25"

**FEATURED FINISHES:** Flat Black (19), Satin Stainless (32D)

**FINISHES:** Standard & Custom Available (See Pages 16 & 17)

**MATERIALS:** Aluminum, Brass, Bronze, Stainless Steel



**P147**  
**MODERN COAT HOOK W/ EXPOSED MTG**

NO.	PROJECTION	HEIGHT
P147	2.25"	3.25"

**FEATURED FINISHES:** Flat Black (19), Satin Stainless (32D)

**FINISHES:** Standard & Custom Available (See Pages 16 & 17)

**MATERIALS:** Aluminum, Brass, Bronze, Stainless Steel



# DOOR ACCESSORIES

## COAT HOOKS



**P148**  
**MODERN HAT AND COAT HOOK**  
**W/ CONCEALED MTG**

NO.	PROJECTION	HEIGHT
P148	3"	6.25"

**FEATURED FINISHES:** Flat Black (19), Satin Stainless (32D)

**FINISHES:** Standard & Custom Available (See Pages 16 & 17)

**MATERIALS:** Aluminum, Brass, Bronze, Stainless Steel



**P149**  
**MODERN CONCEALED COAT HOOK**  
**W/ CONCEALED MTG**

NO.	PROJECTION	HEIGHT
P149	2.75"	3.25"

**FEATURED FINISHES:** Flat Black (19), Satin Stainless (32D)

**FINISHES:** Standard & Custom Available (See Pages 16 & 17)

**MATERIALS:** Aluminum, Brass, Bronze, Stainless Steel





# DOOR ACCESSORIES

## COAT HOOKS

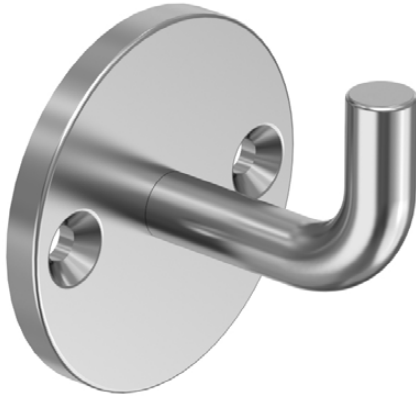

### P152 COAT HOOK W/ ROUND BASE

NO.	PROJECTION	BASE
P152	1.75"	Ø 2"

**FEATURED FINISHES:** Flat Black (19), Satin Stainless (32D)

**FINISHES:** Standard & Custom Available (See Pages 16 & 17)

**MATERIALS:** Brass, Bronze, Stainless Steel



### P154 STRIP COAT HOOK

NO.	PROJECTION	HEIGHT
P154	2.25"	6"

**FEATURED FINISHES:** Flat Black (19), Satin Aluminum (28)

**FINISHES:** Standard & Custom Available (See Pages 16 & 17)

**MATERIAL:** Aluminum

**PRODUCT OPTIONS:** Up to 10 Hooks Per Strip



# DOOR ACCESSORIES

## COAT HOOKS

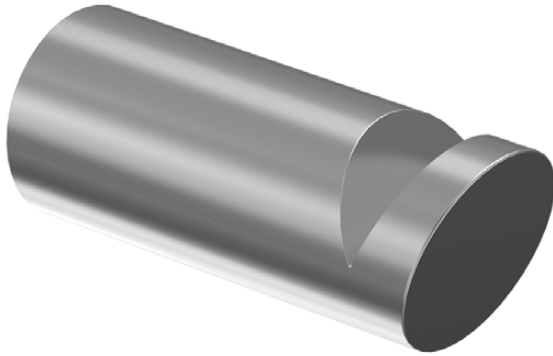

### P159

#### LONG COAT HOOK KNOB W/ NOTCH

NO.	PROJECTION	DIAMETER
P159	2.5"	Ø 1"

**FEATURED FINISHES:** Flat Black (19), Satin Chrome (26D)

**FINISHES:** Standard & Custom Available (See Pages 16 & 17)

**MATERIALS:** Aluminum, Brass, Bronze

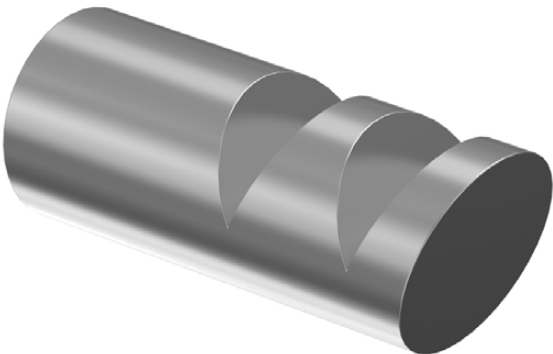

### P160

#### LONG COAT HOOK KNOB W/ DOUBLE NOTCH

NO.	PROJECTION	DIAMETER
P160	2.5"	Ø 1"

**FEATURED FINISHES:** Flat Black (19), Satin Chrome (26D)

**FINISHES:** Standard & Custom Available (See Pages 16 & 17)

**MATERIALS:** Aluminum, Brass, Bronze



# DOOR ACCESSORIES

## COAT HOOKS

---



**P164**  
**COAT HOOK KNOB W/ ROUNDED NOTCH**

<b>NO.</b>	<b>PROJECTION</b>	<b>DIAMETER</b>
<b>P164</b>	1.5"	Ø 1"

**FEATURED FINISHES:** Flat Black (19), Satin Chrome (26D)

**FINISHES:** Standard & Custom Available (See Pages 16 & 17)

**MATERIALS:** Aluminum, Brass, Bronze



# HANDRAILS & BRACKETS

---



**238** HANDRAILS

**240** HANDRAIL BRACKETS





# HANDRAILS & BRACKETS

## HAND RAILS

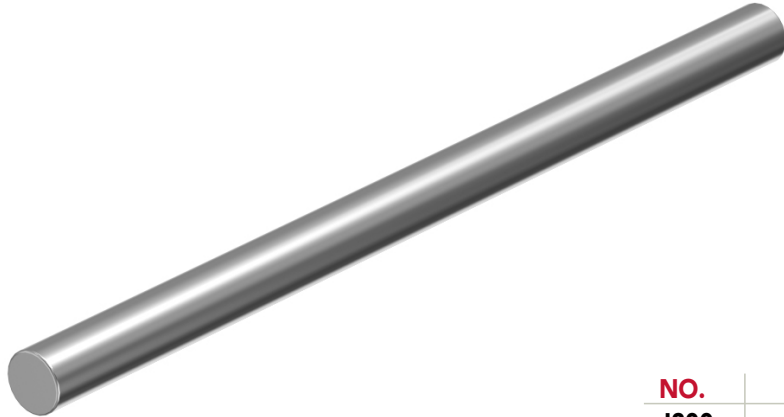

### J200 ROUND HAND RAIL

NO.	MATERIAL	LENGTH
J200	Ø 1.5"	UP TO 96"

**FEATURED FINISHES:** Flat Black (19), Satin Stainless (32D), Antimicrobial (AM)

**FINISHES:** Standard & Custom Available (See Pages 16 & 17)

**MATERIALS:** Brass, Bronze, Stainless Steel

**NOTES:** Straight Sections Only • Up To 96" Long

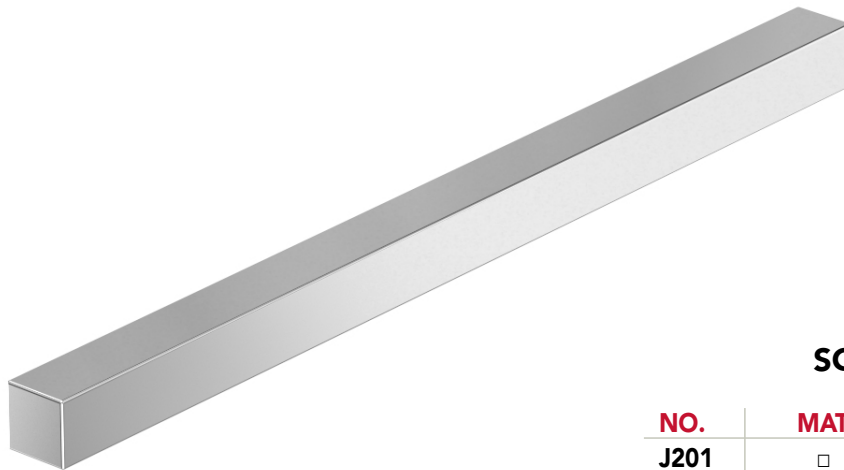

### J201 SQUARE HAND RAIL

NO.	MATERIAL	LENGTH
J201	□ 1.5"	UP TO 96"

**FEATURED FINISHES:** Flat Black (19), Satin Stainless (32D), Antimicrobial (AM)

**FINISHES:** Standard & Custom Available (See Pages 16 & 17)

**MATERIALS:** Brass, Bronze, Stainless Steel

**NOTES:** Straight Sections Only • Up To 96" Long



# HANDRAILS & BRACKETS

## HAND RAILS

---

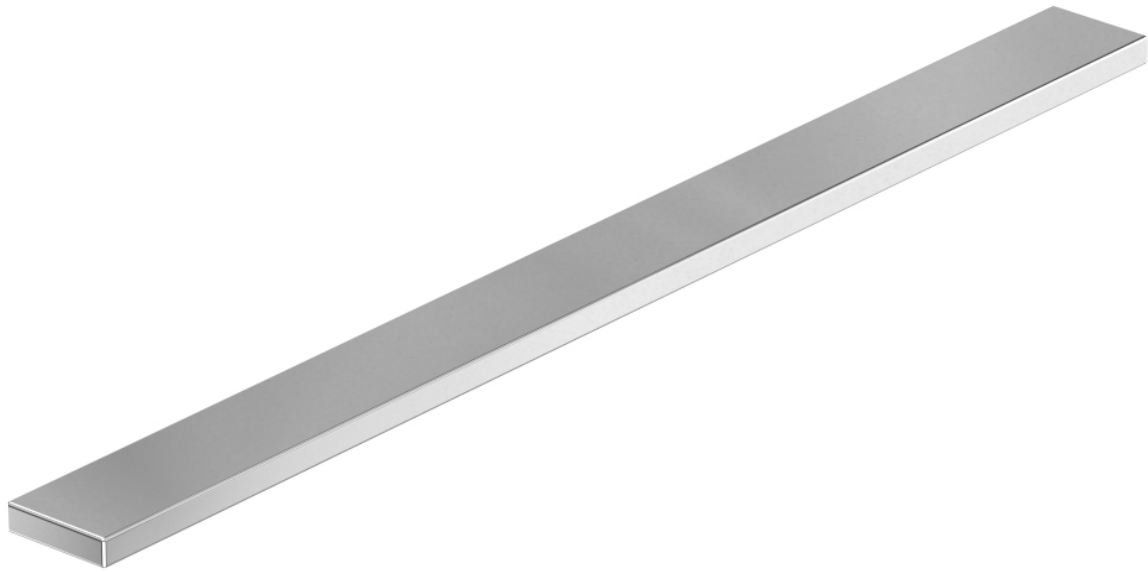

### J202 FLAT HAND RAIL

NO.	MATERIAL	LENGTH
J202	SPECIFY	UP TO 96"

**FEATURED FINISHES:** Flat Black (19), Satin Stainless (32D),  
Antimicrobial (AM)

**FINISHES:** Standard & Custom Available (See Pages 16 & 17)

**MATERIALS:** Brass, Bronze, Stainless Steel

**NOTES:** Straight Sections Only • Up To 96" Long



# HANDRAILS & BRACKETS

## HAND RAIL BRACKETS



### J190

#### HAND RAIL BRACKET W/ CONCEALED MTG

NO.	PROJECTION	BASE
J190	3"	Ø 2"

**FEATURED FINISHES:** Flat Black (19), Satin Chrome (26D)  
**FINISHES:** Standard & Custom Available (See Pages 16 & 17)  
**MATERIALS:** Cast Aluminum, Brass, Bronze

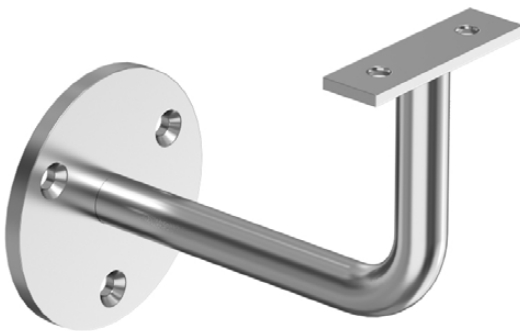

### J191

#### MODERN HAND RAIL BRACKET FOR FLAT BAR

NO.	PROJECTION	BASE
J191	4.5"	Ø 2.5"

**FEATURED FINISHES:** Flat Black (19), Satin Stainless (32D)  
**FINISHES:** Standard & Custom Available (See Pages 16 & 17)  
**MATERIAL:** Solid Stainless Steel



### J192

#### HAND RAIL BRACKET W/ SCREW MTG

NO.	PROJECTION	BASE
J192	3.375"	Ø 3"

**FEATURED FINISHES:** Flat Black (19), Satin Chrome (26D)  
**FINISHES:** Standard & Custom Available (See Pages 16 & 17)  
**MATERIALS:** Cast Aluminum, Brass, Bronze  
**NOTES:** Surface Mounting





# HANDRAILS & BRACKETS

## HAND RAIL BRACKETS



### J193

#### HAND RAIL BRACKET W/ BOLT MTG

NO.	PROJECTION	BASE
J193	3.375"	Ø 3"

**FEATURED FINISHES:** Flat Black (19), Satin Chrome (26D)

**FINISHES:** Standard & Custom Available (See Pages 16 & 17)

**MATERIALS:** Cast Aluminum, Brass, Bronze

**NOTES:** Heavy duty wood screw mounting



### J195

#### MODERN HAND RAIL BRACKET FOR ROUND BAR

NO.	PROJECTION	BASE
P195	3"	Ø 2.125"

**FEATURED FINISHES:** Flat Black (19), Satin Chrome (26D)

**FINISHES:** Standard & Custom Available (See Pages 16 & 17)

**MATERIAL:** Solid Stainless Steel



# STRIKES & FILLER PLATES

---



**244** STRIKES

**251** FLOOR STRIKES

**248** FILLER PLATES





# STRIKES & FILLER PLATES

## STRIKES

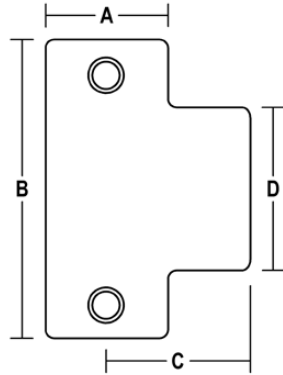

### T45 T-STRIKE BLANK

NO.	A	B	C	D
T45	1.125"	2.75"	1.1875"	1.5"

**FEATURED FINISHES:** Satin Chrome (26D)

**FINISHES:** Standard & Custom Available (See Pages 16 & 17)

**MATERIALS:** Brass, Stainless Steel, Steel

**NOTES:** Custom Sizes Available

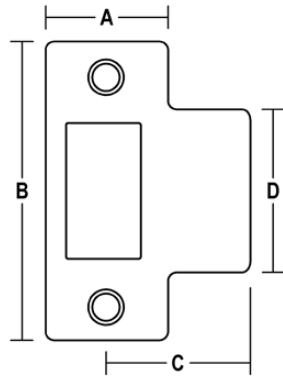

### T46 T-STRIKE

NO.	A	B	C	D
T46	1.125"	2.75"	1.1875"	1.5"

**FEATURED FINISHES:** Satin Chrome (26D)

**FINISHES:** Standard & Custom Available (See Pages 16 & 17)

**MATERIALS:** Brass, Stainless Steel, Steel

**NOTES:** Cut For Lock • Custom Sizes Available

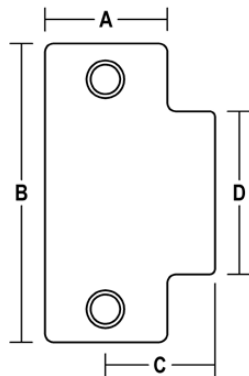

### T47 T-STRIKE BLANK - SHORT LIP

NO.	A	B	C	D
T47	1.125"	2.75"	1"	1.5"

**FEATURED FINISHES:** Paint (PT), Satin Chrome (26D)

**FINISHES:** Standard & Custom Available (See Pages 16 & 17)

**MATERIALS:** Brass, Stainless Steel, Steel

**NOTES:** Custom Sizes Available



# STRIKES & FILLER PLATES

## STRIKES

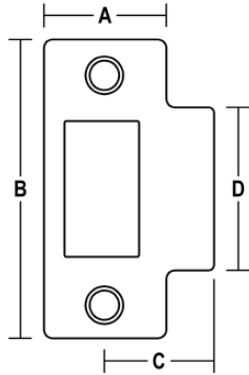

### T48 T-STRIKE - SHORT LIP

NO.	A	B	C	D
T48	1.125"	2.75"	1"	1.5"

**FEATURED FINISHES:** Satin Chrome (26D)

**FINISHES:** Standard & Custom Available (See Pages 16 & 17)

**MATERIALS:** Brass, Stainless Steel, Steel

**NOTES:** Cut For Lock • Custom Sizes Available

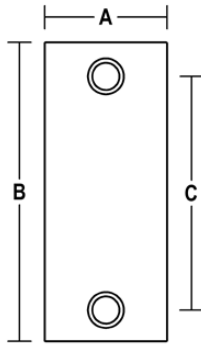

### T49 T-STRIKE BLANK - NO LIP

NO.	A	B	C
T49	1.125"	2.75"	2.125"

**FEATURED FINISHES:** Paint (PT), Satin Chrome (26D)

**FINISHES:** Standard & Custom Available (See Pages 16 & 17)

**MATERIALS:** Brass, Stainless Steel, Steel

**NOTES:** Custom Sizes Available

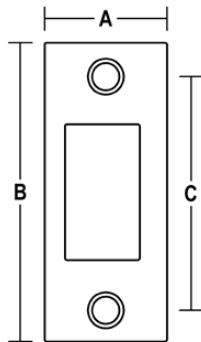

### T50 T-STRIKE - NO LIP

NO.	A	B	C
T50	1.125"	2.75"	2.125"

**FEATURED FINISHES:** Satin Chrome (26D)

**FINISHES:** Standard & Custom Available (See Pages 16 & 17)

**MATERIALS:** Brass, Stainless Steel, Steel

**NOTES:** Cut For Lock • Custom Sizes Available



# STRIKES & FILLER PLATES

## STRIKES

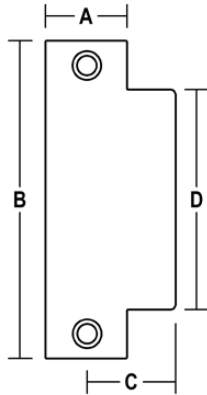

### T51 ASA STRIKE BLANK

NO.	A	B	C	D
T51	1.25"	4.875"	1.25"	3.375"

**FEATURED FINISHES:** Paint (PT), Satin Chrome (26D)

**FINISHES:** Standard & Custom Available (See Pages 16 & 17)

**MATERIALS:** Brass, Stainless Steel, Steel

**NOTES:** Custom Sizes Available

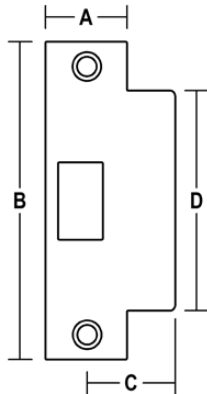

### T52 ASA STRIKE

NO.	A	B	C	D
T52	1.25"	4.875"	1.25"	3.375"

**FEATURED FINISHES:** Satin Chrome (26D)

**FINISHES:** Standard & Custom Available (See Pages 16 & 17)

**MATERIALS:** Brass, Stainless Steel, Steel

**NOTES:** Cut For Lock • Custom Sizes Available

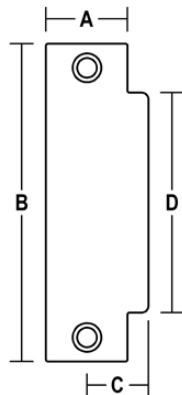

### T53 ASA STRIKE BLANK - SHORT LIP

NO.	A	B	C	D
T53	1.25"	4.875"	1"	3.375"

**FEATURED FINISHES:** Paint (PT), Satin Chrome (26D)

**FINISHES:** Standard & Custom Available (See Pages 16 & 17)

**MATERIALS:** Brass, Stainless Steel, Steel

**NOTES:** Custom Sizes Available



# STRIKES & FILLER PLATES

## STRIKES

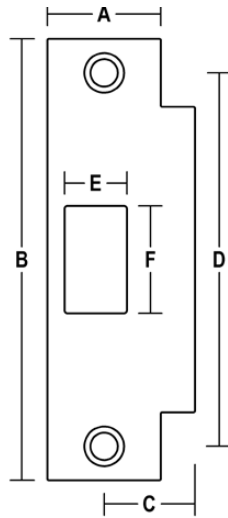

### T54 ASA STRIKE - SHORT LIP

NO.	A	B	C	D
T54	1.25"	4.875"	1"	3.375"

**FEATURED FINISHES:** Satin Chrome (26D)

**FINISHES:** Standard & Custom Available (See Pages 16 & 17)

**MATERIALS:** Brass, Stainless Steel, Steel

**NOTES:** Cut For Lock • Custom Sizes Available

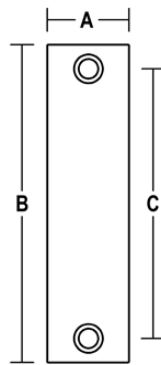

### T55 ASA STRIKE BLANK - NO LIP

NO.	A	B	C
T55	1.25"	4.875"	4.125"

**FEATURED FINISHES:** Paint (PT), Satin Chrome (26D)

**FINISHES:** Standard & Custom Available (See Pages 16 & 17)

**MATERIALS:** Brass, Stainless Steel, Steel

**NOTES:** Custom Sizes Available

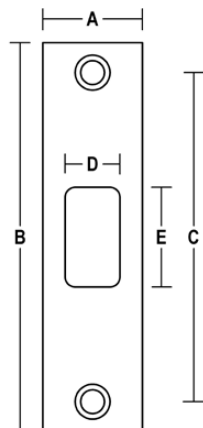

### T56 ASA STRIKE - NO LIP

NO.	A	B	C	D	E
T56	1.25"	4.875"	4.125"	0.6875"	1.25"

**FEATURED FINISHES:** Satin Chrome (26D)

**FINISHES:** Standard & Custom Available (See Pages 16 & 17)

**MATERIALS:** Brass, Stainless Steel, Steel

**NOTES:** Cut For Lock • Custom Sizes Available



# STRIKES & FILLER PLATES

## FILLER PLATES



### T57 FLUSH BOLT FILLER PLATE

NO.	A	B
T57	1"	6.75"

**FEATURED FINISHES:** Paint (PT), Satin Chrome (26D)

**FINISHES:** Standard & Custom Available (See Pages 16 & 17)

**MATERIALS:** Brass, Stainless Steel, Steel

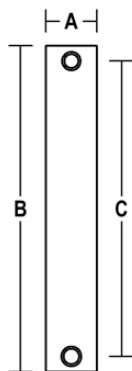

### T58 LOCK FACE FILLER PLATE

NO.	A	B	C
T58	1.25"	8"	7.25"

**FEATURED FINISHES:** Paint (PT), Satin Chrome (26D)

**FINISHES:** Standard & Custom Available (See Pages 16 & 17)

**MATERIALS:** Brass, Stainless Steel, Steel





# STRIKES & FILLER PLATES

## FILLER PLATES

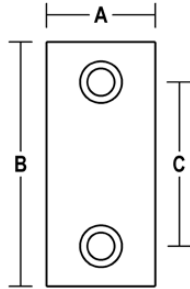

### T59 1" LATCH FILLER PLATE

NO.	A	B	C
T59	1"	2.25"	1.5"

**FEATURED FINISHES:** Paint (PT), Satin Chrome (26D)  
**FINISHES:** Standard & Custom Available (See Pages 16 & 17)  
**MATERIALS:** Brass, Stainless Steel, Steel

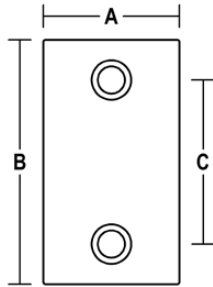

### T60 1-1/8" LATCH FILLER PLATE

NO.	A	B	C
T60	1.125"	2.25"	1.5"

**FEATURED FINISHES:** Paint (PT), Satin Chrome (26D)  
**FINISHES:** Standard & Custom Available (See Pages 16 & 17)  
**MATERIALS:** Brass, Stainless Steel, Steel

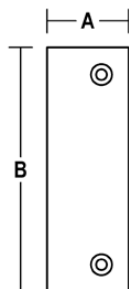

### T61 HINGE FILLER PLATE

NO.	A	B
T61	1.5"	4.5"

**FEATURED FINISHES:** Paint (PT), Satin Chrome (26D)  
**FINISHES:** Standard & Custom Available (See Pages 16 & 17)  
**MATERIALS:** Brass, Stainless Steel, Steel



# STRIKES & FILLER PLATES

## FILLER PLATES

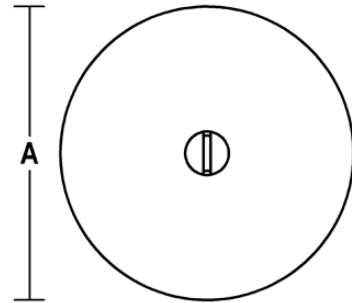
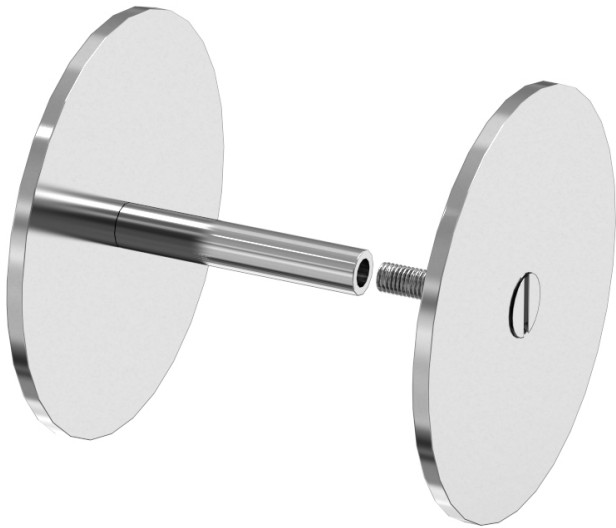

**T62**  
**DEAD BOLT FILLER PLATE**  
**- FOR 1-1/4" HOLE**

NO.	A
T62	Ø 2"

**FEATURED FINISHES:** Paint (PT),  
 Satin Chrome (26D)

**FINISHES:** Standard & Custom Available  
 (See Pages 14 & 15)

**MATERIALS:** Brass, Stainless Steel, Steel

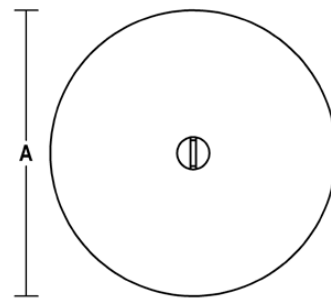

**T63**  
**CUT-OUT FILLER PLATE**  
**- FOR 2-1/8" HOLE**

NO.	A
T63	Ø 2.625"

**FEATURED FINISHES:** Paint (PT), Satin Chrome (26D)

**FINISHES:** Standard & Custom Available (See Pages 16 & 17)

**MATERIALS:** Brass, Stainless Steel, Steel



# STRIKES & FILLER PLATES

## FLOOR STRIKES

---

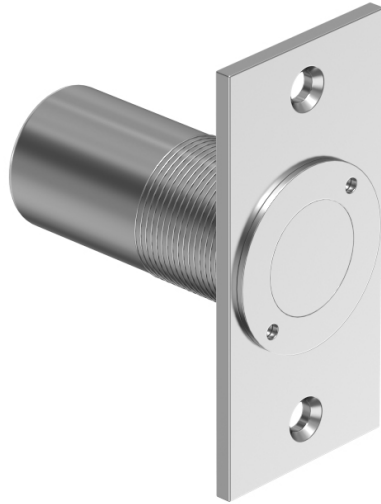

### **F68**

#### **DUST PROOF FLOOR STRIKE**

<b>NO.</b>	<b>FACE</b>	<b>PLATE THICKNESS</b>	<b>STRIKE DEPTH</b>	<b>DIAMETER</b>
<b>F68</b>	1.4" X 2.9"	0.125"	2.25"	0.9375"

**FEATURED FINISHES:** Satin Chrome (26D)

**FINISHES:** Standard & Custom Available (See Pages 16 & 17)



# CABINET PULLS & KNOBS

---





# CABINET PULLS & KNOBS



## M85 WIRE CABINET PULL

NO.	C/C	PROJECTION	DIAMETER
M85A	3"	1.25"	0.3125"
M85B	4"	1.25"	0.3125"
M85C	5"	1.25"	0.3125"
M85D	6"	1.25"	0.3125"

**FEATURED FINISHES:** Flat Black (19), Satin Stainless (32D), Antimicrobial (AM)

**FINISHES:** 10BE, 19, 26D, 32D, PC

**MATERIALS:** Aluminum, Brass, Bronze, Stainless Steel

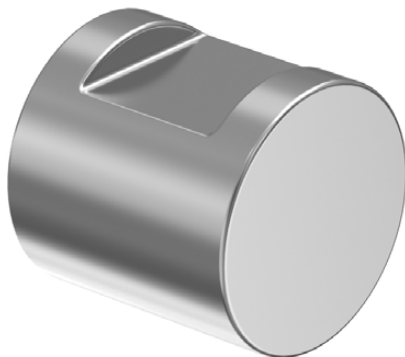

## M93 CABINET KNOB W/ NOTCH

NO.	A
M93A	1" x 1"
M93B	1.25" x 1.25"

**FEATURED FINISHES:** Flat Black (19), Satin Stainless (32D), Antimicrobial (AM)

**FINISHES:** Standard & Custom Available (See Pages 16 & 17)

**MATERIALS:** Aluminum, Brass, Bronze, Stainless Steel



# CABINET PULLS & KNOBS



## **M94** CABINET LADDER PULL

<b>NO.</b>	<b>C/C</b>	<b>OA</b>	<b>DIAMETER</b>
<b>M94</b>	4"	6"	0.5"

**FEATURED FINISHES:** Flat Black (19), Satin Stainless (32D), Antimicrobial (AM)

**FINISHES:** Standard & Custom Available (See Pages 16 & 17)

**MATERIALS:** Aluminum, Brass, Bronze, Stainless Steel

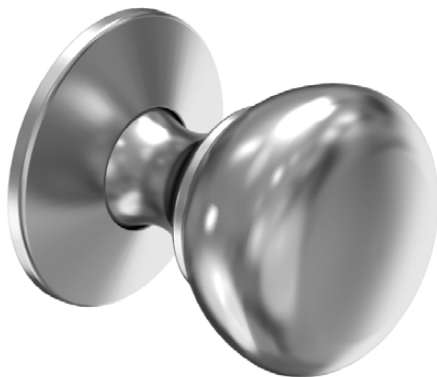

## **M100** CLASSIC CABINET KNOB

<b>NO.</b>	<b>PROJECTION</b>	<b>KNOB DIAMETER</b>	<b>ROSETTE DIAMETER</b>
<b>M100</b>	1.4375"	1.25"	1.3125"

**FEATURED FINISHES:** Flat Black (19), Satin Chrome (26D), Antimicrobial (AM)

**FINISHES:** Standard & Custom Available (See Pages 16 & 17)

**MATERIAL:** Zinc Die Cast





# CLOSET RODS & FLANGES

---

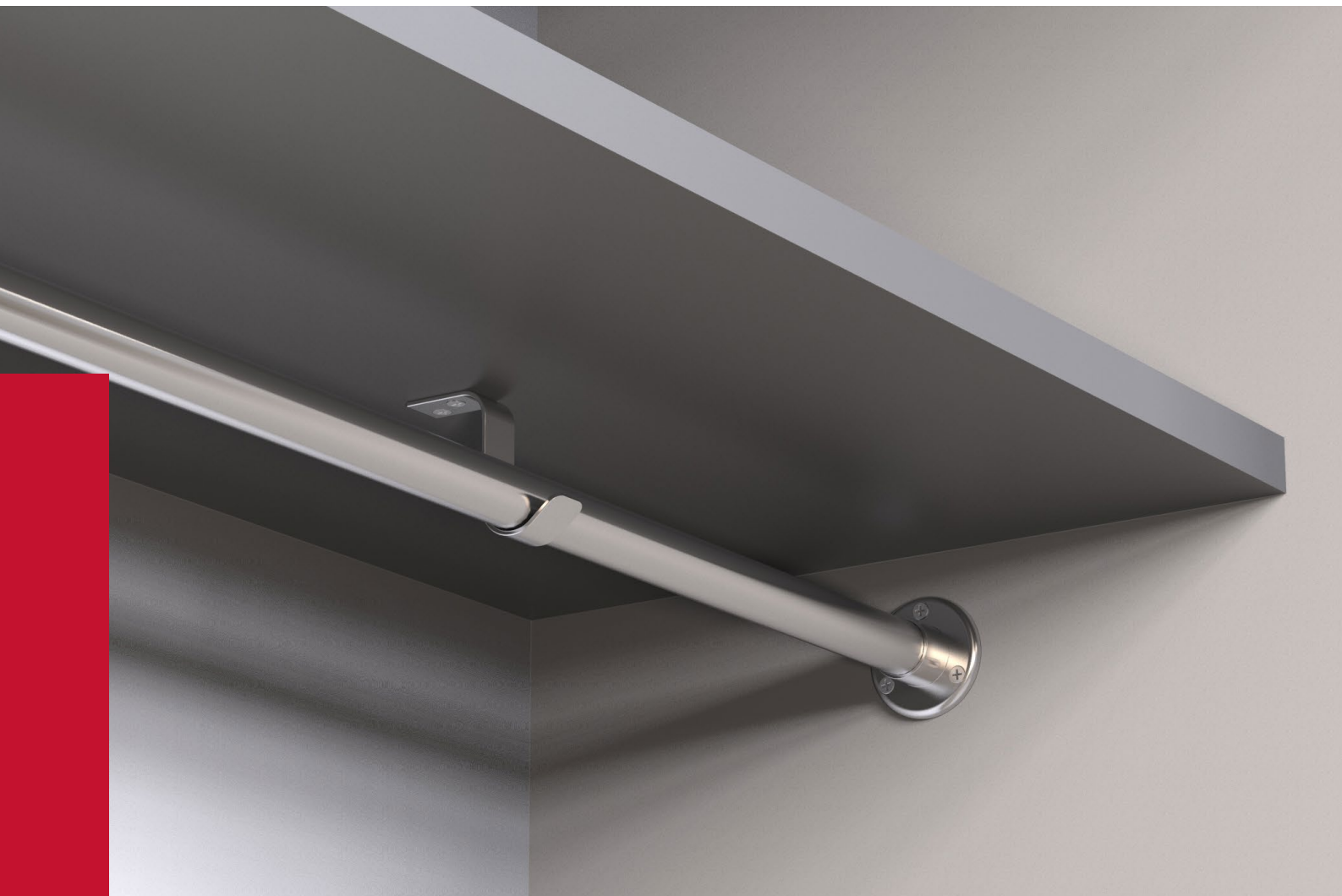



# CLOSET RODS & FLANGES

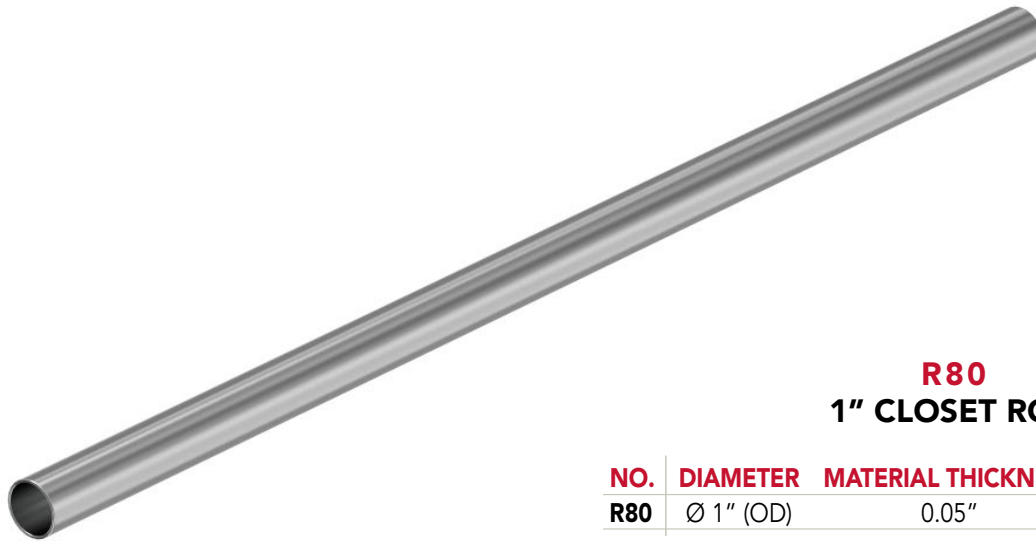

## **R80** **1" CLOSET ROD**

<b>NO.</b>	<b>DIAMETER</b>	<b>MATERIAL THICKNESS</b>	<b>LENGTH</b>
<b>R80</b>	Ø 1" (OD)	0.05"	SPECIFY (96" MAX)

**FEATURED FINISHES:** Flat Black (19), Satin Stainless (32D)

**FINISHES:** Standard & Custom Available (See Pages 16 & 17)

**MATERIALS:** Brass, Stainless Steel, Steel

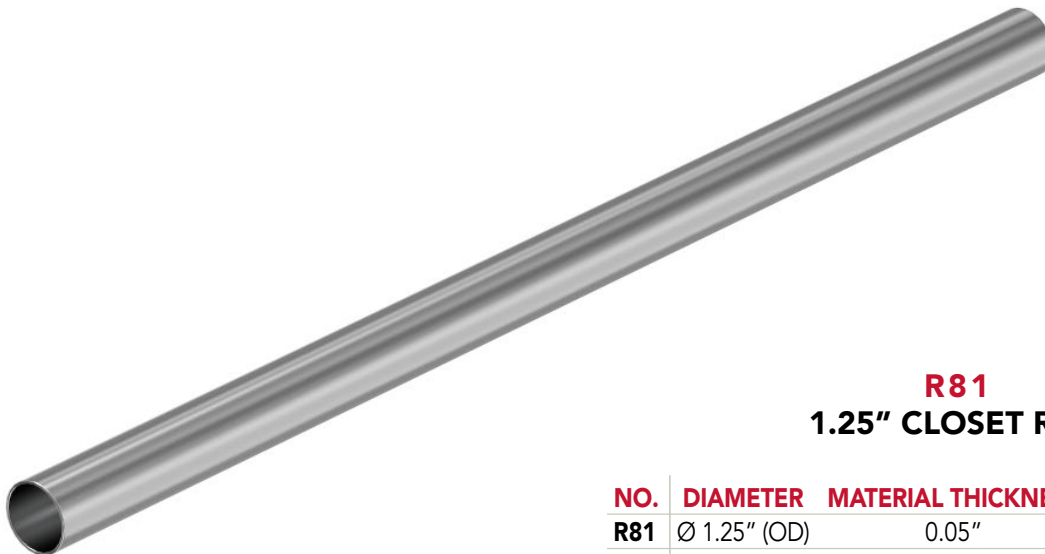

## **R81** **1.25" CLOSET ROD**

<b>NO.</b>	<b>DIAMETER</b>	<b>MATERIAL THICKNESS</b>	<b>LENGTH</b>
<b>R81</b>	Ø 1.25" (OD)	0.05"	SPECIFY (96" MAX)

**FEATURED FINISHES:** Flat Black (19), Satin Stainless (32D)

**FINISHES:** Standard & Custom Available (See Pages 16 & 17)

**MATERIALS:** Brass, Stainless Steel, Steel



# CLOSET RODS & FLANGES



## R82 ROD SUPPORT

NO.	HEIGHT
R82	2.5"

**FEATURED FINISHES:** Flat Black (19), Satin Stainless (32D)

**FINISHES:** Standard & Custom Available (See Pages 16 & 17)

**MATERIAL:** Stainless Steel



## R83 1" CLOSET ROD FLANGE

NO.	DIAMETER
R83	Ø 1" ID

**FEATURED FINISHES:** Flat Black (19), Satin Chrome (26D)

**FINISHES:** Standard & Custom Available (See Pages 16 & 17)

**MATERIAL:** Zinc Die Cast



## R84 1.25" CLOSET ROD FLANGE

NO.	DIAMETER
R84	Ø 1.25" ID

**FEATURED FINISHES:** Flat Black (19), Satin Chrome (26D)

**FINISHES:** Standard & Custom Available (See Pages 16 & 17)

**MATERIAL:** Zinc Die Cast



# HANDS-FREE HARDWARE

---



**262** ARM PULLS

**264** FOOT PULLS





# HANDS-FREE HARDWARE

## ARM PULLS

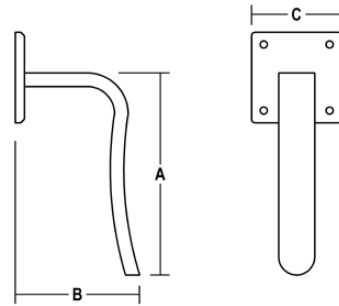

### H417

#### ARM PULL W/ SQUARE BASE

NO.	A	B	C
H417	5.5"	3.5"	□ 2.5"

**FEATURED FINISHES:** Flat Black (19), Satin Stainless (32D), Antimicrobial (AM)

**FINISHES:** Standard & Custom Available (See Pages 16 & 17)

**MATERIALS:** Brass, Bronze, Stainless Steel

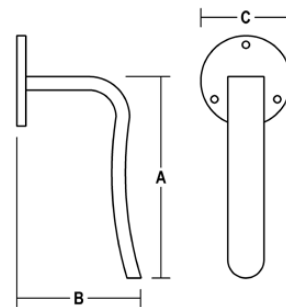

### H418

#### ARM PULL W/ ROUND BASE

NO.	A	B	C
H418	5.5"	3.5"	Ø 2.5"

**FEATURED FINISHES:** Flat Black (19), Satin Stainless (32D), Antimicrobial (AM)

**FINISHES:** Standard & Custom Available (See Pages 16 & 17)

**MATERIALS:** Brass, Bronze, Stainless Steel



# HANDS-FREE HARDWARE

## ARM PULLS

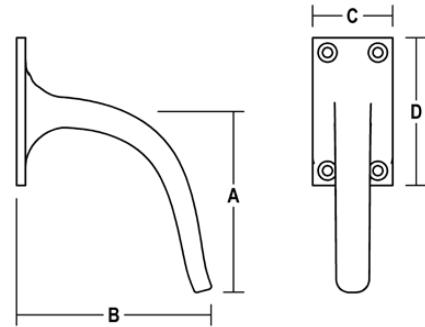

### H419

#### ARM PULL W/ RECTANGULAR BASE

NO.	A	B	C	D
H419	3.625"	4"	1.625"	3"

**FEATURED FINISHES:** Flat Black (19), Satin Chrome (26D), Antimicrobial (AM)

**FINISHES:** Standard & Custom Available (See Pages 16 & 17)

**MATERIAL:** Cast Aluminum, Brass, Bronze

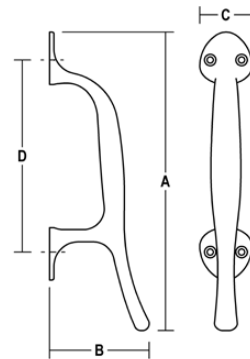

### H420

#### HAND & ARM PULL

NO.	A	B	C	D
H420	9"	3"	1.5"	6"

**FEATURED FINISHES:** Flat Black (19), Satin Chrome (26D), Antimicrobial (AM)

**FINISHES:** Standard & Custom Available (See Pages 16 & 17)

**MATERIALS:** Cast Aluminum, Brass, Bronze



# HANDS-FREE HARDWARE

## FOOT PULLS

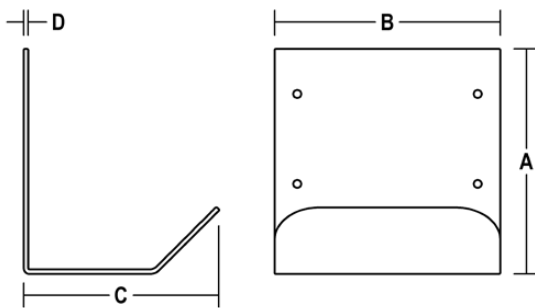
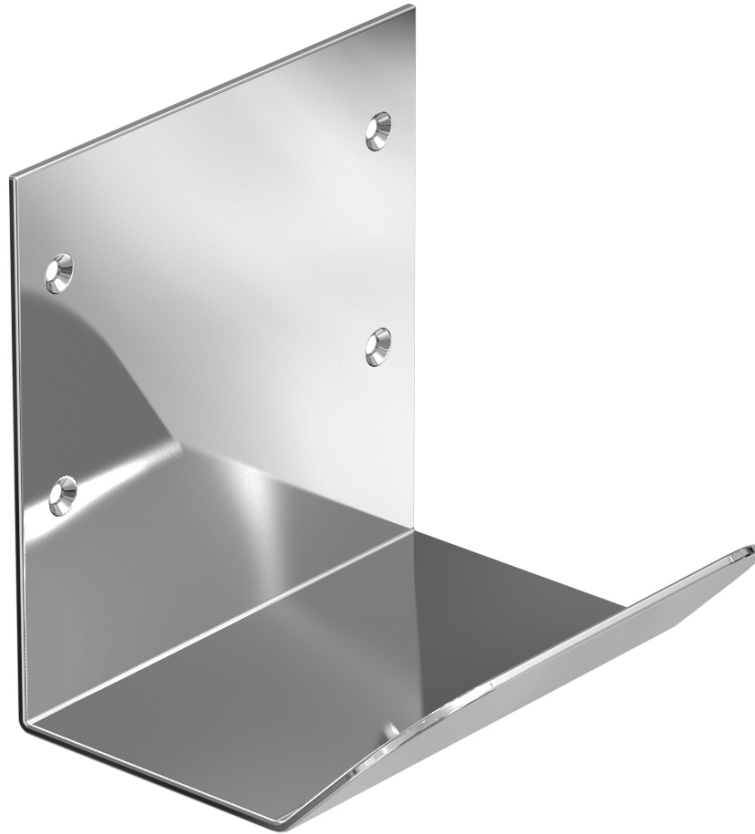

### H435 FOOT PULL

NO.	A	B	C	D
H435	5"	5"	4.375"	0.1"

**FEATURED FINISHES:** Flat Black (19), Satin Stainless (32D), Antimicrobial (AM)

**FINISHES:** Standard & Custom Available (See Pages 16 & 17)

**MATERIAL:** Stainless Steel

**PRODUCT OPTIONS:** Custom Plating Options Available





# HANDS-FREE HARDWARE

## FOOT PULLS

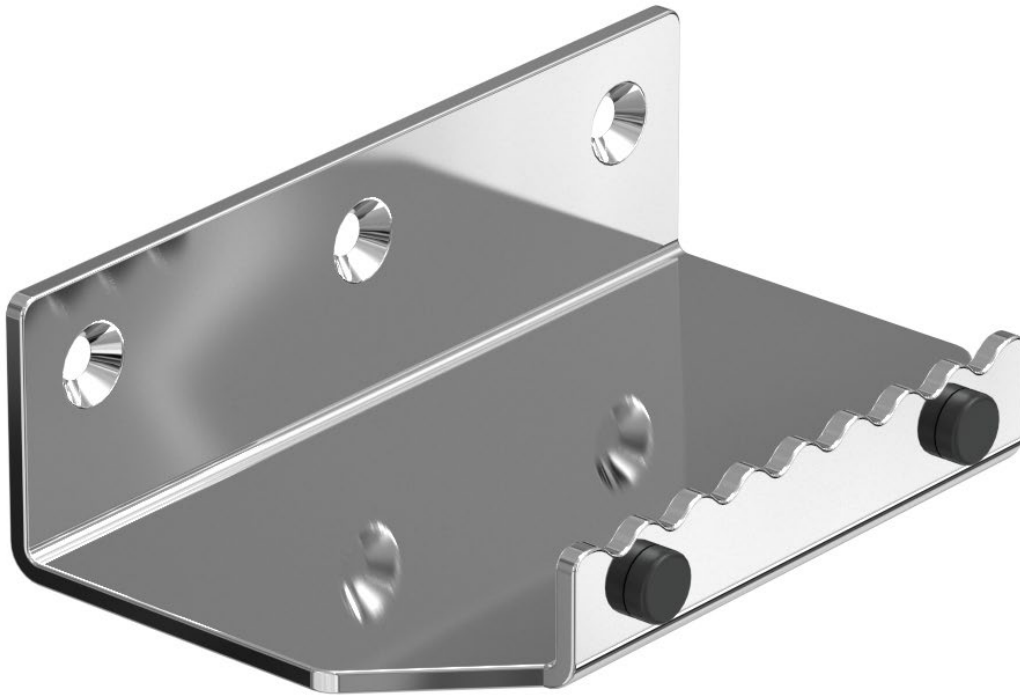

### H444 STEP PULL

NO.	A	B	C	D
	3"	5"	1.5"	0.125"

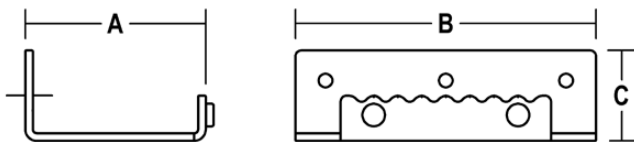

**FEATURED FINISHES:** Flat Black (19), Satin Stainless (32D), Antimicrobial (AM)

**FINISHES:** Standard & Custom Available (See Pages 16 & 17)

**MATERIAL:** Stainless Steel

**PRODUCT OPTIONS:** Custom Plating Options Available



# INDEX

## 2000

2000	22
2100	22
2200	23
2300	23
2400	24
2500	24

## 3000

3000	26
3100	26
3200	27
3300	27
3400	28
3500	28

## 6000

6000	39
6100	39
6200	40
6300	40
6400	41
6500	41

## 9000

9000	30
9100	30
9200	31
9300	31
9400	32
9500	32

## B

B301	43
B302	43
B303	43
B304	44
B305	44
B309	45
B310	45
B311	46

B312	46
B313	47
B314	47
B315	48
B317	49
B318	174
B319	174
B320	174
B321	175
B322	175
B323	176
B324	176
B325	177
B326	177

## C

C320	34
C321	34
C322	34
C323	35
C327	35
C340	35

## D

D351	52
D352	53
D354	53
D355	62
D356	57
D358	62
D359	57
D360	63
D361	63
D362	100
D363	100
D364	101
D365	95
D367	64
D368	64
D369	65
D370	58

D373	101
D374	102
D376	67
D377	104
D378	58
D379	112
D380	67
D381	68
D382	68
D383	69
D384	74
D386	74
D387	75
D388	69
D392	108
D396	70
D397	70
D398	116
D400	114
D401	76
D402	71
D403	65
D405	113
D406	112
D410	113
D413	95
D418	114
D422	93
D432	76
D433	115
D434	77
D436	115
D439	59
D452	54
D453	55
D454	54
D455	55
D460	52
D500	92
D502	104
D503	116



# INDEX

D506	117	D612	83	F7940/FB	213
D508	109	D613	83	F7960/FB	214
D509	109	D614	84	F7942	211
D511	59	D615	85	F7945	217
D512	94	D620	86	F7962	214
D514	96	D621	86	F7970/FB	215
D515	66	D622	87	F7975	215
D516	98	D623	87	F80	226
D517	98	D624	98	F89	227
D520	60	D625	98	F90	227
D521	107	D630	89	F92	228
D522	60	D631	89	F93	228
D523	75	D632	90	FANTOM-DS	206
D524	117	D633	90	FANTOM-F	207
D525	99	D634	91	FB	218
D526	71	D635	91	FILLBAR	221
D527	72	D640	56		
D531	93	D641	56	<b>G</b>	
D533	96			G200-70-P	180
D534	97	<b>F</b>		G214-70-P	180
D538	66	F500	219	G218-70-P	181
D541	77	F64UL	210	G219-70-P	181
D543	61	F65UL	210	G220-70-P	182
D545	105	F67UL	222	G227-P	185
D562	106	F68	251	G240	183
D567	110	F69	223	G241	184
D568	110	F70	223	G300-70-P	186
D572	103	F75	224	G314-70-P	186
D579	61	F76	224	G318-70-P	187
D581	111	F77	225	G319-70-P	188
D582	111	F78	225	G320-70-P	189
D591	94	F7600	220		
D595	73	F7600-NX	220	<b>H</b>	
D600	78	F7601AB	221	H400	136
D601	78	F7601C	221	H401	136
D602	79	F7805/FB	212	H402	137
D603	79	F7840/FB	212	H403	137
D604	80	F7842	211	H404	137
D605	81	F7845	216	H406	138
D610	82	F79	226	H407	141
D611	82	F7905/FB	213	H408	141



# INDEX

H409	141	K15	158	P149	232
H410	142	K16	158	P152	233
H411	142	K17	159	P154	233
H412	143	K22	159	P159	234
H413	144	K28	168	P160	234
H414	144	K29	168	P164	235
H415	145	K30	154		
H416	145	K31	155	<b>R</b>	
H417	36/262	K32	152	R80	258
H418	36/262	K33	153	R81	258
H419	37/263	K34	153	R82	259
H420	37/263	K35	169	R83	259
H421	38	K36	169	R84	259
H426	146	K37	164		
H428	138	K38	164	<b>S</b>	
H429	139	K39	165	S100	192
H435	147/264	K40	165	S101	192
H444	147/265	K41	166	S102	192
H462	140	K42	166	S102L	193
H472	140	K43	167	S102LF	193
H485	139	K44	167	S103	193
		K50	172	S104	194
<b>J</b>		K51	173	S105	194
J190	240	K60	171	S107	195
J191	240	K61	170	S109	195
J192	240	K62	170	S110	195
J193	241			S111	203
J195	241	<b>M</b>		S112	203
J200	238	M85	254	S113	196
J201	238	M93	254	S114	196
J202	239	M94	255	S115	196
		M100	255	S116	197
<b>K</b>				S117	197
K08	150	<b>P</b>		S118	198
K09	150	P140	229	S119	199
K10	151	P141	229	S120	199
K10R	151	P142	230	S121	199
K11	156	P143	230	S122	200
K12	156	P146	231	S123	200
K13	157	P147	231	S128	201
K14	157	P148	232	S147	201



# INDEX

---

<b>S129</b> .....	202	<b>T54</b> .....	247
<b>S130</b> .....	202	<b>T55</b> .....	247
<b>S131</b> .....	202	<b>T56</b> .....	247
<b>S142</b> .....	198	<b>T57</b> .....	248
<b>SMPL3302</b> .....	120	<b>T58</b> .....	248
<b>SMPL3303</b> .....	120	<b>T59</b> .....	249
<b>SMPL3304</b> .....	121	<b>T60</b> .....	249
<b>SMPL3305</b> .....	121	<b>T61</b> .....	249
<b>SMPL3306</b> .....	122	<b>T62</b> .....	250
<b>SMPL3307</b> .....	123	<b>T63</b> .....	251
<b>SMPL313-XS4ONE</b> .....	128		
<b>SMPL510-L9000</b> .....	126		
<b>SMPL510-8200</b> .....	126		
<b>SMPL510-8800</b> .....	126		
<b>SMPL510-NM8070</b> .....	127		
<b>SMPL510-ML2000</b> .....	127		
<b>SMPL510-M1</b> .....	127		
<b>SMPL510-XS4MINI</b> .....	128		
<b>SMPL513-XS4</b> .....	129		
<b>SMPL514-AE</b> .....	129		
<b>SMPL510-HES1500-ES</b> .....	130		
<b>SMPL510-HES1600-ES</b> .....	130		
<b>SMPL510-HES1006-ES</b> .....	130		
<b>SMPL510-GK1300-ES</b> .....	131		
<b>SMPL510-L6514-ES</b> .....	131		
<b>SMPL510-6400-ES</b> .....	131		
<b>SMPL-UCH48</b> .....	132		
<b>SMPL-UCH60</b> .....	132		
<b>SMPL830-LS</b> .....	133		
<b>SMPL830-SS</b> .....	133		
<b>T</b>			
<b>T45</b> .....	244		
<b>T46</b> .....	244		
<b>T47</b> .....	244		
<b>T48</b> .....	245		
<b>T49</b> .....	245		
<b>T50</b> .....	245		
<b>T51</b> .....	246		
<b>T52</b> .....	26		
<b>T53</b> .....	246		



# NOTES

---



# NOTES

---



© STANDARD METAL HARDWARE MANUFACTURING INC. 2022  
29 Rangemore Road, Toronto, Ontario, Canada M8Z 5H8  
**Tel:** 416-744-1510 **Fax:** 416-744-3338 **Toll Free:** 1-800-267-5442  
**Web:** [www.smhardware.com](http://www.smhardware.com) **Email:** [sales@smhardware.com](mailto:sales@smhardware.com)