



CROWDTRACK

QUALITY SLIDING DOOR HARDWARE



October 2019 v.3



CATCH 'N' CLOSE[®]
Closes safely and silently

Family owned and operated
for over 70 years
kncrowder.com



What makes **CROWDERTRACK** better?



K.N.CROWDER

is committed to providing the sliding door industry with quality engineered, durable, time-tested door hardware. Crowdertrack was formed in the late 1940s. Since that time we have had the pleasure of supplying quality sliding door hardware to the construction industry.

Help and cooperation from architectural hardware consultants, lumber dealers, wholesale and retail hardware houses has been paramount to our continued growth and success.

We wish to acknowledge this support and express sincere thanks to all our many friends and valued customers for this continuing support.



"This catalogue represents a proud body of engineering work serving the sliding and folding door hardware industry. Our engineering experts are always more than happy to discuss your specific hardware needs. Commitment to our customers' continued satisfaction is our primary goal."

Peter Crowder
President,
K.N. Crowder Mfg. Inc.



How to Specify CROWDERTRACK

To assist us in understanding your specific needs and processing your order flawlessly, there are **three items we need to know**, in addition to the dimensions, about your installation:

- 1 Determine your door type requirements.**
Examples are: single track pocket, front, top or rear mounted, dual track bypassing, 2 single tracks employed as dual bypassing, bi-parting or bi-folding/pivot.
- 2 Estimate or determine the door weight** you will need to accommodate. A reference table below is shown to assist with this calculation.
- 3 Determine your opening size.** Charts of standard sizes and configurations, as well as hardware required are shown on each product page of this catalogue, where applicable. Consider allowances and clearances for recessed pockets where applicable.

If you require alternate configurations or have special track requirements, we would be more than happy to discuss your needs.

Average Door Weight (lbs) for 7ft [2134mm] 1-3/8" [34.9mm] thick

Door Width	Hollow Wood Core	Solid Pine	Hollow Core Steel	Solid Oak
12" [305 mm]	14	21	28	35
18" [457 mm]	21	32	42	53
24" [610 mm]	28	42	56	70
30" [762 mm]	25	53	70	88
36" [914 mm]	42	63	84	105

For 8ft [2438mm] doors, 1-3/8" [34.9mm] thick, multiply by 1.14 for approx. weight

For 7ft [2134mm] doors, 1-3/4" [44.5mm] thick, multiply by 1.25 for approx. weight

For 8ft [2438mm] doors, 1-3/4" [44.5mm] thick, multiply by 1.50 for approx. weight

NOTE: SPECIFICATIONS ARE SUBJECT TO CHANGE WITHOUT NOTICE

PRECISION GROUND Bearings

WE HAVE REDESIGNED our nylon ball bearing wheels & hangers. The new and improved hangers will now be supplied with our new precision ground bearings.

These new precision ground bearings will easily handle the same load capacity (weight) but are virtually silent and incredibly smooth.

We have cycle tested * our new hangers to the equivalent of over 30 years of normal use (over 150,000 cycles) without experiencing any measurable wear or increase in noise.

* One cycle = one opening and one closing of the door



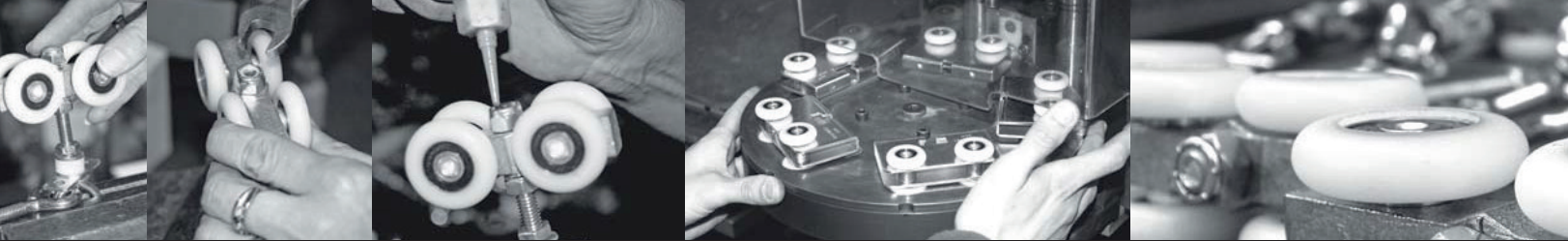

Track Series

Hanger Type

Weight

Page

Exposed Barn Door Systems

CRT-100 Top, Strap & Glass Door Catch 'N' Close Hangers



Up to 350 lbs. per door

11-15

CRT-50 Top, Strap & Glass Door Catch 'N' Close Hangers



Up to 175 lbs. per door

17-21

CFT-200 Top, Strap & Glass Door Catch 'N' Close Hangers



Up to 300 lbs. per door

25-33

J-TRACK 300 Top & Strap Mount Catch 'N' Close Hangers



Up to 200 lbs. per door

34-35

••• Catch 'N' Close Product Information

Up to 300 lbs. per door

23

Glass Systems

CRT-100 Catch 'N' Close Glass Hangers



Up to 350 lbs. per door

15

CRT-50 Catch 'N' Close Glass Hangers



Up to 175 lbs. per door

21

CFT-200 Catch 'N' Close Glass Hangers



Up to 300 lbs. per door

33

••• Catch 'N' Close Glass Hangers



Up to 300 lbs. per door

57

••• Catch 'N' Close Glass Hangers



Up to 300 lbs. per door

59

Ceiling Track Systems

CC-904 & CC-404 Zero Clearance Catch 'N' Close Hangers



Up to 300 lbs. per door

37

CC-904 & CC-404 Easy Connect Catch 'N' Close Hangers

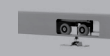

Up to 200 lbs. per door

39

CC-905 Drywall Ceiling Track with Catch 'N' Close



Up to 300 lbs. per door

41

C-104 Zero Clearance Hangers



Up to 300 lbs. per door

87

C-104 Quick Release Hangers



Up to 200 lbs. per door

89

C-104 Heavy-Duty Nylon Wheel Hangers



Up to 450 lbs. per door

91

C-204 Heavy-Duty Steel Wheel Hangers



Up to 700 lbs. per door

93

C-104 Nylon Wheel Hangers



Up to 500 lbs. per door

97

C-411 & C-400 Quick Release & Top Mount Hangers



Up to 150 lbs. per door

99

C-350 Top Mount & Concealed Hangers



Up to 75 lbs. per door

101

Barn Door Systems

CC-904 w/ CC-902 Zero Clearance & Easy Connect Catch 'N' Close Hangers



Up to 300 lbs. per door

43

CC-908 Zero Clearance Catch 'N' Close Hangers



Up to 300 lbs. per door

45

CC-908 Easy Connect Catch 'N' Close Hangers



Up to 200 lbs. per door

47

CC-908 & CC-408 Zero Clearance Catch 'N' Close Hangers



Up to 300 lbs. per door

49

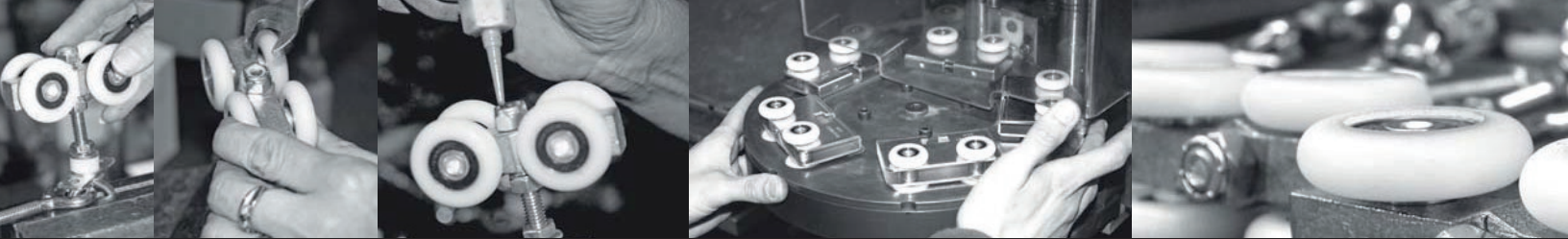





















Track Series

Hanger Type

Weight

Page

	Track Series	Hanger Type		Weight	Page
Barn Door Systems	CC-908 & CC-408	Easy Connect Catch'N'Close Hangers		Up to 200 lbs. per door	51
	C-108	Zero Clearance Hangers		Up to 300 lbs. per door	103
	C-108	Quick Release Hangers		Up to 200 lbs. per door	105
	C-108	Heavy-Duty Nylon Wheel Hangers		Up to 450 lbs. per door	107
	C-108	Nylon Wheel Hangers		Up to 500 lbs. per door	109
Bypass Systems	CC-500	Zero Clearance Catch'N'Close Hangers		Up to 150 lbs. per door	53
	CC-500	Easy Connect Catch'N'Close Hangers		Up to 150 lbs. per door	55
	C-500 & C-538	Top Mount Hangers		Up to 125 lbs. per door	111
	C-600	Top Mount & Concealed Hangers		Up to 75 lbs. per door	113
	C-2035, C-2025	Side Mount Hangers		Up to 60 lbs. per door	115
Crowderframe Pocket Door Systems	•••	Crowderframe Pocket Door Kit - How it all comes together			61
	TYPE CC-HD-2X6	Heavy-Duty Easy Connect Catch'N'Close Hangers		Up to 300 lbs. per door	63
	TYPE CC-2X6 & TYPE CC	Easy Connect Catch'N'Close Hangers		Up to 150 lbs. per door	65
	TYPE C-2X6, TYPE C & TYPE B	Quick Release & Top Mount Hangers		Up to 150 lbs. per door	67
	•••	Extra Wide/High Pocket Door Kits and Bi-Parting Pocket Door Add-on Products			68-69
	TYPE CC	2X4 Snap-on Aluminum Crowderframe Pocket Trim Kits			70-71
	•••	Sound Sealing Pocket Doors			72-73
Custom Systems	CST	Stacking Track Systems		Up to 300 lbs. per door	75
	•••	Come-Along Systems		Up to 350 lbs. per door	77
	•••	Crowderslide Telescoping Door Systems		Varies	79
	•••	Strike & Jamb Kits			81
	•••	Cantilever Door Systems		Varies	83
	•••	High Security Door Systems		Varies	85
	•••	Exterior Applications		Up to 450 lbs. per door	95

	Track Series	Hanger Type		Weight	Page
Crowder Folding Systems	C-975	Center Pivot Hangers		Up to 250 lbs. per door	117
	C-104 & C-204	Easy Connect Pivot Kits		Up to 150 lbs. per door	119
	CF-115 & CF-100	Pivot Kits		Up to 50 lbs. per door	121
	•••	Trackless Pivots		Up to 200 lbs. per door	123
Door Guides	•••	For 1-3/4" Thick Doors or greater		•••	124
	•••	For 1-3/8" Thick Doors or smaller		•••	125

	Lock Series		Page
Door Locks & Pulls	Privacy Lock Sets		127-129
	Security Lock Sets		131
	Passage Sets		133-135
	Bi-Parting Lock & Passage Sets		137
	Barrier Free (ADA Compliant) Lock Sets		139
	Barn Door Lock Sets		141-143
	Self-Latching Lock Sets		145
	Flush Pulls		147
	Edge Pulls		149
	Glass Door Pulls		151
	Door Handle Pulls		153-155
	Colour Chart		156-157

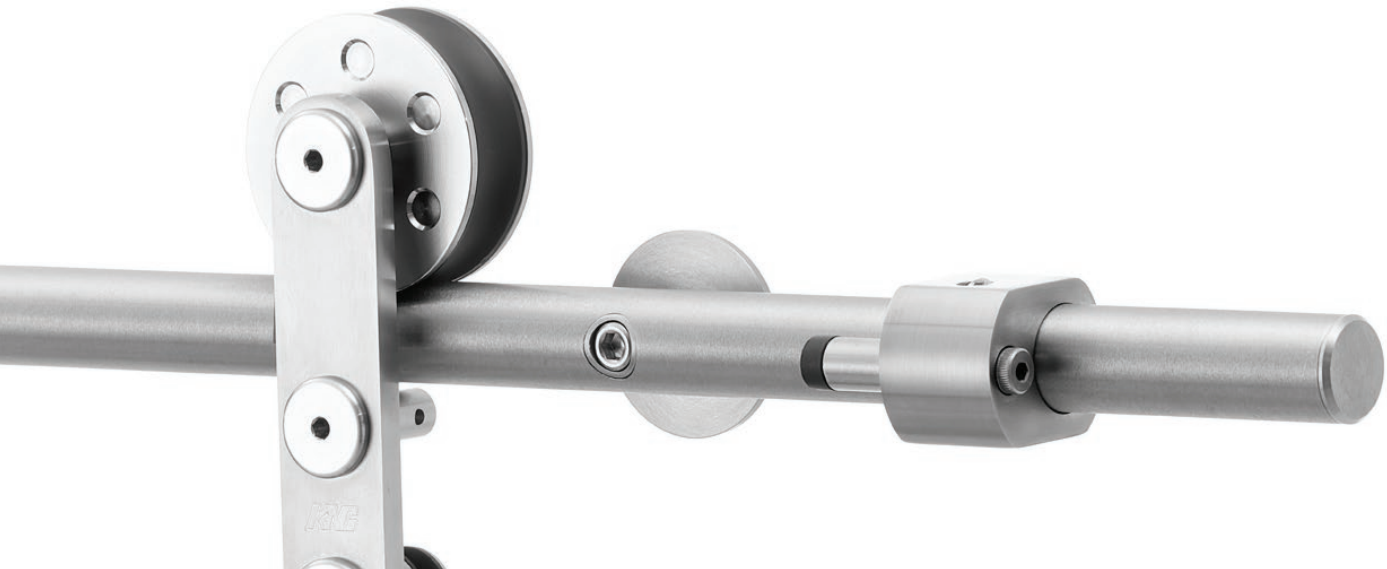

Throw
A CURVE
into your Office
or Home!
SPICE it Up!



KN CROWDER, A LEADER IN THE SLIDING DOOR TRACK INDUSTRY, CAN CURVE ANY TRACK YOU THROW AT THEM!

KNC's curved door track system departs from the traditional and enables interesting spaces to be created using curved walls and doors.

Sliding doors, whether curved or straight, save tremendous amounts of floor space compared to hinged doors. Curved tracks can be side-mounted or top mounted inside a pocket. Almost all tracks and guide channels can be curved to meet the exact specified dimensions. With a 36" [914 mm] minimum, any radius can be accommodated in any arc length. The curved sliding door track system is quiet and durable and ensures that the door's glide is extremely smooth. KN Crowder is committed to innovation. We provide the sliding door industry with quality engineered, durable and time-tested hardware through our Crowdertrack line of sliding door products. Crowdertrack is as 'smooth as flight'.









EXPOSED BARN DOOR SYSTEMS
ARCHITECTURE & DESIGN COLLECTION

CROWDER ROUND TRACK SERIES

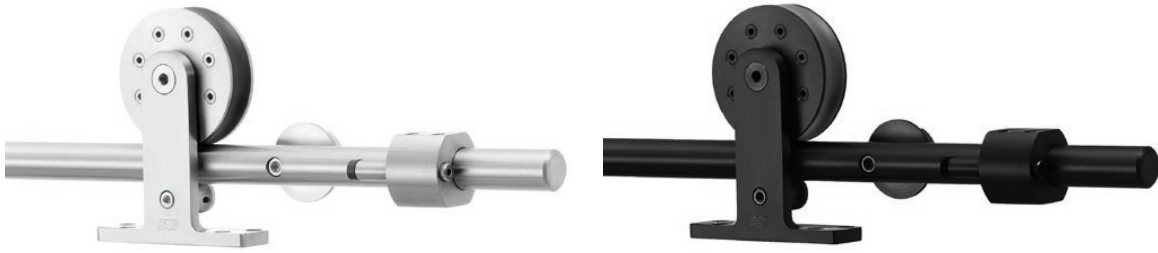

CRT-101-SS & CRT-101-BP
Up to 350 lbs. [159 kg] per door

Crowder Round Track 100 series features our classic top mount hangers for an ultra-modern look.

3-1/2" [88.9mm] Delrin wheels, precision ball bearings and shock absorbing stops come together to provide extremely smooth and quiet door operation. All CRT components are precision-machined 304 stainless steel finished in black or polished to a satin finish.



How to Specify/Order:

Kit Code: CRT-101-SS X [track length] 1DR KIT

Kit Code: CRT-101-BP X [track length] 1DR KIT

Note: [track length] = door width x 2 (for 1 door kits)

Optional Door Handle Pulls:

For 18" [457 mm] back to back handle pulls:

CRT-DP18 x 630 (Stainless Steel)

CRT-DP18 x 622 (Black Finish)

For 36" [914 mm] back to back handle pulls:

CRT-DP36 x 630 (Stainless Steel)

CRT-DP36 x 622 (Black Finish)





EXPOSED BARN DOOR SYSTEMS
ARCHITECTURE & DESIGN COLLECTION

CROWDER ROUND TRACK SERIES

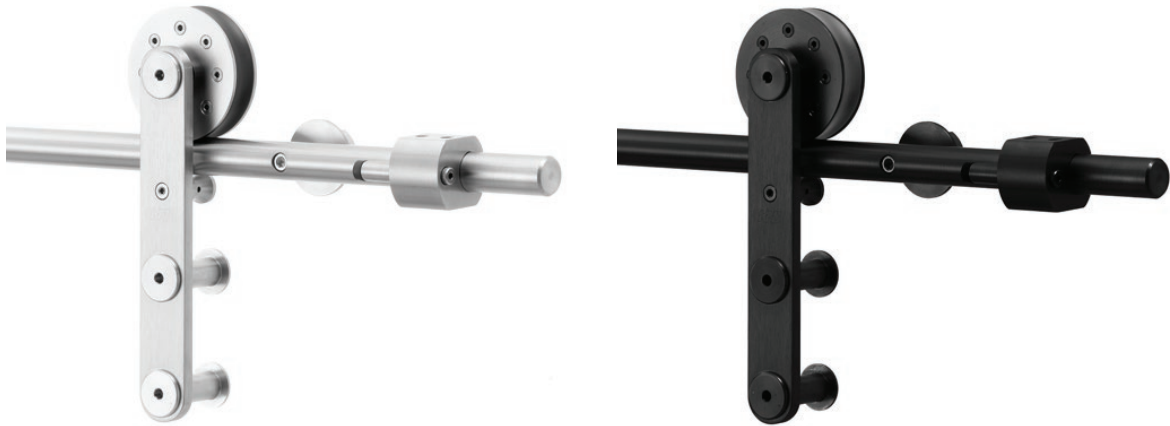

CRT-102-SS & CRT-102-BP
Up to 350 lbs. [159 kg] per door



1-3/4"

Crowder Round Track 100 series features our classic strap mount hangers for an ultra-modern look.

3-1/2" [88.9mm] Delrin wheels, precision ball bearings and shock absorbing stops come together to provide extremely smooth and quiet door operation. All CRT components are precision-machined 304 stainless steel finished in black or polished to a satin finish.



1-3/8"

How to Specify/Order:

Kit Code: CRT-102-SS X [track length] 1DR KIT (For 1-3/4" [44.5 mm] door)

Kit Code: CRT-102-38-SS X [track length] 1DR KIT (For 1-3/8" [34.9 mm] door)

Kit Code: CRT-102-BP X [track length] 1DR KIT (For 1-3/4" [44.5 mm] door)

Kit Code: CRT-102-38-BP X [track length] 1DR KIT (For 1-3/8" [34.9 mm] door)

Note: [track length] = door width x 2 (for 1 door kits)

Optional Door Handle Pulls:

For 18" [457 mm] back to back handle pulls:

CRT-DP18 x 630 (Stainless Steel)

CRT-DP18 x 622 (Black Finish)

For 36" [914 mm] back to back handle pulls:

CRT-DP36 x 630 (Stainless Steel)

CRT-DP36 x 622 (Black Finish)





EXPOSED BARN DOOR SYSTEMS

ARCHITECTURE & DESIGN COLLECTION

CROWDER ROUND TRACK SERIES FOR GLASS DOORS

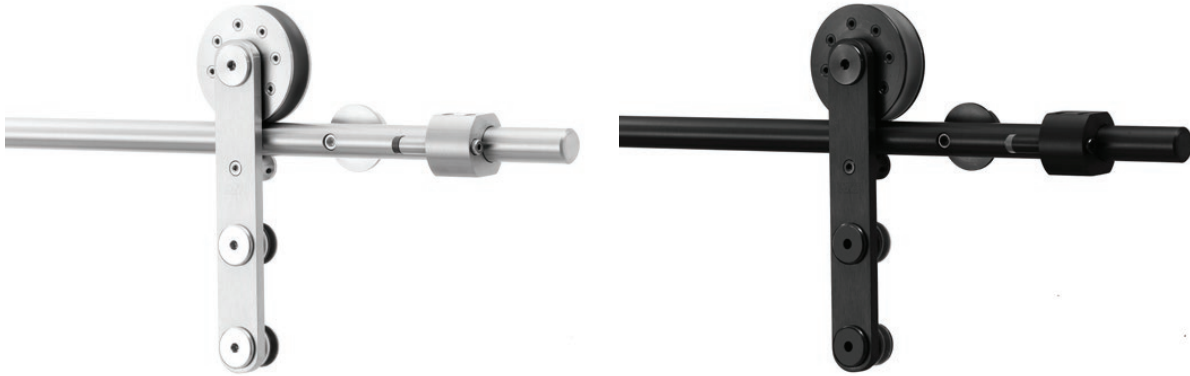

CRT-103-SS & CRT-103-BP
Up to 350 lbs. [159 kg] per door

Crowder Round Track 100 series features our classic strap mount hangers for glass doors.



1/2"

3-1/2" [88.9mm] Delrin wheels, precision ball bearings and shock absorbing stops come together to provide extremely smooth and quiet door operation. All CRT components are precision-machined 304 stainless steel finished in black or polished to a satin finish.



3/8"

How to Specify/Order:

Kit Code: CRT-103-12-SS X [track length] 1DR KIT (for 1/2" [12 mm] Glass)

Kit Code: CRT-103-38-SS X [track length] 1DR KIT (for 3/8" [10 mm] Glass)

Kit Code: CRT-103-12-BP X [track length] 1DR KIT (for 1/2" [12 mm] Glass)

Kit Code: CRT-103-38-BP X [track length] 1DR KIT (for 3/8" [10 mm] Glass)

Note: [track length] = door width x 2 (for 1 door kits)

Optional Glass Door Handle Pulls:

For 18" [457 mm] back to back handle pulls:

CRT-GDP18 x 630 (Stainless Steel)

CRT-GDP18 x 622 (Black finish)

For 36" [914 mm] back to back handle pulls:

CRT-GDP36 x 630 (Stainless Steel)

CRT-GDP36 x 622 (Black finish)





EXPOSED BARN DOOR SYSTEMS
ARCHITECTURE & DESIGN COLLECTION

Coming Soon with Catch'N'Close!

CROWDER ROUND TRACK LIGHT-DUTY SERIES

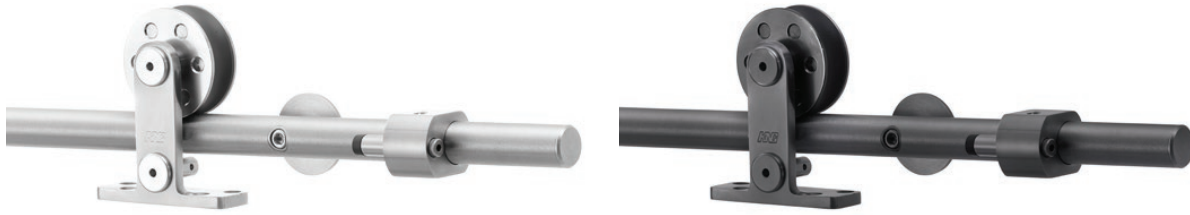

CRT-51-SS & CRT-51-BP
Up to 175 lbs. [79 kg] per door

Crowder Round Track 50 series is the light-duty version of our best-selling CRT-100 series. This hollow tube track system is still able to support up to 175 lbs. [79 kg] per door.

2-3/4" [69.9mm] Delrin wheels, precision ball bearings and shock absorbing stops come together to provide extremely smooth and quiet door operation. All CRT components are precision-machined 303 stainless steel finished in black or polished to a satin finish.



How to Specify/Order:

Kit Code: CRT-51-SS X [track length] 1DR KIT

Kit Code: CRT-51-BP X [track length] 1DR KIT

Note: [track length] = door width x 2 (for 1 door kits)

Optional Door Handle Pulls:

For 18" [457 mm] back to back handle pulls:

CRT-DP18 x 630 (Stainless Steel)

CRT-DP18 x 622 (Black finish)

For 36" [914 mm] back to back handle pulls:

CRT-DP36 x 630 (Stainless Steel)

CRT-DP36 x 622 (Black finish)





EXPOSED BARN DOOR SYSTEMS
ARCHITECTURE & DESIGN COLLECTION

Coming Soon with Catch'N'Close!

CROWDER ROUND TRACK LIGHT-DUTY SERIES

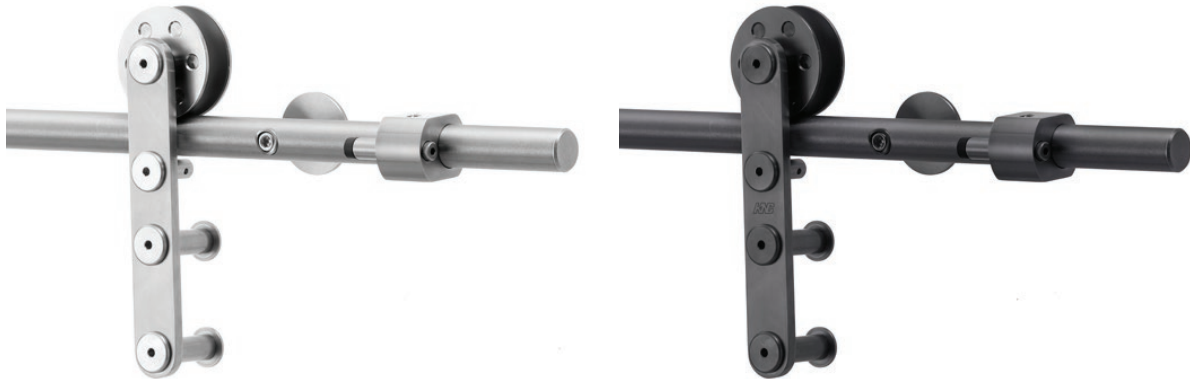

CRT-52-SS & CRT-52-BP
Up to 175 lbs. [79 kg] per door



1-3/4"

Crowder Round Track 50 series is the light-duty version of our best-selling CRT-100 series. This hollow tube track system is still able to support up to 175 lbs. [79 kg] per door. 2-3/4" [69.9mm] Delrin wheels, precision ball bearings and shock absorbing stops come together to provide extremely smooth and quiet door operation. All CRT components are precision-machined 303 stainless steel finished in black or polished to a satin finish.



1-3/8"

How to Specify/Order:

Kit Code: CRT-52-SS X [track length] 1DR KIT (For 1-3/4" [44.5 mm] door)

Kit Code: CRT-52-38-SS X [track length] 1DR KIT (For 1-3/8" [34.9 mm] door)

Kit Code: CRT-52-BP X [track length] 1DR KIT (For 1-3/4" [44.5 mm] door)

Kit Code: CRT-52-38-BP X [track length] 1DR KIT (For 1-3/8" [34.9 mm] door)

Note: [track length] = door width x 2 (for 1 door kits)

Optional Door Handle Pulls:

For 18" [457 mm] back to back handle pulls:

CRT-DP18 x 630 (Stainless Steel)

CRT-DP18 x 622 (Black finish)

For 36" [914 mm] back to back handle pulls:

CRT-DP36 x 630 (Stainless Steel)

CRT-DP36 x 622 (Black finish)





EXPOSED BARN DOOR SYSTEMS
ARCHITECTURE & DESIGN COLLECTION

Coming Soon with Catch'N'Close!

CROWDER ROUND TRACK LIGHT-DUTY SERIES FOR GLASS DOORS

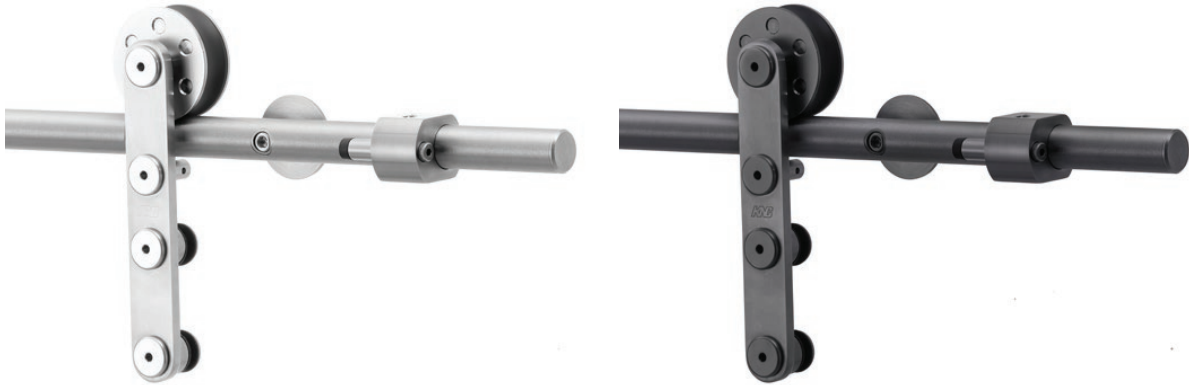

CRT-53-SS & CRT-53-BP
Up to 175 lbs. [79 kg] per door

Crowder Round Track 50 series is the light-duty version of our best-selling CRT-100 series. This hollow tube track system for glass doors is still able to support up to 175 lbs. [79 kg] per door.



2-3/4" [69.9mm] Delrin wheels, precision ball bearings and shock absorbing stops come together to provide extremely smooth and quiet door operation. All CRT components are precision-machined 303 stainless steel finished in black or polished to a satin finish.



How to Specify/Order:

Kit Code: CRT-53-12-SS X [track length] 1DR KIT (for 1/2" [12 mm] Glass & Stainless Steel)

Kit Code: CRT-53-38-SS X [track length] 1DR KIT (for 3/8" [10 mm] Glass & Stainless Steel)

Kit Code: CRT-53-12-BP X [track length] 1DR KIT (for 1/2" [12 mm] Glass & Black Finish)

Kit Code: CRT-53-38-BP X [track length] 1DR KIT (for 3/8" [10 mm] Glass & Black Finish)

Note: [track length] = door width x 2 (for 1 door kits)

Optional Glass Door Handle Pulls:

For 18" [457 mm] back to back handle pulls:

CRT-GDP18 x 630 (Stainless Steel)

CRT-GDP18 x 622 (Black finish)

For 36" [914 mm] back to back handle pulls:

CRT-GDP36 x 630 (Stainless Steel)

CRT-GDP36 x 622 (Black finish)





NEW TECHNOLOGY FROM KN CROWDER
CLOSES SLOWLY, SAFELY AND SILENTLY

CATCH 'N' CLOSE[®]

Closes safely and silently

Crowdertrack's revolutionary technology allows sliding doors to close and stay closed -- safely, securely and silently, all with the introduction of the Catch'N'Close[®] closing system --

Bouncing and slamming is no longer an issue for Crowdertrack's sliding doors as the Catch'N'Close technology allows for smooth and controlled opening and closing of the door. The door will automatically slow and shut itself for the final few inches as the door travels to the open/closed position. No more jamming fingers or slamming doors.

"Safety is a top concern at Crowder. The Catch'N'Close closing system allows the door to safely and securely close," said Jeremy Crowder, Vice President K.N. Crowder.

THE BENEFITS:

Silent close

If noise reduction and privacy is a priority, the Catch'N'Close closing system is ideal. Condominiums, hotels, hospitals, offices, conference rooms, long-term care facilities, bedrooms and bathrooms are just a few spaces that can benefit from this new technology.

Safety

The Catch'N'Close closing system eliminates accidental closure of the door on users' fingers. Residential and commercial facilities who are catering to small children, the elderly, or individuals who require additional care are perfect candidates for the system.

Ease of use

The Catch'N'Close closing system is extremely user friendly as the door gently glides into the open/closed position without user assistance. The user is no longer responsible for ensuring that the door is either in the fully open or closed position as the Catch'N'Close mechanism does it for them.

The Technology

K.N. Crowder is the first to use the gas spring technology to create a top of the line door closing system. The closing system can be installed on both the opening and closing ends of doors up to 300 lbs. [136 kg] or as narrow as 18 inches [457.2 mm] wide. It has been cycle tested for up to 50,000 cycles without fail. The Catch'N'Close closing system has the unique ability to safeguard the door and hardware from wear and tear. The system eliminates slamming; protecting the user, the door and the door frame.

Installation

The installation is easy as the Catch'N'Close closing system is hidden inside the Crowdertrack and requires no additional installation efforts. The product can be used on top/side mounted doors, pocket doors, single and bi-parting doors and some barn door applications. In the event there is any issue, or customers want to replace the closing device with a new one, there is no need to take apart the door or wall as the new closing system can easily be accessed or installed/removed from underneath the track.

"Our customers have always wanted quality, highly functional products that look great! The Catch'N'Close closing system fits nicely into our collection of quality sliding door hardware", said Jeremy Crowder, Vice President K.N. Crowder.



See it in action!



EXPOSED BARN DOOR SYSTEMS
ARCHITECTURE & DESIGN COLLECTION

CATCH 'N' CLOSE®

Closes safely and silently

CROWDER FLAT TRACK SERIES



Up to 300 lbs. [136 kg] per door

Crowder Flat Track 200 series features our classic top mount hangers for an ultra-modern look.

4" [101.6 mm] Delrin wheels combined with our precision ball bearings provide extremely smooth and quiet door operation. The Catch'N'Close closing system gently guides the door into position without any assistance. The precision-machined 304 stainless steel solid flat track and hardware are polished to a satin finish.



How to Specify/Order:

Kit Code: CFT-[]-201-SS X [track length] 1DR KIT

[] = maximum door weight (CC1 for 150 lbs. [68 kg], CC2 for 200 lbs. [91 kg] or CC3 for 300 lbs. [136 kg])

Note: [track length] = door width x 2 (for 1 door kits)

Optional Door Handle Pulls:

For 18" [457 mm] back to back handle pulls:

CFT-DP18 x 630 (Stainless Steel)

For 36" [914 mm] back to back handle pulls:

CFT-DP36 x 630 (Stainless Steel)





EXPOSED BARN DOOR SYSTEMS
ARCHITECTURE & DESIGN COLLECTION

CATCH'N'CLOSE®

Closes safely and silently

CROWDER FLAT TRACK SERIES



Up to 300 lbs. [136 kg] per door

Crowder Flat Track 200 series features our classic top mount hangers for an ultra-modern look.

4" [101.6 mm] Delrin wheels combined with our precision ball bearings provide extremely smooth and quiet door operation. The Catch'N'Close closing system gently guides the door into position without any assistance. The precision-machined 304 stainless steel solid flat track and hardware are given a black finish.



How to Specify/Order:

Kit Code: CFT-[]-201-BP X [track length] 1DR KIT

[] = maximum door weight (CC1 for 150 lbs. [68 kg], CC2 for 200 lbs. [91 kg] or CC3 for 300 lbs. [136 kg])

Note: [track length] = door width x 2 (for 1 door kits)

Optional Door Handle Pulls:

For 18" [457 mm] back to back handle pulls:

CFT-DP18 x 622 (Black finish)

For 36" [914 mm] back to back handle pulls:

CFT-DP36 x 622 (Black finish)





EXPOSED BARN DOOR SYSTEMS
ARCHITECTURE & DESIGN COLLECTION

CATCH'N'CLOSE®

Closes safely and silently

CROWDER FLAT TRACK SERIES



Up to 300 lbs. [136 kg] per door



Crowder Flat Track 200 series features our classic strap mount hangers for an ultra-modern look.

4" [101.6 mm] Delrin wheels combined with our precision ball bearings provide extremely smooth and quiet door operation. The Catch'N'Close closing system gently guides the door into position without any assistance. The precision-machined 304 stainless steel solid flat track and hardware are polished to a satin finish.



How to Specify/Order:

Kit Code: CFT-[]-202-SS X [track length] 1DR KIT (For 1-3/4" [44.5 mm] door)

Kit Code: CFT-[]-202-38-SS X [track length] 1DR KIT (For 1-3/8" [34.9 mm] door)

[] = maximum door weight (CC1 for 150 lbs. [68 kg], CC2 for 200 lbs. [91 kg] or CC3 for 300 lbs. [136 kg])

Note: [track length] = door width x 2 (for 1 door kits)

Optional Door Handle Pulls:

For 18" [457 mm] back to back handle pulls:

CFT-DP18 x 630 (Stainless Steel)

For 36" [914 mm] back to back handle pulls:

CFT-DP36 x 630 (Stainless Steel)





EXPOSED BARN DOOR SYSTEMS
ARCHITECTURE & DESIGN COLLECTION

CATCH 'N' CLOSE®

Closes safely and silently

CROWDER FLAT TRACK SERIES



Up to 300 lbs. [136 kg] per door

Crowder Flat Track 200 series features our classic strap mount hangers for an ultra-modern look.



1-3/4"

4" [101.6 mm] Delrin wheels combined with our precision ball bearings provide extremely smooth and quiet door operation. The Catch'N'Close closing system gently guides the door into position without any assistance. The precision-machined 304 stainless steel solid flat track and hardware are given a black finish.



1-3/8"

How to Specify/Order:

Kit Code: CFT-[]-202-BP X [track length] 1DR KIT (For 1-3/4" [44.5 mm] door)

Kit Code: CFT-[]-202-38-BP X [track length] 1DR KIT (For 1-3/8" [34.9 mm] door)

[] = maximum door weight (CC1 for 150 lbs. [68 kg], CC2 for 200 lbs. [91 kg] or CC3 for 300 lbs. [136 kg])

Note: [track length] = door width x 2 (for 1 door kits)

Optional Door Handle Pulls:

For 18" [457 mm] back to back handle pulls:

CFT-DP18 x 622 (Black finish)

For 36" [914 mm] back to back handle pulls:

CFT-DP36 x 622 (Black finish)





EXPOSED BARN DOOR SYSTEMS
ARCHITECTURE & DESIGN COLLECTION

CATCH'N'CLOSE®

Closes safely and silently

CROWDER FLAT TRACK SERIES FOR GLASS DOORS

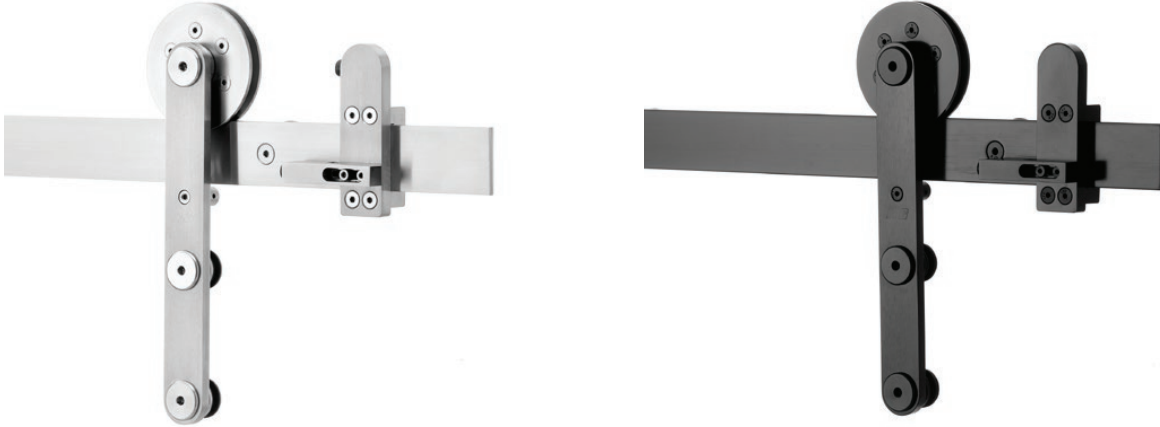

CFT-203-SS & CFT-203-BP
Up to 300 lbs. [136 kg] per door

Crowder Flat Track 200 series features our classic strap mount hangers for glass doors.



4" [101.6 mm] Delrin wheels combined with our precision ball bearings provide extremely smooth and quiet door operation. The Catch'N'Close closing system gently guides the door into position without any assistance. The precision-machined 304 stainless steel solid flat track and hardware are finished in black or polished to a satin finish.



How to Specify/Order:

Kit Code: CFT-[]-203-12-SS X [track length] 1DR KIT (for 1/2" [12 mm] Glass & Stainless Steel)

Kit Code: CFT-[]-203-38-SS X [track length] 1DR KIT (for 3/8" [10 mm] Glass & Stainless Steel)

Kit Code: CFT-[]-203-12-BP X [track length] 1DR KIT (for 1/2" [12 mm] Glass & Black Finish)

Kit Code: CFT-[]-203-38-BP X [track length] 1DR KIT (for 3/8" [10 mm] Glass & Black Finish)

[] = maximum door weight (CC1 for 150 lbs. [68 kg], CC2 for 200 lbs. [91 kg] or CC3 for 300 lbs. [136 kg])

Note: [track length] = door width x 2 (for 1 door kits)

Optional Door Handle Pulls:

For 18" [457 mm] back to back handle pulls:

CFT-GDP18 x 630 (Stainless Steel)

CFT-GDP18 x 622 (Black finish)

For 36" [914 mm] back to back handle pulls:

CFT-GDP36 x 630 (Stainless Steel)

CFT-GDP36 x 622 (Black finish)



CATCH 'N' CLOSE[®]
Closes safely and silently

Coming Soon!

CROWDER J-TRACK 300 SERIES

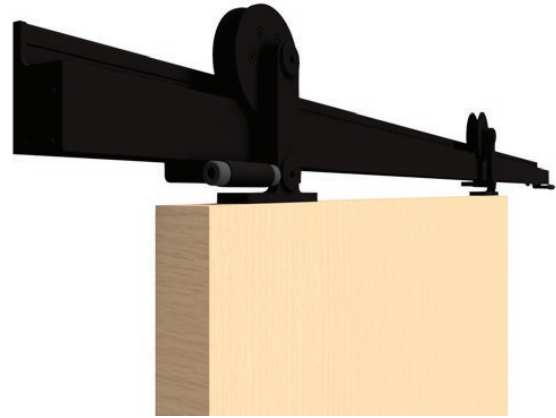

CJT-CC-301

Crowder J-Track 300 Series features our classic top mount hangers. This series is ideal for customizing the colour of your track!

Our precision ball bearings and Delrin wheels provide extremely smooth and quiet door operation. The Catch'N'Close closing system completes the package by gently guiding the door into position without any assistance.

This extruded aluminum track can be anodized, powder coated or painted any colour you can come up with.



How to Specify/Order:

Please contact KN Crowder at customerservice@kncrowder.com or 1-866-999-1KNC(1562) for more information.

CATCH 'N' CLOSE[®]
Closes safely and silently

Coming Soon!

CROWDER J-TRACK 300 SERIES



CJT-CC-302

Crowder J-Track 300 Series features our classic strap mount hangers. This series is ideal for customizing the colour of your track!

Our precision ball bearings and Delrin wheels provide extremely smooth and quiet door operation. The Catch'N'Close closing system completes the package by gently guiding the door into position without any assistance.

This extruded aluminum track can be anodized, powder coated or painted any colour you can come up with.



How to Specify/Order:

Please contact KN Crowder at customerservice@kncrowder.com or 1-866-999-1KNC(1562) for more information.



CEILING TRACK SYSTEMS

ARCHITECTURE & DESIGN COLLECTION

CATCH'N'CLOSE®

Closes safely and silently

ZERO CLEARANCE CATCH'N'CLOSE HANGERS

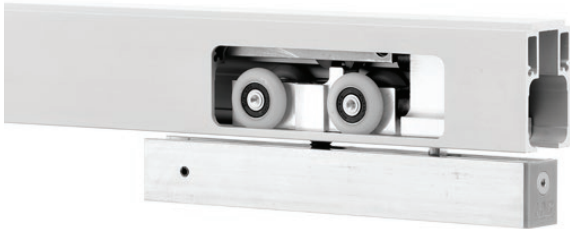

CC-810

Up to 300 lbs. [136 kg] per door



CC-410

Up to 150 lbs. [68 kg] per door



Minimalistic by design, the CC-810 and CC-410 hangers remove distraction from the room. The minimal clearance reduces light and sound entry, making it the ultimate sliding door system.

Our nylon wheels with precision ball bearings allow for smooth and quiet door operation. The Catch'N'Close closing system gently guides the door into position without any assistance.

Available in clear, bronze or black anodized, mill finish or powder-coated.



How to Specify/Order:

Kit Code: CC-[]-810 X [track length] 1DR KIT

[] = maximum door weight (2 for 200 lbs. [91 kg] or 3 for 300 lbs. [136 kg])

Kit Code: CC-[]-410-W X [track length] 1DR KIT (ideal for 1-3/4" [44.5 mm] doors)

Kit Code: CC-[]-410-B X [track length] 1DR KIT (ideal for 1-3/8" [34.9 mm] doors)

[] = maximum door weight (75 for 75 lbs. [34 kg] or 1 for 150 lbs. [68 kg])

Note: [track length] = door width x 2 (for 1 door kits)



CEILING TRACK SYSTEMS
ARCHITECTURE & DESIGN COLLECTION

CATCH'N'CLOSE®

Closes safely and silently

EASY CONNECT CATCH'N'CLOSE HANGERS



CC-993

Up to 200 lbs. [91 kg] per door



CC-493

Up to 150 lbs. [68 kg] per door



For a quick and easy install, the CC-993 and CC-493 hangers are perfect for the job. The top plate is mounted to the top of the door and accepts the Easy Connect stud, therefore reducing installation time.

Our nylon wheels with precision ball bearings allow for smooth and quiet door operation. The Catch'N'Close closing system gently guides the door into position without any assistance.

Available in clear, bronze or black anodized, mill finish or powder-coated.



How to Specify/Order:

Kit Code: CC-2-993 X [track length] 1DR KIT

Kit Code: CC-[]-493-W X [track length] 1DR KIT (ideal for 1-3/4" [44.5 mm] doors)

Kit Code: CC-[]-493-B X [track length] 1DR KIT (ideal for 1-3/8" [34.9 mm] doors)

[] = maximum door weight (75 for 75 lbs. [34 kg] or 1 for 150 lbs. [68 kg])

Note: [track length] = door width x 2 (for 1 door kits)



DRYWALL CEILING TRACK
ARCHITECTURE & DESIGN COLLECTION

CATCH 'N' CLOSE®

Closes safely and silently

DRYWALL CEILING TRACK

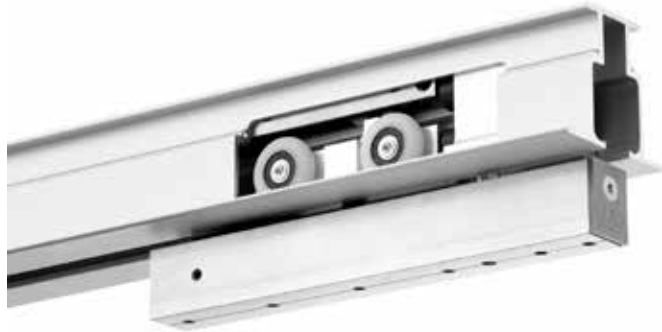

CCDC-810

Up to 300 lbs. [136 kg] per door

Minimalistic by design, the CC-810 zero clearance hanger paired with the CC-905 drywall ceiling track remove distraction from the room by levelling the track with the ceiling. The CC-810 hangers reduce light and sound entry, while our nylon wheels with precision ball bearings allow for smooth and quiet door operation. The addition of the Catch 'N' Close closing system enables the door to glide into position without assistance.

Available in clear, bronze or black anodized or powder-coated.



How to Specify/Order:

Kit Code: CCDC-[]-810 X [track length] 1DR KIT

[] = maximum door weight (2 for 200 lbs. [91 kg] or 3 for 300 lbs. [136 kg])

Note: [track length] = door width x 2 (for 1 door kits)

CATCH 'N' CLOSE™
Closes safely and silently

BARN DOOR SYSTEMS
ARCHITECTURE & DESIGN COLLECTION

CATCH'N'CLOSE®
Closes safely and silently

**ZERO CLEARANCE
CATCH'N'CLOSE HANGER**



CCB-810

Up to 300 lbs. [136 kg] per door

**EASY CONNECT
CATCH'N'CLOSE HANGER**



CCB-993

Up to 200 lbs. [91 kg] per door



Sleek and simple, these side-mounted kit combinations feature a modern track with subtle detailing that can be paired with our zero clearance hangers to minimize light and sound entry or with our Easy Connect hangers for a quick and easy install.



Our nylon wheels with precision ball bearings always make for smooth and quiet door operation. Our patented Catch'N'Close closing system adds to the sleekness by gently guiding the door into position without any assistance.

Available in clear, bronze or black anodized or powder-coated.

How to Specify/Order:

Kit Code: CCB-[]-810 X [track length] 1DR KIT

[] = maximum door weight (2 for 200 lbs. [91 kg] or 3 for 300 lbs. [136 kg])

Kit Code: CCB-2-993 X [track length] 1DR KIT

Note: [track length] = door width x 2 (for 1 door kits)



BARN DOOR SYSTEMS
ARCHITECTURE & DESIGN COLLECTION

CATCH'N'CLOSE®
Closes safely and silently

ZERO CLEARANCE CATCH'N'CLOSE HANGERS



CCS-810

Up to 300 lbs. [136 kg] per door



CCS-410

Up to 150 lbs. [68 kg] per door



For a more elementary look, these side-mounted kit combinations pair a one-piece track with hangers that minimize light and sound entry.

Our nylon wheels with precision ball bearings allow for smooth and quiet door operation. The Catch'N'Close closing system gently guides the door into position without any assistance.

Available in clear, bronze or black anodized or powder-coated.



How to Specify/Order:

Kit Code: CCS-[]-810 X [track length] 1DR KIT

[] = maximum door weight (2 for 200 lbs. [91 kg] or 3 for 300 lbs. [136 kg])

Kit Code: CCS-[]-410-W X [track length] 1DR KIT (ideal for 1-3/4" [44.5 mm] doors)

Kit Code: CCS-[]-410-B X [track length] 1DR KIT (ideal for 1-3/8" [34.9 mm] doors)

[] = maximum door weight (75 for 75 lbs. [34 kg] or 1 for 150 lbs. [68 kg])

Note: [track length] = door width x 2 (for 1 door kits)



BARN DOOR SYSTEMS
ARCHITECTURE & DESIGN COLLECTION

CATCH'N'CLOSE®

Closes safely and silently

EASY CONNECT CATCH'N'CLOSE HANGERS



CCS-993

Up to 200 lbs. [91 kg] per door



CCS-493

Up to 150 lbs. [68 kg] per door



For a quick and easy install, the CC-993 and CC-493 hangers are perfect for the job. The top plate is mounted to the top of the door and accepts the Easy Connect stud, therefore reducing installation time.

Our nylon wheels with precision ball bearings allow for smooth and quiet door operation. The Catch'N'Close closing system gently guides the door into position without any assistance.

Available in clear, bronze or black anodized or powder-coated.



How to Specify/Order:

Kit Code: CCS-2-993 X [track length] 1DR KIT

Kit Code: CCS-[]-493-W X [track length] 1DR KIT (ideal for 1-3/4" [44.5 mm] doors)

Kit Code: CCS-[]-493-B X [track length] 1DR KIT (ideal for 1-3/8" [34.9 mm] doors)

[] = maximum door weight (75 for 75 lbs. [34 kg] or 1 for 150 lbs. [68 kg])

Note: [track length] = door width x 2 (for 1 door kits)



BARN DOOR SYSTEMS
ARCHITECTURE & DESIGN COLLECTION

CATCH'N'CLOSE®
Closes safely and silently

ZERO CLEARANCE CATCH'N'CLOSE HANGERS

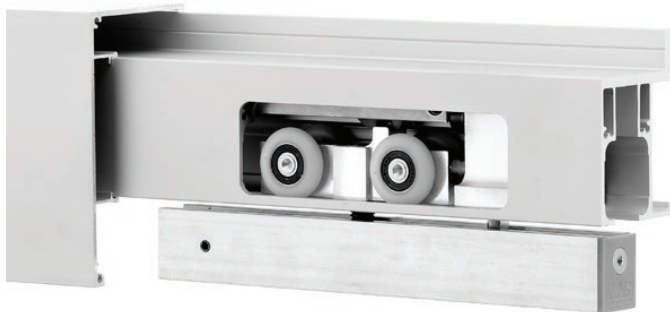

CCSF-810

Up to 300 lbs. [136 kg] per door



CCL-410

Up to 150 lbs. [68 kg] per door



For an ultra-modern look, these kit combinations feature a smooth undetailed fascia that can be clear, bronze or black anodized, or powder-coated any colour to add to your vision. The zero clearance hangers reduce light and sound entry, along with the visual space between the track and door, making it the ultimate sliding barn door system.

Our nylon wheels with precision ball bearings always make for smooth and quiet door operation. Our patented Catch'N'Close closing system adds to the sleekness by gently guiding the door into position without any assistance.



How to Specify/Order:

Kit Code: CCSF-[]-810 X [track length] 1DR KIT

[] = maximum door weight (2 for 200 lbs. [91 kg] or 3 for 300 lbs. [136 kg])

Kit Code: CCL-[]-410-W X [track length] 1DR KIT (ideal for 1-3/4" [44.5 mm] doors)

Kit Code: CCL-[]-410-B X [track length] 1DR KIT (ideal for 1-3/8" [34.9 mm] doors)

[] = maximum door weight (75 for 75 lbs. [34 kg] or 1 for 150 lbs. [68 kg])

Note: [track length] = door width x 2 (for 1 door kits)



BARN DOOR SYSTEMS
ARCHITECTURE & DESIGN COLLECTION

CATCH'N'CLOSE®

Closes safely and silently

EASY CONNECT CATCH'N'CLOSE HANGERS



CCSF-993

Up to 200 lbs. [91 kg] per door



CCSF-493

Up to 150 lbs. [68 kg] per door



For a more uniform look, this all-in-one side-mounted kit covers the track and any gap between the track and door. Equipped with our Easy Connect hangers, this kit makes installation a breeze.

Our nylon wheels with precision ball bearings always make for smooth and quiet door operation. Our patented Catch'N'Close closing system adds to the sleekness by gently guiding the door into position without any assistance.

Available in clear, bronze or black anodized or powder-coated.



How to Specify/Order:

Kit Code: CCSF-2-993 X [track length] 1DR KIT

Kit Code: CCSF-[]-493-W X [track length] 1DR KIT (ideal for 1-3/4" [44.5 mm] doors)

Kit Code: CCSF-[]-493-B X [track length] 1DR KIT (ideal for 1-3/8" [34.9 mm] doors)

[] = maximum door weight (75 for 75 lbs. [34 kg] or 1 for 150 lbs. [68 kg])

Note: [track length] = door width x 2 (for 1 door kits)



BYPASS SYSTEMS
ARCHITECTURE & DESIGN COLLECTION

CATCH'N'CLOSE®

Closes safely and silently

ZERO CLEARANCE CATCH'N'CLOSE HANGER

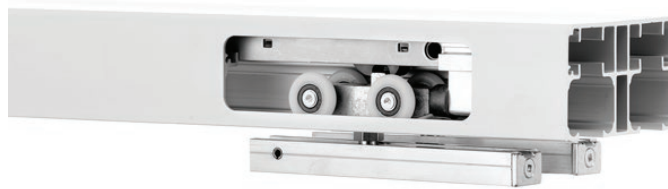

CCD-410

Up to 150 lbs. [68 kg] per door

Our bypass systems are now available with Catch'N'Close.

This kit includes our zero clearance hangers which reduce light and sound entry, along with the visual space between the track and the door, making it the ultimate bypass system.

As always, our nylon wheels with precision ball bearings allow for smooth and quiet door operation. The addition of the Catch'N'Close closing system enables the door to glide into position without any assistance.

Available in clear, bronze or black anodized, mill finish or powder-coated.



How to Specify/Order:

Kit Code: CCD-[]-410-W X [track length] 2DR KIT (ideal for 1-3/4" [44.5 mm] doors)

Kit Code: CCD-[]-410-38-B X [track length] 2DR KIT (ideal for 1-3/8" [34.9 mm] doors)

[] = maximum door weight (75 for 75 lbs. [34 kg] or 1 for 150 lbs. [68 kg])

Note: [track length] = door width x 2 (for 2 door kits)



BYPASS SYSTEMS
ARCHITECTURE & DESIGN COLLECTION

CATCH 'N' CLOSE®

Closes safely and silently

EASY CONNECT CATCH 'N' CLOSE HANGER



CCD-493

Up to 150 lbs. [68 kg] per door

Our bypass systems are now available with Catch'N'Close.

For a quick and easy install, choose our CC-493 hanger. The top plate is mounted to the top of the door and accepts the Easy Connect stud, therefore reducing installation time.

As always, our nylon wheels with precision ball bearings allow for smooth and quiet door operation. The addition of the Catch'N'Close closing system enables the door to glide into position without any assistance.

Available in clear, bronze or black anodized, mill finish or powder-coated.



How to Specify/Order:

Kit Code: CCD-[]-493-W X [track length] 2DR KIT (ideal for 1-3/4" [44.5 mm] doors)

Kit Code: CCD-[]-493-38-B X [track length] 2DR KIT (ideal for 1-3/8" [34.9 mm] doors)

[] = maximum door weight (75 for 75 lbs. [34 kg] or 1 for 150 lbs. [68 kg])

Note: [track length] = door width x 2 (for 2 door kits)



CATCH 'N' CLOSE®
Closes safely and silently

CATCH 'N' CLOSE GLASS HANGERS

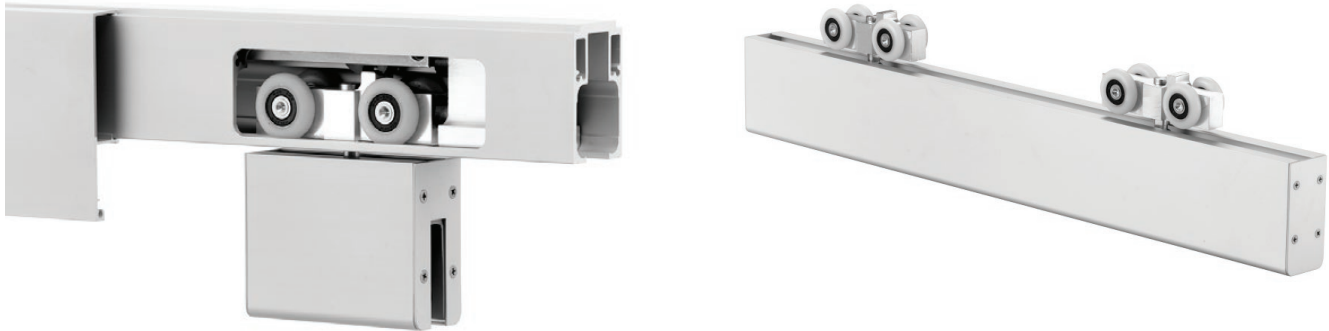

Up to 300 lbs. [136 kg] per door

Effortless and worry-free describe the feeling of using our patented Catch'N'Close system with your glass doors. Each hanger comes with our signature precision ball bearing nylon wheels to ensure smooth and quiet operation. Our Catch'N'Close closing system enables the door to gently glide into position safely and without any assistance.

Continuous hanger and fascia are both options for this series and are available in clear, bronze or black anodized or powder-coated.



How to Specify/Order:

Please contact KN Crowder at customerservice@kncrowder.com or 1-866-999-1KNC(1562) for more information.



1

GLASS SYSTEMS
ARCHITECTURE & DESIGN COLLECTION

CATCH 'N' CLOSE[®]
Closes safely and silently

SIDE MOUNT CATCH 'N' CLOSE GLASS HANGERS



Up to 300 lbs. [136 kg] per door



Effortless and worry-free describe the feeling of using our patented Catch'N'Close system with your glass doors. Each hanger comes with our signature precision ball bearing nylon wheels to ensure smooth and quiet operation. Our Catch'N'Close closing system enables the door to gently glide into position safely and without any assistance.

Continuous hanger and fascia are both options for this series and are available in clear, bronze or black anodized or powder-coated.



How to Specify/Order:

Please contact KN Crowder at customerservice@kncrowder.com or 1-866-999-1KNC(1562) for more information.



CROWDERFRAME POCKET DOOR KITS
ARCHITECTURE & DESIGN COLLECTION

CATCH'N'CLOSE®

Closes safely and silently

CATCH'N'CLOSE CROWDERFRAME POCKET DOOR KIT HOW IT ALL COMES TOGETHER

TYPE CC-1W Catch'N'Close Crowderframe Pocket Door Kit shown

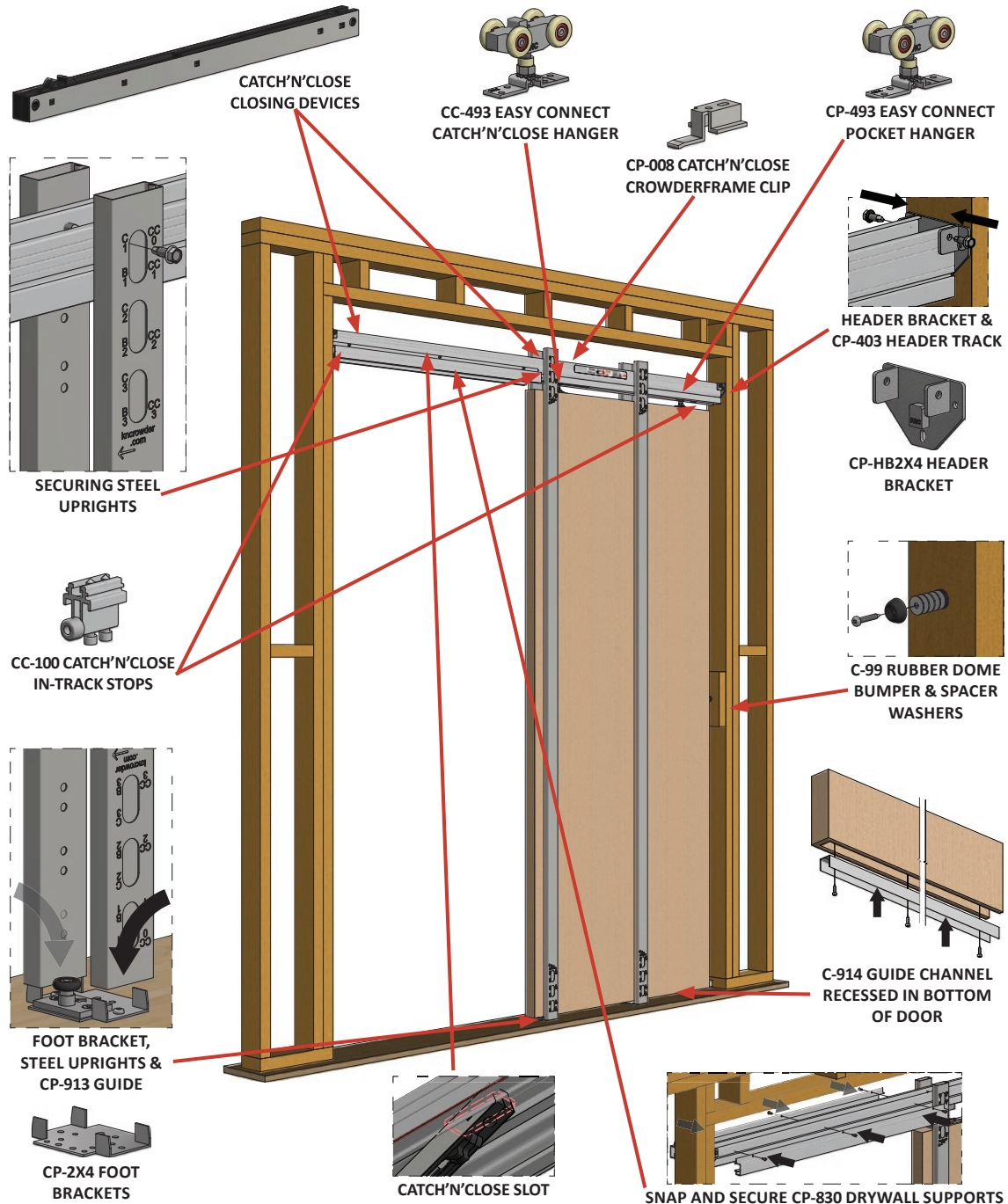



CROWDERFRAME POCKET DOOR KITS
ARCHITECTURE & DESIGN COLLECTION

CATCH 'N' CLOSE®

Closes safely and silently

2X6 HEAVY-DUTY POCKET DOOR KIT



New!

TYPE CC-HD-2X6

Up to 300 lbs. [136 kg] per door
For 2X6 Wall Construction

Our best-selling Crowderframe Pocket Door Kit now comes in a heavy-duty version specifically engineered for 2X6 wall construction! This complete kit eliminates the need for shim kits, making installation fast and easy. As always, our nylon wheels with precision ball bearings allow for smooth and quiet door operation. The Catch'N'Close closing system enables the door to glide into position without any assistance.



Additional features:

- Complete with larger, heavy-duty roll formed steel uprights for less deflection and easy to screw into for drywall fastening.
- The NEW CC-998 Easy Connect Top Mount Hangers allow you the choice to install the door before OR after the drywall goes up. They also allow for height and plumb adjustments while the door is up.
- New Catch'N'Close slot makes installation or replacement of Catch'N'Close devices simple. No removing trim, the door, or cutting into the drywall required.
- Faster and easier installation than a traditional pocket built on-site.
- For single or bi-parting door applications.

How to Specify/Order:

Type CC-2HD-2X6 Heavy-Duty 2X6 Catch'N'Close Crowderframe Pocket Door Kit
For maximum door weight of 200 lbs. [91 kg]

Type CC-3HD-2X6 Heavy-Duty 2X6 Catch'N'Close Crowderframe Pocket Door Kit
For maximum door weight of 300 lbs. [136 kg]

For doors from 30" [762 mm] to 72" [1828 mm] wide x 78" [1981 mm] to 120" [3048 mm] high, please provide door size when specifying/ordering.



CROWDERFRAME POCKET DOOR KITS
ARCHITECTURE & DESIGN COLLECTION

CATCH 'N' CLOSE®

Closes safely and silently

Our Catch'N'Close Crowderframe Pocket Door Kits have been perfected. In addition to our best-selling Type CC kit for 2X4 wall construction, we now offer a kit specifically engineered for 2X6 wall construction.



New!
TYPE CC-2X6
 For 2X6 Wall Construction
 Up to 150 lbs. [68 kg] per door

Improved!
TYPE CC
 For 2X4 Wall Construction
 Up to 150 lbs. [68 kg] per door

This addition to the line up eliminates the need for shim kits, making installation fast and easy. As always, our nylon wheels with precision ball bearings allow for smooth and quiet door operation. The Catch'N'Close closing system enables the door to glide into position without any assistance.

Additional features:

- Complete with roll formed steel uprights for less deflection and easy to screw into for drywall fastening.
- The NEW CC-493 Easy Connect Top Mount Hangers allow you the choice to install the door before OR after the drywall goes up. They also allow for height and plumb adjustments while the door is up.
- New Catch'N'Close slot makes installation or replacement of Catch'N'Close devices simple. No removing trim, the door, or cutting into the drywall required.
- Faster and easier installation than a traditional pocket built on-site.
- For single or bi-parting door applications.
- Trim kit available for 2X4 wall construction only (see pages 70-71).



How to Specify/Order:

Type CC-[]W-2X6 Catch'N'Close Crowderframe Pocket Door Kit (ideal for 1-3/4" [44.5 mm] doors in 2X6 wall construction)
 Type CC-[]W Catch'N'Close Crowderframe Pocket Door Kit (ideal for 1-3/4" [44.5 mm] doors in 2X4 wall construction)
 Type CC-[]B Catch'N'Close Crowderframe Pocket Door Kit (ideal for 1-3/8" [34.9 mm] doors in 2X4 wall construction)
 [] = maximum door weight (75 for 75 lbs. [34 kg] or 1 for 150 lbs. [68 kg])
 Available for doors from 30" [762 mm] to 48" [1219 mm] wide x 80" [2032 mm] to 120" [3048 mm] high, please provide door size when specifying/ordering.



CROWDERFRAME POCKET DOOR KITS

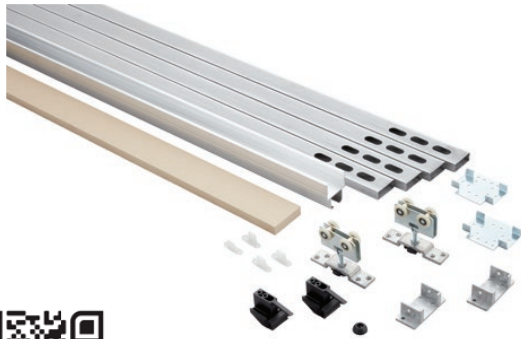

New!
TYPE C-2X6
 For 2X6 Wall Construction
 Up to 150 lbs. [68 kg] per door

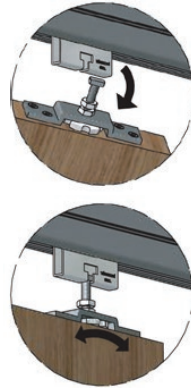

Improved!
TYPE C
 For 2X4 Wall Construction
 Up to 150 lbs. [68 kg] per door

Our Type C Crowderframe Pocket Door Kit now comes in a 2X6 version. This complete kit specifically engineered for 2X6 wall construction, eliminates the need for shim kits, making installation fast and easy. For a quick and easy install, we chose our C-411 Quick Release Hangers for these pocket door kits. Check out the drawings above to see how easily the door connects and adjusts! Our nylon wheels with precision ball bearings ensure smooth and quiet door operation.



Improved!
TYPE B
 For 2X4 Wall Construction
 Up to 125 lbs. [57 kg] per door



Our C-400 hangers combined with nylon wheels with precision ball bearings ensure smooth and quiet door operation.

Additional features for all kits above:

- Complete with roll formed steel uprights for less deflection and easy to screw into for drywall fastening.
- Choose to install the door before OR after the drywall goes up.
- Adjust door height and plumb while the door is up.
- Faster and easier installation than a traditional pocket built on-site.
- For single or bi-parting door applications.

How to Specify/Order:

Type C-W-2X6 Crowderframe Pocket Door Kit (ideal for 1-3/4" [44.5 mm] doors in 2X6 wall construction)

Type C-W Crowderframe Pocket Door Kit (ideal for 1-3/4" [44.5 mm] doors in 2X4 wall construction)

Available for doors from 18" [457 mm] to 48" [1219 mm] wide x 80" [2032 mm] to 120" [3048 mm] high, please provide door size when specifying/ordering.

Type B-B Crowderframe Pocket Door Kit (ideal for 1-3/8" [34.9 mm] doors)

Available for doors from 18" [457 mm] to 36" [914 mm] wide x 80" [2032 mm] to 96" [2438 mm] high, please provide door size when specifying/ordering.

FOR EXTRA WIDE AND/OR HIGH POCKET DOORS



All Crowderframe Pocket Door Kits are available to accommodate a wide range of door sizes. Depending on the kit, we can handle doors from 18" [457 mm] to 72" [1829mm] wide x 78" [1981 mm] to 120" [3048 mm] high and up to 2-1/2" [64 mm] thick.

How to Specify/Order:

Please contact KN Crowder at:
customerservice@kncrowder.com or
1-866-999-1KNC(1562) for more information.



FOR BI-PARTING POCKET DOORS



How to Specify/Order Add-On Products:

Joiner Kit

For bi-parting door applications, please specify as follows:

For 2X4 wall construction:

CPD-2X4-JOINER KIT as an add-on in addition to two (2) single Crowderframe Pocket Door Kits.

For 2X6 wall construction:

CPD-2X6-JOINER KIT as an add-on in addition to two (2) single 2X6 Crowderframe Pocket Door Kits.



SNAP-ON ALUMINUM CROWDERFRAME POCKET TRIM KIT



CP-TK-2X4 FOR TYPE CC CATCH'N'CLOSE POCKET DOOR KITS

The latest and greatest in pocket door framing! This kit is quick to install and allows easy access for any required maintenance. Bye-bye traditional wood trim finishing!

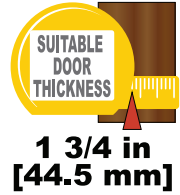

Key Product Features:

- Allows for the door to be installed after the drywall is in place
- No visible fasteners - simply caulk if desired and paint to finish
- Clear anodized finish, can be painted on-site or we can custom finish in advance
- This kit is specifically designed for standard 2X4 wall construction using 1/2" [12.7 mm] drywall and 1-3/4" [44.5 mm] doors
- Features our newly designed C-917 guide channel complete with pile insert to reduce sound and light transfer

TYPE CC-W CATCH'N'CLOSE CROWDERFRAME POCKET DOOR KIT WITH CP-TK-2X4 POCKET TRIM KIT DIMENSION DETAILS

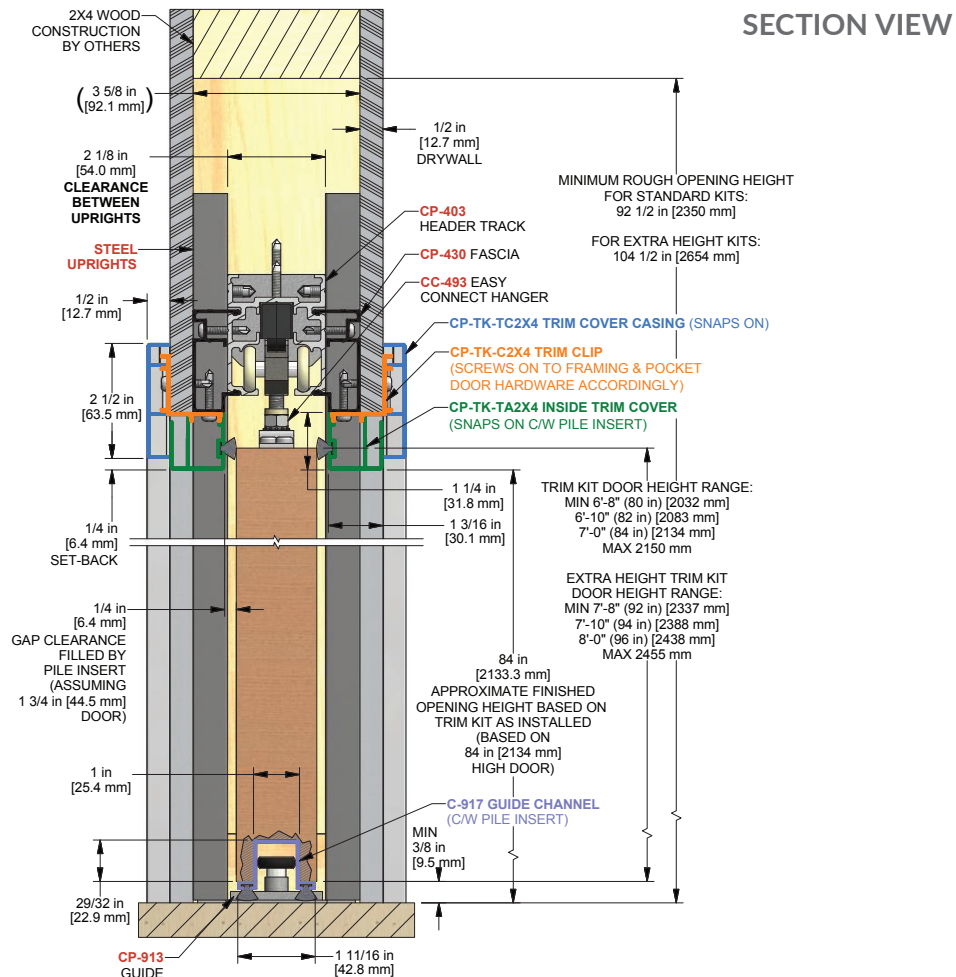

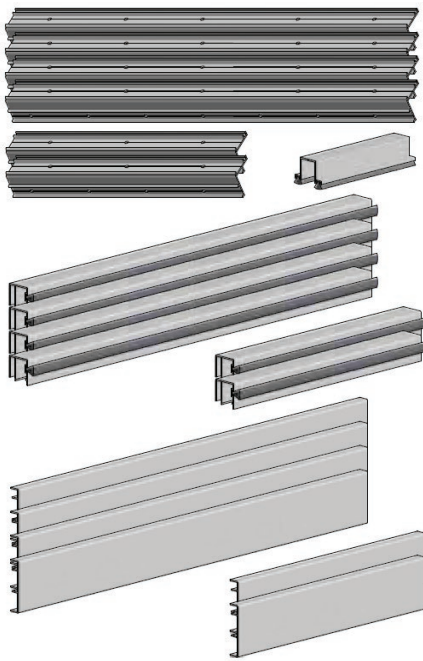

HOW TO SPECIFY/ORDER:

KIT CODE: CP-TK-2X4

For applications where a single TYPE CC-W CATCH'N'CLOSE CROWDERFRAME POCKET DOOR KIT is used.

Suitable for one door kit from:

18" [457 mm] to 36" [914 mm] wide x 80" [2032 mm] to 84" [2134 mm] or 2150 mm high x 1-3/4" thick [44.5 mm]

FULL POCKET DOOR KIT is NOT included, must be purchased separately.

For other door sizes or custom applications, please contact KN Crowder at customerservice@kncrowder.com or 1-866-999-1KNC(1562) for more information.



TYPE CC-W CATCH'N'CLOSE CROWDERFRAME POCKET DOOR KIT WITH CP-TK-2X4 POCKET TRIM KIT DIMENSION DETAILS

PLAN VIEW

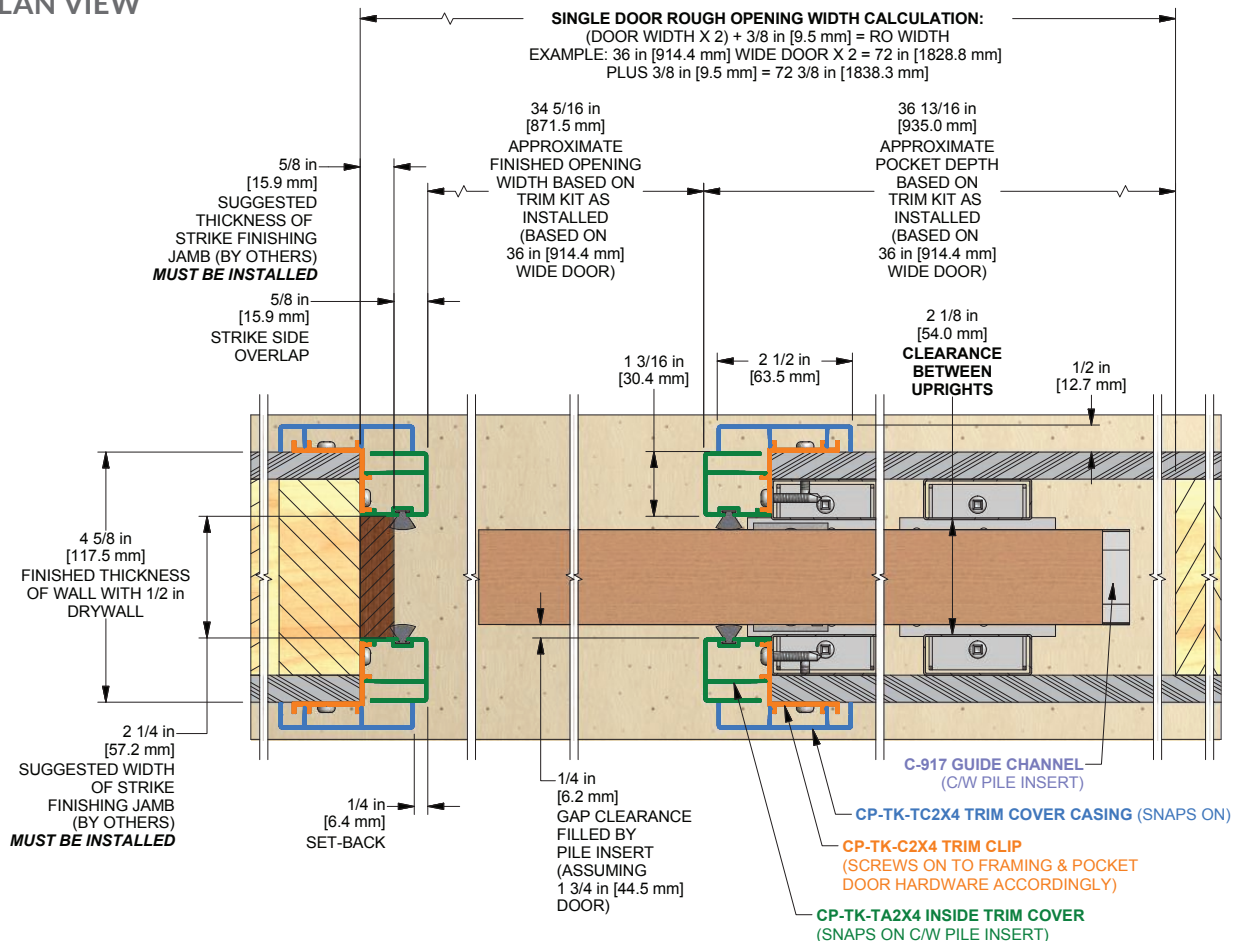

SOUND SEALING POCKET DOORS USING KNC WEATHERSTRIP PRODUCTS

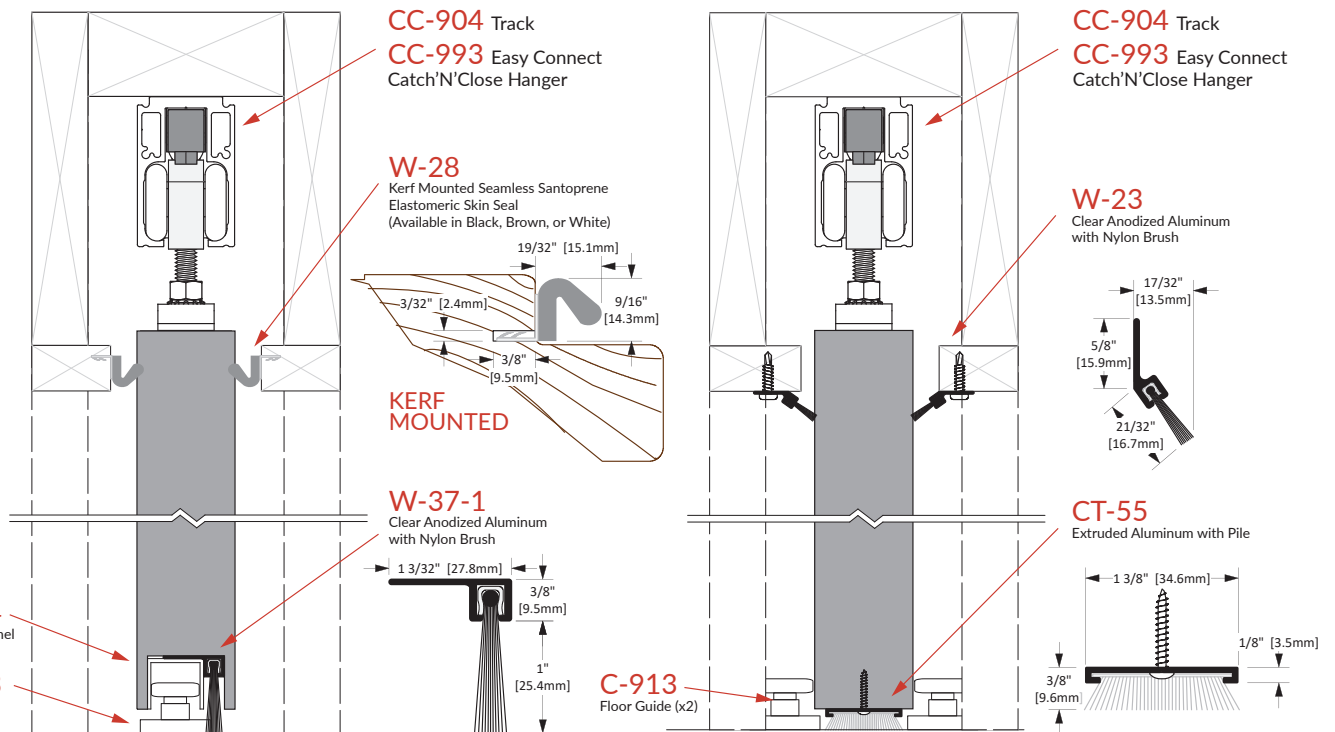
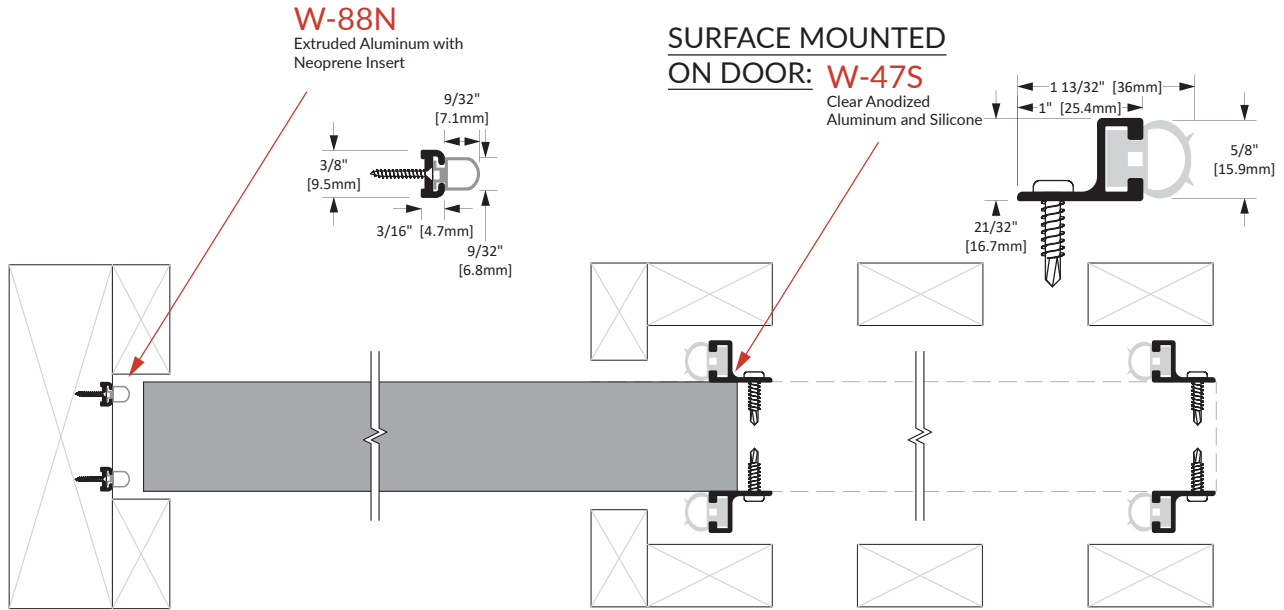

For more information on KNC Weatherstrip products please visit :
kncrowder.com/wstripping

NOTES: Pocket framing, header, and trim work by others.
For single track kits only.



LOCKING & LATCHING SOUND SEALING POCKET DOORS USING KNC WEATHERSTRIP PRODUCTS

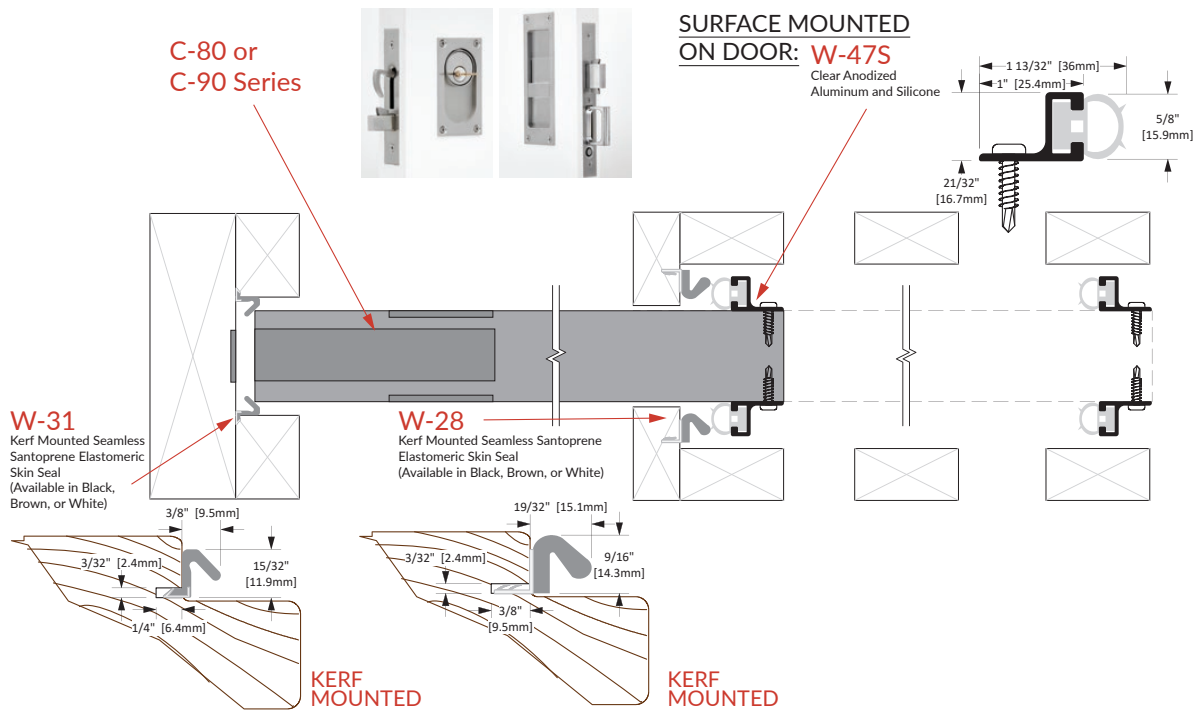

WEATHERSTRIP & AUTOMATIC DOOR BOTTOM OPTIONS

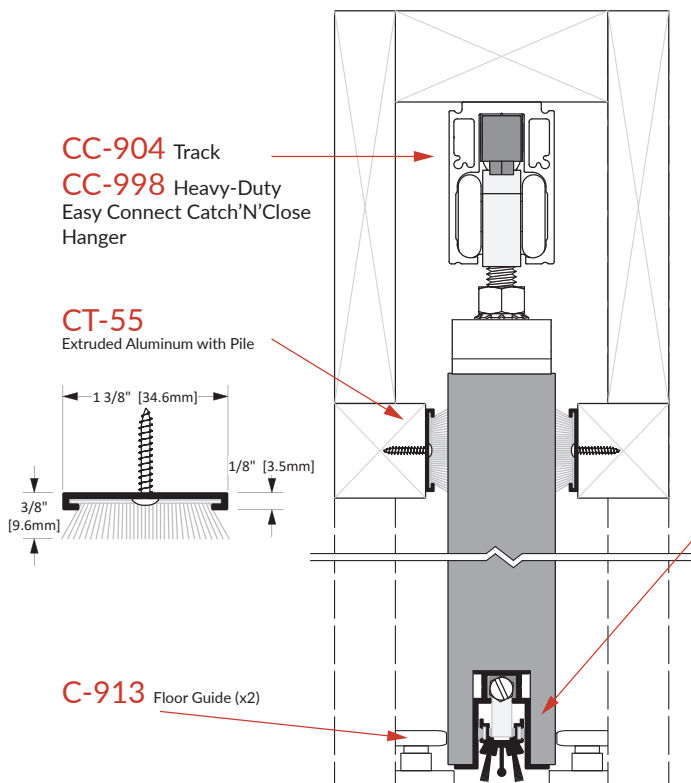

USING KNC'S AUTOMATIC DOOR BOTTOMS ON SLIDING DOORS

In order to use KNC's Automatic Door Bottoms, a sliding door lock must be installed to pull and hold the door shut which in turn will activate the ADB's plunger (see above for details). Two **C-913** Floor Guides will be required; one on each side of the door.

For more information on Automatic Door Bottoms please visit : kncrowder.com/autodoor

NOTES: Pocket framing, header, and trim work by others.

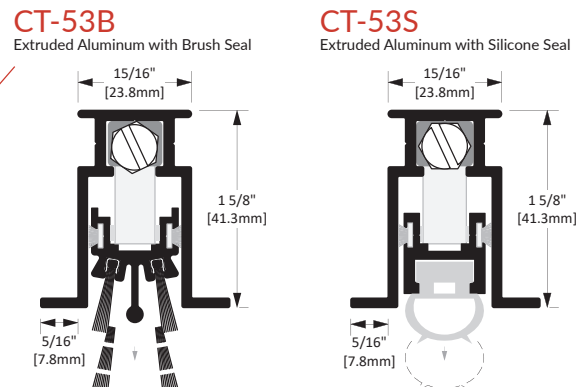



CUSTOM SYSTEMS

CROWDER STACK



CST-700 Series

Up to 200 lbs. [91 kg] per door

The Crowder Stack is a folding partition stacking door system that ranges from light to heavy-duty, taking care of all your room division needs. Ideal for convention centers, event venues, conference rooms, hospitality, etc. The applications are endless! Our strategically designed hangers come with axial bearings to carry the door and allow pivoting or cornering as required.



Coming Soon!

300 lbs. [136 kg] Heavy-Duty System

How to Specify/Order:

Please contact KN Crowder at customerservice@kncrowder.com or 1-866-999-1KNC(1562) for more information.



CUSTOM SYSTEMS

CATCH 'N' CLOSE®

Closes safely and silently

CROWDER COME-ALONG



CA-134-3

Up to 200 lbs. [91 kg] per door



CA-134-3HD HEAVY-DUTY

Up to 350 lbs. [159 kg] per door

This is the system of choice if you have multiple doors that need to move as one! Our Come-Along System allows all doors to move by simply opening/closing the lead door; successive doors follow along. This system also eliminates recessing guide channels in the floor.

Our patented Catch 'N' Close closing system can be added to enable the doors to glide into position without any assistance.

Track and hardware components are chosen separately to integrate with the Come-Along System.

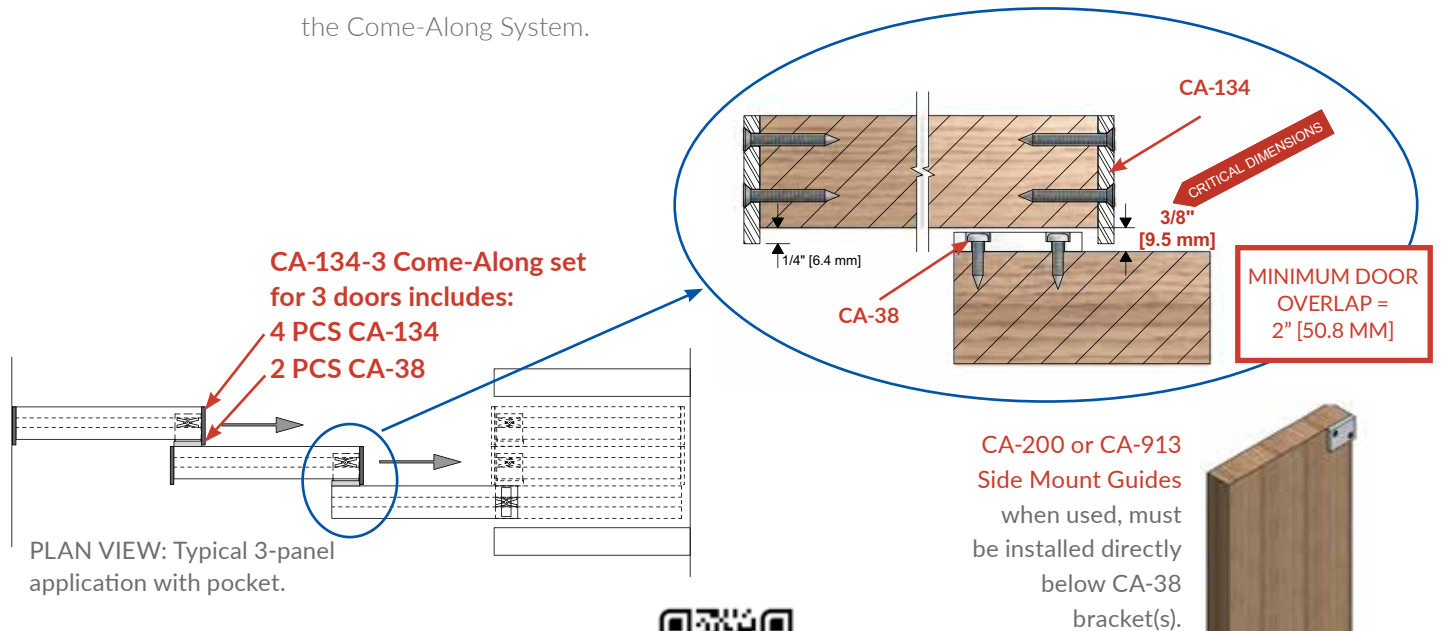

How to Specify/Order:

Please contact KN Crowder at customerservice@kncrowder.com or 1-866-999-1KNC(1562) for more information.



CUSTOM SYSTEMS

CROWDER DISPLAY

The Crowder Display System is a heavy-duty telescoping track system allowing individual panels to slide in and out, to view the elements on display.

For Retail Displays, this system may be used to showcase doors and door frames, slatwall or building material to name a few; maximizing use of expensive floor space.

Mounted in sturdy frame (by others), panels can be organized to minimize the space between them.

Manufactured to suit application requirements. The installation shown at lower right, produced 1600 sq. ft. [148.6 sq. m.] of display within 160 sq. ft. [14.9 sq. m.] of floor space.



How to Specify/Order:

Please contact KN Crowder at customerservice@kncrowder.com or 1-866-999-1KNC(1562) for more information.



CUSTOM SYSTEMS
HOSPITAL & OFFICE COLLECTION

CATCH 'N' CLOSE[®]

Closes safely and silently

Coming Soon!

CROWDER SLIDE

The Crowder Slide system is designed to finish off the entire opening with anodized or powder-coated aluminum snap-on covers and trim that create a seamless and uniform look. Using our Catch 'N' Close Barn Door Series, a full height strike jamb allows for privacy or security locksets to be used without the need to build a jamb out from the wall. This complete jamb, strike, and trim system comes with pile inserts to improve sound and light transmission around the door when closed.

Ideal for hospitality, medical, commercial and office applications.



How to Specify/Order:

Please contact KN Crowder at customerservice@kncrowder.com or 1-866-999-1KNC(1562) for more information.



CUSTOM SYSTEMS
HOSPITAL COLLECTION

CATCH 'N' CLOSE®

Closes safely and silently

CROWDER CANTILEVER



Our Cantilever System is essential for hospitals, assisted living spaces, or anywhere you would need a gap in the track. This system allows for a sliding door to travel over an opening in the track as wide as 16" [406mm]. These gaps are designed for specific needs such as a patient lift tracking system travelling from one room to the next. Our Catch 'N' Close closing system enables the door to glide into position without any assistance.

Available in clear, bronze or black anodized or a custom finish.

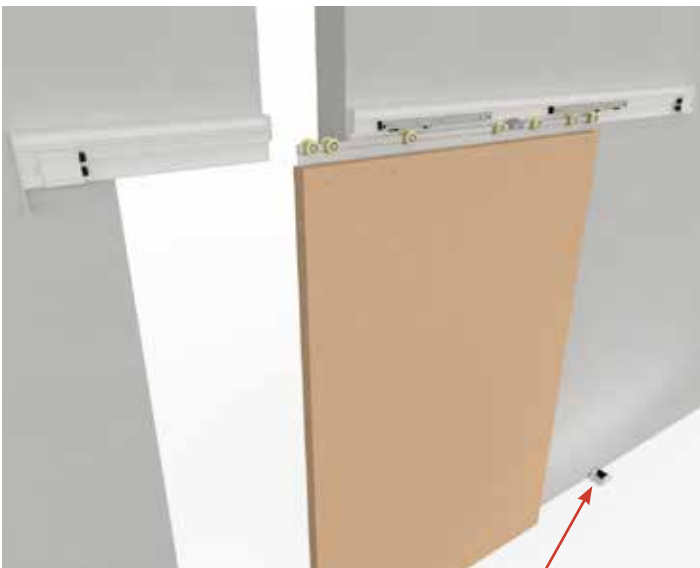

Heavy-Duty Floor Stop

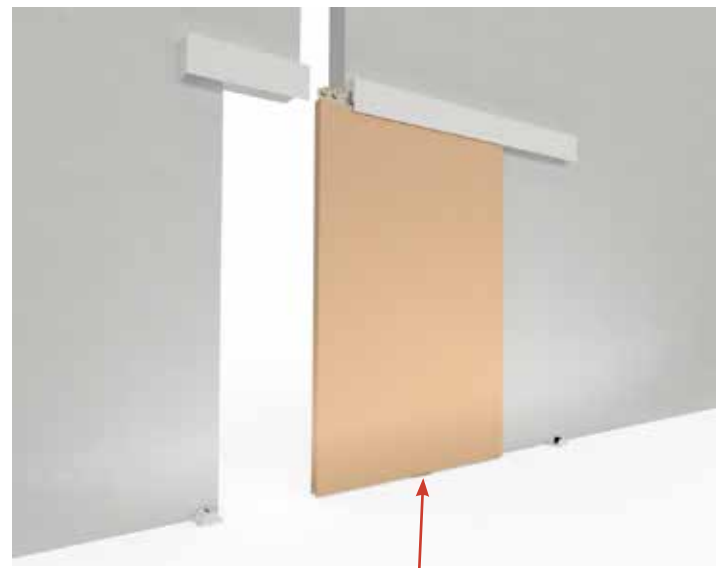

Guide System



How to Specify/Order:

Please contact KN Crowder at customerservice@kncrowder.com or 1-866-999-1KNC(1562) for more information.



CUSTOM SYSTEMS
HOSPITAL COLLECTION

CROWDER SECURITY

KNC has always aimed to make the highest quality sliding door track and hardware but also tackles new challenges and custom applications. This is where our one of a kind and a first in Canada, high security door system comes in. The Crowder Security system provides the standard smooth and quiet sliding door operation *with* the addition of security. This system is ideal for hospitals & high security facilities which will prevent users from tampering with the assembly or operation of the door.

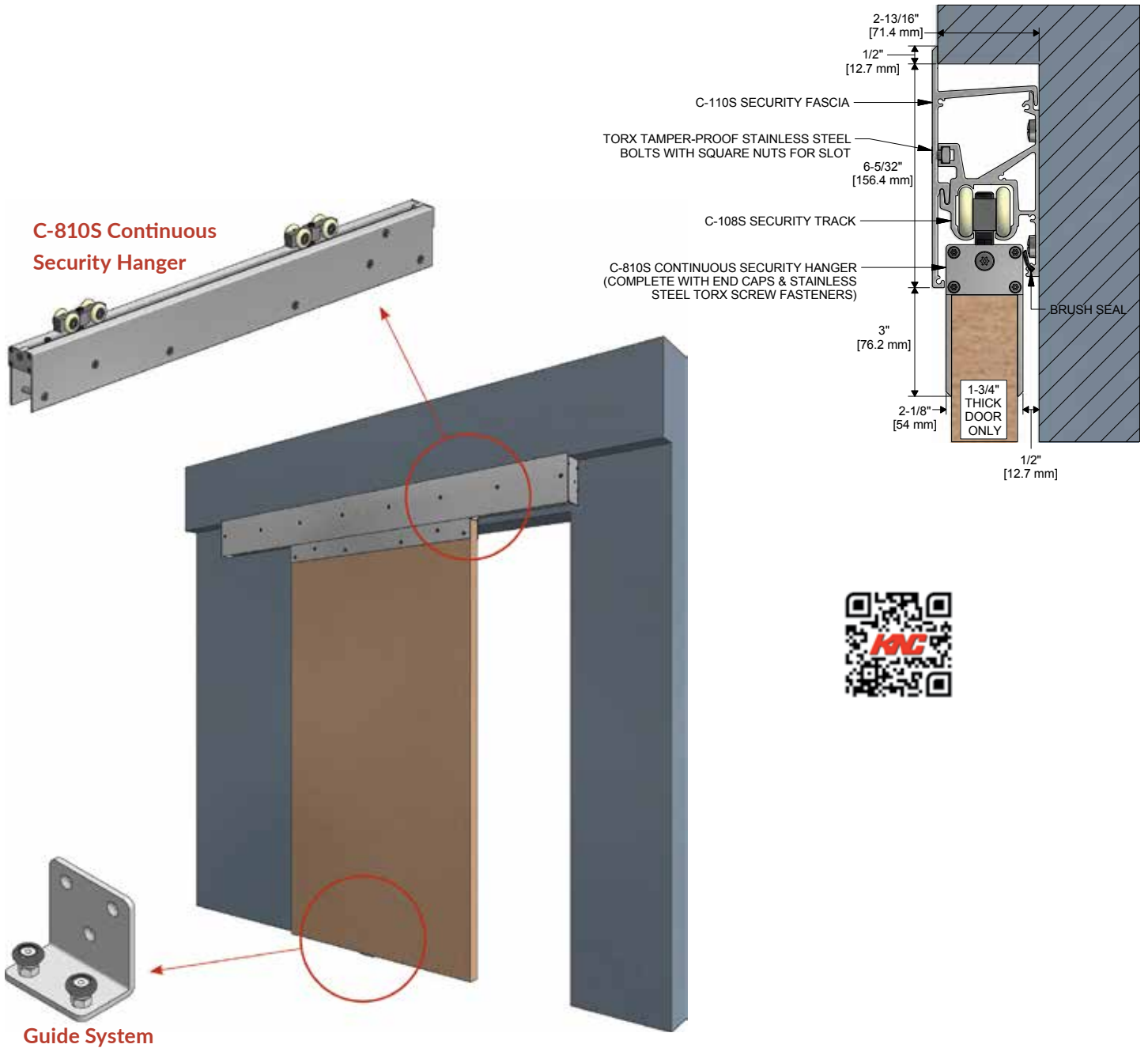

How to Specify/Order:

Please contact KNC Crowder at customerservice@kncrowder.com or 1-866-999-1KNC(1562) for more information.



CEILING TRACK SYSTEMS

ZERO CLEARANCE HANGERS



C-810

Up to 300 lbs. [136 kg] per door



C-410

Up to 150 lbs. [68 kg] per door



This ceiling track system allows for minimal clearance between the door and track, reducing light and sound entry. Our nylon wheels with precision ball bearings always ensure smooth and quiet door operation. This all-in-one kit comes with a wrench and Allen key for easy adjustment in the field.



Available in clear, bronze or black anodized, mill finish or powder-coated.

How to Specify/Order:

Kit Code: C-810 x [track length] 1DR KIT

Kit Code: C-410-W x [track length] 1DR KIT (ideal for 1-3/4" [44.5 mm] doors)

Kit Code: C-410-B x [track length] 1DR KIT (ideal for 1-3/8" [34.9 mm] doors)

Note: [track length] = door width x 2 (for 1 door kits)



CEILING TRACK SYSTEMS

QUICK RELEASE HANGER



C-911

Up to 200 lbs. [91 kg] per door

This heavy-duty hanger comes standard with nylon wheels and precision ball bearings for smooth and quiet door operation. Installation is fast and easy thanks to the Quick Release hanger assembly. Levelling and adjusting the height is also a breeze; only requiring one person.

Available in clear, bronze or black anodized, mill finish or powder-coated.

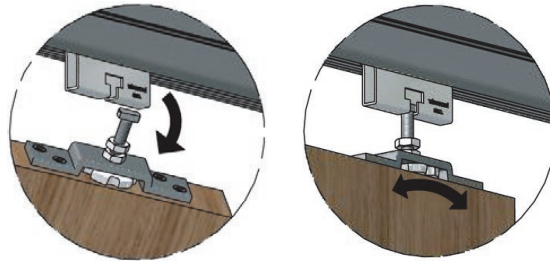

How to Specify/Order:

Kit Code: C-911 x [track length] 1DR KIT

Note: [track length] = door width x 2 (for 1 door kit)



HEAVY-DUTY CEILING TRACK SYSTEMS

NYLON WHEEL HANGERS

We have the capability to support extremely large and heavy doors; up to 450 lbs. [204 kg] per door! Our nylon wheels with precision ball bearings ensure smooth and quiet door operation. For top mounted, single, bi-parting, bypassing or pocket doors. Available in clear, bronze or black anodized, mill finish or powder-coated.



C-818-HD

Up to 450 lbs. [204 kg] per door



C-994

Up to 350 lbs. [159 kg] per door



C-993

Up to 250 lbs. [113 kg] per door



How to Specify/Order:

Kit Code: [hanger series] x [track length] 1DR KIT

Note: [track length] = door width x 2 (for 1 door kits)

E.G. C-818HD X 72" 1DR KIT



HEAVY-DUTY TRACK SYSTEMS

STEEL WHEEL HANGERS

We have the capability to support extremely large and heavy doors; up to 700 lbs. [318 kg] per door! Our precision ball bearing steel wheeled hanger kits work for top mounted, single, bi-parting, bypassing, pocket or side mounted doors.

Available in clear, bronze or black anodized, mill finish or powder-coated.



C-995

Up to 450 lbs. [204 kg] per door



C-207-8

Up to 700 lbs. [318 kg] per door



C-205-8

Up to 600 lbs. [272 kg] per door



C-207-4

Up to 500 lbs. [227 kg] per door



C-205-4

Up to 300 lbs. [136 kg] per door



C-206-4

Up to 225 lbs. [102 kg] per door



How to Specify/Order:

Kit Code: [hanger series] x [track length] 1DR KIT

Note: [track length] = door width x 2 (for 1 door kits)

E.G. C-207-8 X 72" 1DR KIT



EXTERIOR APPLICATIONS

STAINLESS STEEL HANGERS

Our stainless steel hangers are ideal for applications that are exposed to moisture, saltwater and other external factors. Installation is fast and easy thanks to the *Easy Connect Hanger* assembly. We recommend these hangers be teamed up with our C-104 or C-108 Crowdertrack in clear, bronze or black anodized.



New!

C-998-SS

Up to 450lbs. [205 kg] per door



C-400-SS

Up to 125lbs. [57 kg] per door



How to Specify/Order:

Please contact KN Crowder at customerservice@kncrowder.com or 1-866-999-1KNC(1562) for more information.



CEILING TRACK SYSTEMS

NYLON WHEEL HANGERS

For smooth and quiet door operation, choose our nylon wheel kits. Great for top mounted single, bi-parting, bypassing, or pocket doors.

Available in clear, bronze or black anodized, mill finish or powder-coated.



C-107-8

Up to 500 lbs. [227 kg] per door



C-105-8

Up to 400 lbs. [181 kg] per door

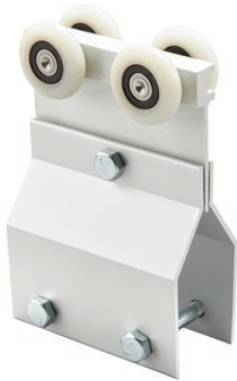

C-107-4

Up to 350 lbs. [159 kg] per door



C-105-4

Up to 200 lbs. [91 kg] per door



C-106-4

Up to 175 lbs. [79 kg] per door



How to Specify/Order:

Kit Code: [hanger series] x [track length] 1DR KIT

Note: [track length] = door width x 2 (for 1 door kits)

E.G. C-107-8 x 72" 1DR KIT



CEILING TRACK SYSTEMS

QUICK RELEASE HANGER



C-411

Up to 150 lbs. [68 kg] per door

This medium-duty Quick Release hanger comes standard with precision ball bearing, nylon tire wheels and allows for fast and easy installation. Levelling and adjusting the height is easy and only requires one person. For top mounted single, bi-parting, bypassing or pocket doors.

Available in clear, bronze or black anodized, mill finish or powder-coated.



TOP MOUNT HANGER



C-400

Up to 125 lbs. [57 kg] per door

This top mount hanger comes with our precision ball bearing, nylon tire wheels and is ideal for solid core doors. Features vertical adjustment by threaded door top plate and locknut. For top mounted single, bi-parting, bypassing or pocket doors.

Available in clear, bronze or black anodized, mill finish or powder-coated.



How to Specify/Order:

Kit Code: C-411-W X [track length] 1DR KIT (ideal for 1-3/4" [44.5 mm] doors)

Kit Code: C-411-B X [track length] 1DR KIT (ideal for 1-3/8" [34.9 mm] doors)

Kit Code: C-400-W X [track length] 1DR KIT (ideal for 1-3/4" [44.5 mm] doors)

Kit Code: C-400-B X [track length] 1DR KIT (ideal for 1-3/8" [34.9 mm] doors)

Note: [track length] = door width x 2 (for 1 door kits)



CEILING TRACK SYSTEMS

TOP MOUNT HANGER



C-350

Up to 75 lbs. [34 kg] per door

This light-duty series is top hung and features vertical adjustment by threaded door top plate and locknut. For top mounted single, bi-parting, bypassing, or pocket doors.

Available in clear, bronze or black anodized, mill finish or powder-coated.



CONCEALED HANGER



C-300

Up to 75 lbs. [34 kg] per door

This light-duty hanger is great for plywood or special material doors. The concealed track and hanger only require 1" [25.4 mm] of headroom and strongly anchors through the door. For top mounted single, bi-parting, bypassing, or pocket doors.

Available in clear, bronze or black anodized, mill finish or powder-coated.



How to Specify/Order:

Kit Code: C-350 X [track length] 1DR KIT

Kit Code: C-300 X [track length] 1DR KIT

Note: [track length] = door width x 2 (for 1 door kits)



BARN DOOR SYSTEMS

ZERO CLEARANCE HANGER



C-810

Up to 300 lbs. [136 kg] per door

This barn doors system allows for minimal clearance between the door and the track, reducing light and sound entry. Our nylon wheels with precision ball bearings ensure smooth and quiet door operation. This all-in-one kit comes with optional fascia and a wrench and Allen key for easy adjustment in the field.



How to Specify/Order:

Kit Code: C-810-108 x [track length] 1DR KIT

Optional Fascia Kit Code: C-810-110-CA x [track length] 1DR KIT

Note: [track length] = door width x 2 (for 1 door kits)



BARN DOOR SYSTEMS

QUICK RELEASE HANGER



C-911

Up to 200 lbs. [91 kg] per door

This heavy-duty hanger comes standard with nylon wheels and precision ball bearings for smooth and quiet door operation. Installation is fast and easy thanks to the Quick Release hanger assembly. Levelling and adjusting the height is also a breeze; only requiring one person. For single or bi-parting barn door applications.

Available in clear, bronze or black anodized or powder-coated.



How to Specify/Order:

Kit Code: C-911-108 x [track length] 1DR KIT

Optional Fascia Kit Code: C-911-110-CA x [track length] 1DR KIT

Note: [track length] = door width x 2 (for 1 door kits)



HEAVY-DUTY BARN DOOR SYSTEMS

NYLON WHEEL HANGERS

These barn door systems provide an uncomplicated look; hiding the track, hanger and any gaps. Our nylon wheels with precision ball bearings ensure smooth and quiet door operation.

Available in clear, bronze or black anodized or powder-coated.

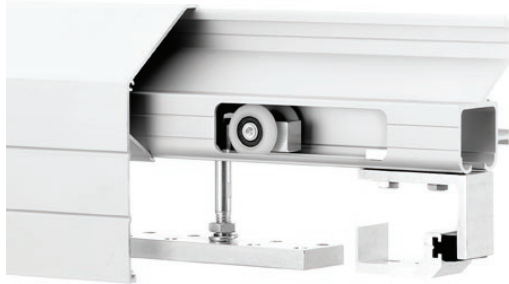

C-818HD-110

Up to 450 lbs. [204 kg] per door



C-994-110

Up to 350 lbs. [159 kg] per door



C-993-110

Up to 250 lbs. [113 kg] per door



How to Specify/Order:

Kit Code: [hanger series]-108 x [track length] 1DR KIT

Optional Fascia Kit Code: [hanger series]-110-CA x [track length] 1DR KIT

Note: [track length] = door width x 2 (for 1 door kits)



BARN DOOR SYSTEMS

NYLON WHEEL HANGERS

Precision ball bearing nylon wheels for smooth and quiet door operation. For single or bi-parting barn door applications.

Available in clear, bronze or black anodized or powder-coated.



C-106-4

Up to 175 lbs. [79 kg] per door



C-107-8

Up to 500 lbs. [227 kg] per door



C-105-8

Up to 400 lbs. [181 kg] per door

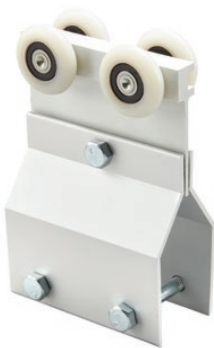

C-107-4

Up to 350 lbs. [159 kg] per door



C-105-4

Up to 200 lbs. [91 kg] per door



C-103-4

Up to 200 lbs. [91 kg] per door



How to Specify/Order:

Kit Code: [hanger series]-108 x [track length] 1DR KIT

Optional Fascia Kit Code: [hanger series]-110-CA x [track length] 1DR KIT

Note: [track length] = door width x 2 (for 1 door kits)



BYPASS SYSTEMS

TOP MOUNT HANGERS

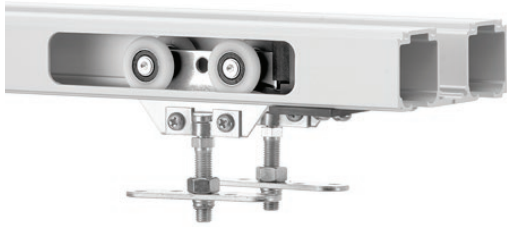

C-500

Up to 125 lbs. [57 kg] per door
For 1-3/4" [44.5 mm] thick doors



C-538

Up to 125 lbs. [57 kg] per door
For 1-3/8" [34.9 mm] thick doors



These top mount hangers come with our precision ball bearing, nylon tire wheels and is ideal for solid core doors. Features vertical adjustment by threaded door top plate and locknut.

Available in clear, bronze or black anodized, mill finish or powder-coated.



How to Specify/Order:

Kit Code: C-500-W x [track length] 2DR KIT

Kit Code: C-538-B x [track length] 2DR KIT

Optional Fascia Kit Code: C-500F-W x [track length] 2DR KIT

Optional Fascia Kit Code: C-538F-B x [track length] 2DR KIT

Note: [track length] = door width x 2 (for 2 door kits)



BYPASS SYSTEMS

TOP MOUNT HANGER



C-600

Up to 75 lbs. [34 kg] per door

This light-duty series is top hung and features vertical adjustment by threaded door top plate and locknut.

Available in clear, bronze or black anodized, mill finish or powder-coated.



CONCEALED HANGER



C-650

Up to 75 lbs. [34 kg] per door

This light-duty hanger is great for plywood or special material doors. The concealed track and hanger only require 1" [25.4 mm] of headroom and strongly anchors through the door.

Available in clear, bronze or black anodized, mill finish or powder-coated.



How to Specify/Order:

Kit Code: C-600 X [track length] 2DR KIT

Kit Code: C-650 X [track length] 2DR KIT

Note: [track length] = door width x 2 (for 2 door kits)



BYPASS SYSTEMS

SIDE MOUNT HANGERS



C-2035

Up to 60 lbs. [27 kg] per door



C-2025

Up to 60 lbs. [27 kg] per door



Interchangeable hangers allow this system to be used for 3/4" [19 mm] thick or 1-3/8" [34.9 mm] thick doors. Slotted holes on the hanger allow for vertical adjustment. Available with plain track or track with built-in fascia.



Available in clear, bronze or black anodized, mill finish or powder-coated.

How to Specify/Order:

Kit Code: C-2035-CA x [track length] 2DR KIT

Kit Code: C-2025 x [track length] 2DR KIT

Note: [track length] = door width x 2 (for 2 door kits)



CROWDER FOLDING SYSTEMS

CENTER PIVOT HANGER



C-180HD

Up to 250 lbs. [113 kg] per panel/leaf

These heavy-duty center pivoting hangers are used to create pivoting room dividers that can also be stacked back-to-back against a wall or within hide-away enclosures. Doors must be moved individually and cannot be hinged together.

Available in clear, bronze or black anodized, mill finish or powder-coated.



How to Specify/Order:

Please contact KN Crowder at customerservice@kncrowder.com or 1-866-999-1KNC(1562) for more information.



CROWDER FOLDING SYSTEMS

EASY CONNECT PIVOT KITS



CF-415

Up to 120 lbs. [54 kg] per panel/leaf

This medium-duty bi-folding kit comes with precision ball bearing, nylon tire wheels and our Easy Connect hangers. This combination ensures easy installation and adjustment, along with smooth and quiet door operation.



CF-515

Up to 150 lbs. [68 kg] per panel/leaf

This heavy-duty bi-folding kit comes with ball bearing steel wheels and our Easy Connect hangers, which allow for easy installation and adjustment.



How to Specify/Order:

Kit Code: CF-415 X [track length] 2DR KIT

Kit Code: CF-515 X [track length] 2DR KIT

Note: [track length] = door width x 2 (for 2 door kits)



CROWDER FOLDING SYSTEMS

PIVOT KITS

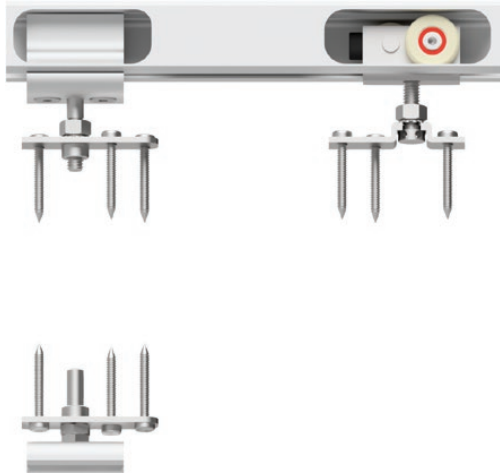

CF-115

Up to 50 lbs. [23 kg] per panel/door

This medium-duty system is great for bi-folding doors in constant use. The CF-115 hanger comes with ball bearing wheels with nylon tires, which allow for smooth operation. Hinges by others.



CF-100

Up to 20 lbs. [9 kg] per panel/door

Easy to install, this kit features our nylon wheels for smooth bi-folding movement. The spring-loaded pivot and nylon bushings allow for silent and easy use. Brackets are adjustable for plumb. Ideal for light or louvre type doors. Hinges by others.



How to Specify/Order:

Kit Code: CF-115 X [track length] 2DR KIT

Kit Code: CF-100 X [track length] 2DR KIT

Note: [track length] = door width x 2 (for 2 door kits)



CROWDER FOLDING SYSTEMS

TRACKLESS PIVOTS

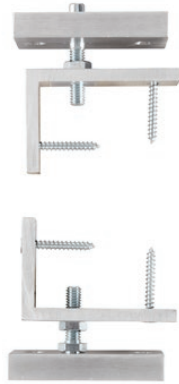

CF-116

Up to 50 lbs. [23 kg] per door

This medium to light-duty trackless pivot features angle brackets to be routed and recessed into the door.



CF-409

Up to 200 lbs. [91 kg] per door

This heavy-duty trackless pivot features all-steel zinc plated mounting plates along with thrust bearing on the bottom pivot plate.



How to Specify/Order:

Kit Code: CF-116

Kit Code: CF-409

DOOR GUIDE SYSTEMS

For 1-3/4" [44.5 mm] Thick Doors (or greater)



C-914 GUIDE CHANNEL
1" [25.4 mm] wide x 29/32" [23 mm] high



C-913 FLOOR GUIDE
Single Round Bar Handle Pull
2" [50.8 mm] wide x 1" [25.4 mm] high



C-913-2 DOUBLE ROLLER FLOOR GUIDE
4" [101.6 mm] wide x 1" [25.4 mm] high



CSM-913-2HD SIDE MOUNT GUIDE
3" [76.2 mm] wide x 3" [76.2 mm] high



C-913SL SPRING LOADED GUIDE
Plate 3" [76.2 mm] long x 1-1/4" [31.8 mm] wide
Hole size required in door \varnothing 3/4" [19.1 mm] x
MIN. 3" [76.2 mm] deep



CSM-913 SIDE MOUNT GUIDE
1-3/4" [44.5 mm] wide x 1-1/2" [38.1 mm] high
Distance from wall to center of guide 1-1/2" [38.1 mm]



C-202 DOUBLE GROOVE GUIDE THRESHOLD
4-1/4" [108 mm] wide x 9/16" [14.3 mm] high
C-202S DOUBLE GROOVE SLOPED GUIDE THRESHOLD
5-11/32" [135.4 mm] wide x 9/16" [14.3 mm] high

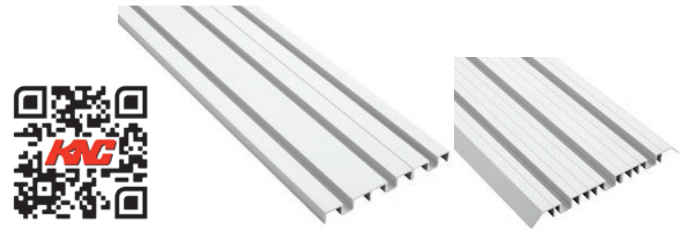
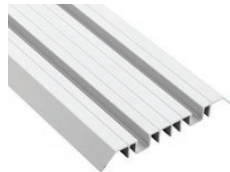

C-202-3 TRIPLE GROOVE GUIDE THRESHOLD
6-3/16" [157.2 mm] wide x 9/16" [14.3 mm] high
C-202S-3 TRIPLE GROOVE SLOPED GUIDE THRESHOLD
7-15/32" [189.4 mm] wide x 9/16" [14.3 mm] high



C-200 GUIDE
2" [50.8 mm] wide x 3/4" [19.1 mm] high



C-913D-134 BYPASS GUIDE
1-1/2" [38.1 mm] wide x 13/16" [20.6 mm] high
Center to Center of guides 2-1/8" [54 mm]



C-200B SPRING LOADED GUIDE
Body 1-3/8" [34.9 mm] long x 5/8" [15.9 mm] wide
Hole size required in door \varnothing 1/2" [12.7 mm] x 13/16" [20.6 mm] deep

DOOR GUIDE SYSTEMS

For 1-3/8" [34.9 mm] Thick Doors (or smaller)



C-201 GUIDE CHANNEL
5/8" [15.5 mm] wide x 3/4" [19.0 mm] high

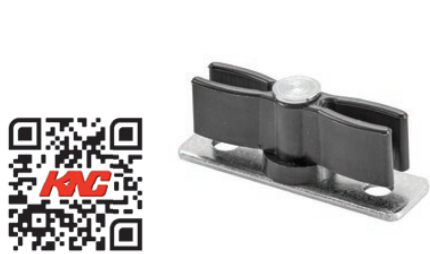

C-200 GUIDE
2" [50.8 mm] wide x 3/4" [19.1 mm] high



C-200B SPRING LOADED GUIDE
Body 1-3/8" [34.9 mm] long x 5/8" [15.9 mm] wide
Hole size required in door Ø 1/2" [12.7 mm] x 13/16" [20.6 mm] deep



CSM-200 SIDE MOUNT GUIDE
1-3/4" [44.5 mm] wide x 1-1/2" [38.1 mm] high
Distance from wall to center of guide 1-1/2" [38.1 mm]

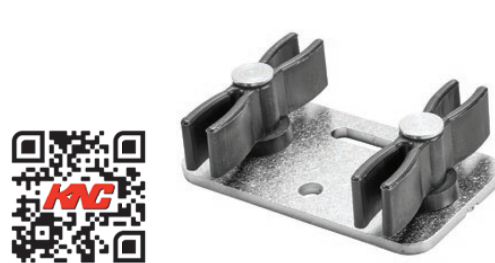

C200D-138 BYPASS GUIDE
1-1/2" [38.1 mm] wide x 13/16" [20.6 mm] high
Center to Center of guides 1-3/4" [44.5 mm]



C-1205 NYLON GUIDE
Large piece 2-7/8" [73 mm] long x 1-1/8" [28.6 mm] wide x 3/4" [19.1 mm] high
Small piece 1-7/16" [36.5 mm] long x 5/8" [15.9 mm] wide x 3/4" [19.1 mm] high



C-1201 CENTER NYLON GUIDE
1-3/4" [44.5 mm] long x 1/2" [12.7 mm] wide x 3/4" [19.1 mm] high



C-1202 OFFSET NYLON GUIDE
1-3/4" [44.5 mm] long x 1/2" [12.7 mm] wide x 3/4" [19.1 mm] high

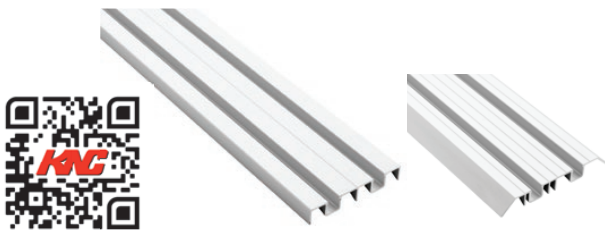

C-238 DOUBLE GROOVE GUIDE THRESHOLD
3-1/2" [88.9 mm] wide x 9/16" [14.3 mm] high
C-238S DOUBLE GROOVE SLOPED GUIDE THRESHOLD
4-19/32" [116.4 mm] wide x 9/16" [14.3 mm] high



C-238-3 TRIPLE GROOVE GUIDE THRESHOLD
5-7/16" [138.1 mm] wide x 9/16" [14.3 mm] high
C-238S-3 TRIPLE GROOVE SLOPED GUIDE THRESHOLD
6-11/32" [160.8 mm] wide x 9/16" [14.3 mm] high



PRIVACY LOCK SETS
DOOR LOCKS & PULLS



C-90L-ET

Privacy Lock & Edge Pull Set



C-90L-OT

Occupancy Privacy Lock & Edge Pull Set



C-92L-ET

Privacy Lock Set



C-92L-OT

Occupancy Privacy Lock Set



How to Specify/Order:

Lock Series x Finish

Please see pages 156-157 for available finishes.

PRIVACY LOCK SETS



C-80L-ET

Privacy Lock & Edge Pull Set



C-60L-RET

Privacy Lock & Edge Pull Set



C-60L-SET

Privacy Lock & Edge Pull Set



How to Specify/Order:

Lock Series x Finish

Please see pages 156-157 for available finishes.

PRIVACY LOCK SETS



C-62L-RET
Privacy Lock Set



C-62L-SET
Privacy Lock Set



C-35
Round Privacy Lock & Edge Pull Set



C-30
Privacy Lock & Edge Pull Set



How to Specify/Order:

Lock Series x Finish

Please see pages 156-157 for available finishes.



SECURITY LOCK SETS
DOOR LOCKS & PULLS



C-90L-CT

Security Lock & Edge Pull Set



C-90L-CC

Double Security Lock & Edge Pull Set



C-92L-CT

Security Lock Set



C-92L-CC

Double Security Lock Set



C-80L-CT

Security Lock & Edge Pull Set



How to Specify/Order:

Lock Series x Finish

Please see pages 156-157 for available finishes.



PASSAGE SETS
DOOR LOCKS & PULLS



C-91-BB

Edge Pull With Blank Flush Pulls



C-91-BHBH

Edge Pull With Blank Flush Pulls With Swing Out Handles



How to Specify/Order:

Lock Series x Finish

Please see pages 156-157 for available finishes.

PASSAGE SETS



C-21-BB

Edge Pull with Blank Flush Pulls



C-2180

Edge Pull with Blank Flush Pulls



C-2171

Edge Pull with Blank Flush Pulls



C-2172

Edge Pull with Blank Flush Pulls



How to Specify/Order:

Lock Series x Finish

Please see pages 156-157 for available finishes.

PASSAGE SETS



C-23

Wood Door Pull for 1-3/8"



C-25

Wood Door Pull for 1-3/4"



C-34

Edge Pull with Round Passage Door Pulls



C-40

Edge Pull with Passage Door Pulls



How to Specify/Order:

Lock Series x Finish

Please see pages 156-157 for available finishes.

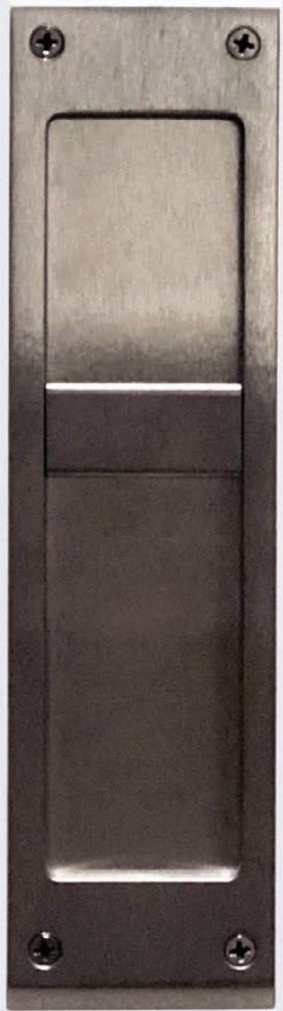

BI-PARTING LOCK AND PASSAGE SETS

DOOR LOCKS & PULLS



C-90S-BB

Passage Strike & Edge Pull Set



C-90L-ET

Privacy Lock & Edge Pull Set



C-90L-OT

Occupancy Privacy Lock & Edge Pull Set



C-90L-CT

Security Lock & Edge Pull Set



How to Specify/Order:

Lock Series x Finish

Please see pages 156-157 for available finishes.



BARRIER FREE (ADA COMPLIANT) LOCK SETS
DOOR LOCKS & PULLS



C-92L-HLDP

Complete Barrier Free (ADA Compliant) Privacy Lock Set



C-92L-HL

Barrier Free (ADA Compliant) Privacy Lock Set



C-50P

Barrier Free (ADA Compliant) Pocket Passage Pulls



C-50FP

Full Privacy, Barrier Free (ADA Compliant) Pocket Lock Set



How to Specify/Order:

Lock Series x Finish

Please see pages 156-157 for available finishes.



BARN DOOR LOCK SETS
DOOR LOCKS & PULLS



C-94BL-ET
Barn Door Privacy Lock Set



C-94BL-CT
Barn Door Security Lock Set



C-94BL-OT
Barn Door Occupancy Privacy Lock Set

How to Specify/Order:

Lock Series x Finish

Please see pages 156-157 for available finishes.

BARN DOOR LOCK SETS



C-94BL-HLDP

Complete Barrier Free (ADA Compliant) Barn Door Lock Set



C-94BL-HL

Barrier Free (ADA Compliant) Barn Door Lock Set



How to Specify/Order:

Lock Series x Finish

Please see pages 156-157 for available finishes.

BARN DOOR LOCK SETS



C-94BL-SET

Barn Door Privacy Lock Set



C-54BL

Round Barrier Free (ADA Compliant)
Privacy Barn Door Lock Set



How to Specify/Order:

Lock Series x Finish

Please see pages 156-157 for available finishes.



SELF-LATCHING LOCK SETS
DOOR LOCKS & PULLS



C-95SL-CHL

Self-Latching Barrier Free (ADA Compliant)
Cylinder & Handle Lever Lock Set



C-95SL-OIHL

Self-Latching Barrier Free (ADA Compliant)
Handle Lever & Occupancy Indicator Lock Set



C-95SL-CT

Self-Latching Flush Pull Cylinder & Handle
Lever Lock Set



C-95SL-OT

Self-Latching Flush Pull Thumb Turn & Occupancy
Indicator Lock Set



How to Specify/Order:

Lock Series x Finish

Please see pages 156-157 for available finishes.

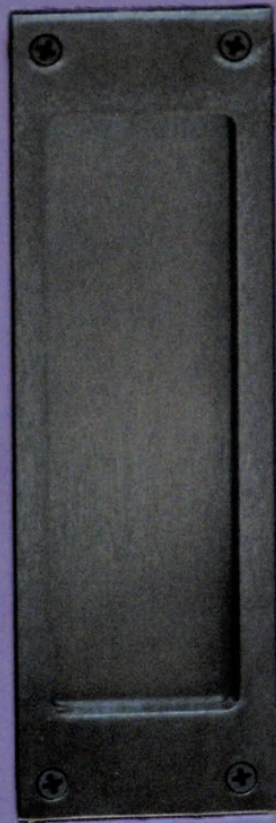

FLUSH PULLS
DOOR LOCKS & PULLS



C-90B



C-90BH



C-80B



C-71



C-72



C-60RB



C-60SB



How to Specify/Order:

Lock Series x Finish

Please see pages 156-157 for available finishes.



EDGE PULLS
DOOR LOCKS & PULLS



C-91



C-61



C-21



How to Specify/Order:

Lock Series x Finish

Please see pages 156-157 for available finishes.



GLASS DOOR PULLS
DOOR LOCKS & PULLS



CGP-012
For 1/2" [12 mm] glass



CGP-038
For 3/8" [10 mm] glass



How to Specify/Order:

Lock Series x Finish

Please see pages 156-157 for available finishes.



DOOR HANDLE PULLS
DOOR LOCKS & PULLS



C-90DP
Double Handle Pulls
7-3/4" [197 mm]



C-90SP
Single Handle Pull
7-3/4" [197 mm]



How to Specify/Order:

Lock Series x Finish

Please see pages 156-157 for available finishes.

DOOR HANDLE PULLS



CFT-DP36/DP18 x 630
Double Flat Bar Handle Pulls
(36" [914 mm] or 18" [457 mm])

CFT-SP36/SP18 X 630
Single Flat Bar Handle Pull
(36" [914 mm] or 18" [457 mm])



CFT-DP36/DP18 X 622
Double Flat Bar Handle Pulls
(36" [914 mm] or 18" [457 mm])

CFT-SP36/SP18 X 622
Single Flat Bar Handle Pull
(36" [914 mm] or 18" [457 mm])

How to Specify/Order:

Lock Series x Finish

Please see pages 156-157 for available finishes.

DOOR HANDLE PULLS



CRT-DP36/DP18 X 630
Double Round Bar Handle Pulls
(36" [914 mm] or 18" [457 mm])

CRT-SP36/SP18 X 630
Single Round Bar Handle Pull
(36" [914 mm] or 18" [457 mm])



CRT-DP36/DP18 X 622
Double Round Bar Handle Pulls
(36" [914 mm] or 18" [457 mm])

CRT-SP36/SP18 X 622
Single Round Bar Handle Pull
(36" [914 mm] or 18" [457 mm])

How to Specify/Order:

Lock Series x Finish

Please see pages 156-157 for available finishes.

DOOR LOCKS & PULLS COLOUR CHART



626
Dull Chrome

605
Bright Brass

606
Dull Brass

613
Oil Rubbed Bronze

618
Bright Nickel Plated

	626 Dull Chrome	605 Bright Brass	606 Dull Brass	613 Oil Rubbed Bronze	618 Bright Nickel Plated
C-21	X	X	X	X	-
C-2171	X	X	-	X	-
C-2172	X	X	-	X	-
C-2180	X	X	X	X	-
C-21-BB	X	X	X	X	-
C-23	-	-	-	-	-
C-25	-	-	-	-	-
C-30	X	X	X	X	-
C-34	X	X	X	X	-
C-35	X	X	X	X	-
C-40	X	X	X	X	-
C-50 Series	-	-	-	-	-
C-54BL	X	-	X	X	-
C-60 Series	X	X	X	X	X
C-61	X	X	X	X	X
C-62 Series	X	X	X	X	X
C-71	X	X	-	X	-
C-72	X	X	-	X	-
C-80 Series	X	X	X	X	X
C-90 Series	X	X	X	X	X
C-91 Series	X	X	X	X	X
C-92 Series	X	X	X	X	X
C-94 Series	X	X	X	X	X
C-95 Series	X	X	X	X	X
CFT Series	-	-	-	-	-
CRT Series	-	-	-	-	-
CGP Series	-	-	-	-	-

DOOR LOCKS & PULLS COLOUR CHART



619
Dull Nickel Plated

622
Flat Black Coated

625
Bright Chrome

630
Satin Stainless Steel

WH
White Powder Coat

	619 Dull Nickel Plated	622 Flat Black Coated	625 Bright Chrome	630 Satin Stainless Steel	WH White Powder Coat
C-21	X	X	X	-	X
C-2171	-	X	-	-	-
C-2172	-	X	-	-	-
C-2180	X	X	X	-	-
C-21-BB	X	X	X	-	-
C-23	-	X	-	X	-
C-25	-	X	-	X	-
C-30	X	X	X	-	X
C-34	X	X	X	-	-
C-35	X	X	X	-	-
C-40	X	X	X	-	X
C-50 Series	-	X	-	X	-
C-54BL	-	-	-	X	X
C-60 Series	X	X	X	-	-
C-61	X	X	X	-	-
C-62 Series	X	X	X	-	-
C-71	-	X	-	-	-
C-72	-	X	-	-	-
C-80 Series	X	X	X	-	-
C-90 Series	X	X	X	-	-
C-91 Series	X	X	X	-	-
C-92 Series	X	X	X	-	-
C-94 Series	X	X	X	-	-
C-95 Series	X	X	X	-	-
CFT Series	-	X	-	X	-
CRT Series	-	X	-	X	-
CGP Series	-	X	-	X	-

REALLY??? YES WE CAN



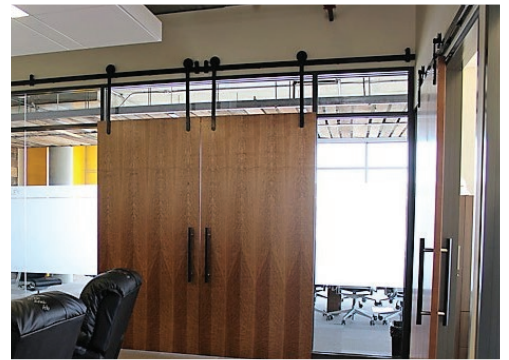

Other Products by K.N. Crowder Mfg. Inc.

KNC
K.N.CROWDER MFG. INC.

K. N. CROWDER MFG. INC.

70 YEARS
K.N. CROWDER MFG. INC.

WEATHERSTRIP
THRESHOLDS
AUTOMATIC DOOR BOTTOMS
ASTRAGALS
STAIR NOSINGS

Family owned and operated for over 70 years
www.kncrowder.com

KNC
K.N.CROWDER mfg.inc.
www.kncrowder.com

65 years of quality & service
KNC

Door Lites
Door Louvers

Trusted by Canada's busiest airport

KNC
K.N.CROWDER mfg.inc.

kenagritte and ken-a-mat

Dimensionally permanent, dependable Foot Grilles and Floor Mats for all applications
by K.N. Crowder Mfg. Inc.

65 years of quality & service
KNC

"Dura-Spaced" Foot Grilles and Floor Mats

www.kncrowder.com



KNC
K.N.CROWDER MFG. INC.

K.N. CROWDER MFG. INC.
1220 Burloak Drive,
Burlington, Ontario L7L 6B3

K.N. CROWDER INC.
210 Eighth Street South
Lewiston, New York 14092

Toll Free Tel: 1 866 999 1KNC (1562)
Email: customerservice@kncrowder.com